

2024

Illustrated Price List

Effective April 1, 2024

USA





Dear Tile Professional,

Constant development of innovative solutions for ceramic tile and natural stone installations is the cornerstone of our tradition at Schluter. The Illustrated Price List, which you hold in your hands, features new and improved products that reflect that tradition.

A perfect example is Schluter®-SCHIENE, which became the foundation of Schluter's success in 1975. In our tradition of innovation, the simple right-angle profile has since evolved to include an integrated joint spacer. Often, small details result in large advantages for the installer. In this case, the integrated joint spacer makes tile setting easier and cleaner. Gradually, all of our products will be equipped with this feature.

To a large degree, Schluter-Systems owes its position as market leader to you, our industry partner. Your input has helped us improve on the function, aesthetic appeal, and safety of our products. Hence, we will keep our ear to the market, so that we may continue to deliver high quality, professional products to specifiers and architects, distributors and dealers, contractors and owners.

Sincerely,

Werner Schlüter



1975 - 1981



1981 - 2000

















2000 - present

Did You Know?

This price list contains interactive links!



-  Product Overview 4 - 11
-  Finishing, edge-protection, & transition profiles for floors 12 - 21
-  Finishing & edge-protection profiles for walls & countertops 22 - 59
-  Stair-nosing profiles 60 - 71
-  Movement joint & cove-shaped profiles 72 - 92
-  Profiles for resilient floor & wall coverings 93 - 97
-  Waterproof substrates & building panels 98 - 106
-  Waterproofing & uncoupling membranes 107 - 113
-  Removable fleece 114 - 115
-  Electric floor warming system 116 - 123
-  Shower system 124 - 179
-  Modular screed system for conventional & radiant-heated screeds 180 - 182
-  Setting materials 183 - 186
-  Tools 187 - 188

Click or tap in the table of contents to jump to a section.

Click or tap in the alphabetical or picture index to jump to a specific product.

The screenshot shows the 'CONTENTS' table of contents on the left, with a hand cursor icon over the 'Finishing & edge-protection profiles for walls & countertops' section. Below it is a product page for 'Schluter Profiles' with a photo of a kitchen countertop edge.

The screenshot shows two main sections: 'PRODUCT LIST IN ALPHABETICAL ORDER' with a grid of product codes and names, and 'FINISHING, EDGE-PROTECTION & TRANSITION PROFILES FOR FLOORS' and 'FINISHING & EDGE-PROTECTION PROFILES FOR WALLS & COUNTERTOPS' with a grid of product images. A hand cursor icon is over one of the images.

On any page, click or tap the INDEX button at the top to jump back to the table of contents.



What's New?



KERDI-BOARD-SNLT & LIPROTEC
pages 158-159

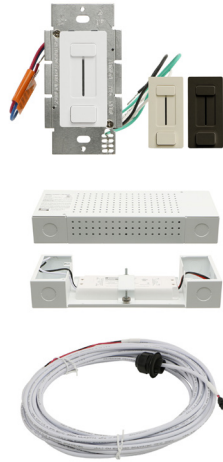

KERDI-LINE-VARIO
pages 150-151

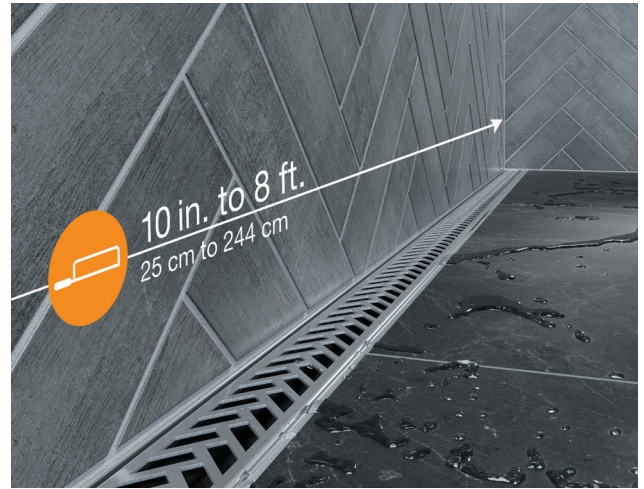

DILEX-F
page 75



TREP-V
page 67



PRIMER-U
page 186

New Size!



New Colors!

DECO-SG
page 47

















KERDI-DRAIN-STYLE
page 133



SHELF
pages 166-175



	Product Overview	4 - 11
	Finishing, edge-protection, & transition profiles for floors	12 - 21
	Finishing & edge-protection profiles for walls & countertops	22 - 59
	Stair-nosing profiles	60 - 71
	Movement joint & cove-shaped profiles	72 - 92
	Profiles for resilient floor & wall coverings	93 - 97
	Waterproof substrates & building panels	98 - 106
	Waterproofing & uncoupling membranes	107 - 113
	Removable fleece	114 - 115
	Electric floor warming system	116 - 123
	Shower system	124 - 179
	Modular screed system for conventional & radiant-heated screeds	180 - 182
	Setting materials	183 - 186
	Tools	187 - 188



A

Schluter®-ALL-SET 184

B

Schluter®-BEKOTEC 181

Schluter®-BEKOTEC-BRS 182

Schluter®-BEKOTEC-BRSK 182

Schluter®-BEKOTEC-BRS/KF 182

Schluter®-BEKOTEC-BRS/KSF 182

Schluter®-BEKOTEC-F 181

Schluter®-BEKOTEC-THERM-RH 75 182

D

Schluter®-DECO 16

Schluter®-DECO-DE 44

Schluter®-DECO-SG 47 & 178

Schluter®-DECO-SGC 48 & 179

Schluter®-DESIGNBASE-SL 58 - 59

Schluter®-DESIGNLINE 46

Schluter®-DILEX-AHK 84 - 86

Schluter®-DILEX-AHKA 87 - 88

Schluter®-DILEX-AKWS 76

Schluter®-DILEX-AS 79

Schluter®-DILEX-BT 78

Schluter®-DILEX-BTO 78

Schluter®-DILEX-BTS 79

Schluter®-DILEX-BWA 80

Schluter®-DILEX-BWB 75

Schluter®-DILEX-BWS 74

Schluter®-DILEX-DFP 182

Schluter®-DILEX-EDP 77

Schluter®-DILEX-EHK 90

Schluter®-DILEX-EKE 81

Schluter®-DILEX-EKSB 77

Schluter®-DILEX-EZ 6 + 9 74

▲ Schluter®-DILEX-F 75

Schluter®-DILEX-HK 83

Schluter®-DILEX-HKS 91

Schluter®-DILEX-HKU 92

Schluter®-DILEX-HKW 82

Schluter®-DILEX-KSA 80

Schluter®-DILEX-KSN 76

Schluter®-DILEX-MOP 73

Schluter®-DILEX-MP/-MPV 73

Schluter®-DILEX-PHK 89

Schluter®-DITRA 108

Schluter®-DITRA-HEAT 117

Schluter®-DITRA-HEAT-DUO 117

Schluter®-DITRA-HEAT-DUO-PS 118

Schluter®-DITRA-HEAT-E-HK 119

Schluter®-DITRA-HEAT-E-R 122

Schluter®-DITRA-HEAT-E-RR 122

Schluter®-DITRA-HEAT-E-RRS 123

Schluter®-DITRA-HEAT-E-RS1 123

Schluter®-DITRA-HEAT-E-RT 122

Schluter®-DITRA-HEAT-E-WiFi 122

Schluter®-DITRA-HEAT-PS 118

Schluter®-DITRA-HEAT/-DITRA-XL-TROWEL 187

Schluter®-DITRA-ROLLER 187

Schluter®-DITRA-TROWEL 187

Schluter®-DITRA-XL 108

E

Schluter®-ECK-E 54

Schluter®-ECK-K 55

Schluter®-ECK-KHK 56

Schluter®-ECK-KI 57

F

Schluter®-FAST-SET 184

Schluter®-FINEC 43

Schluter®-FINEC-SQ 42

I

Schluter®-INDEC 44

J

Schluter®-JOLLY 23 - 26

Schluter®-JOLLY-P 27

K

Schluter®-KERDI 110 & 125

Schluter®-KERDI-BAND 106, 111 & 126

Schluter®-KERDI-BOARD 99

Schluter®-KERDI-BOARD-E 100

Schluter®-KERDI-BOARD-KIT 164

Schluter®-KERDI-BOARD-SB 101 & 156

Schluter®-KERDI-BOARD-SC 101 & 155

Schluter®-KERDI-BOARD-SN 102 & 156

▲ Schluter®-KERDI-BOARD-SNLT 158

Schluter®-KERDI-BOARD-U 100

Schluter®-KERDI-BOARD-V 100

Schluter®-KERDI-BOARD-ZA 103

Schluter®-KERDI-BOARD-ZB 104

Schluter®-KERDI-BOARD-ZC 103

Schluter®-KERDI-BOARD-ZDK 106

Schluter®-KERDI-BOARD-ZFP 105

Schluter®-KERDI-BOARD-ZS 105

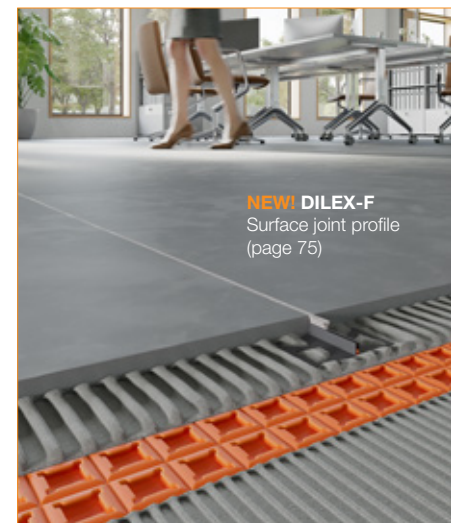

NEW! DILEX-F
Surface joint profile
(page 75)

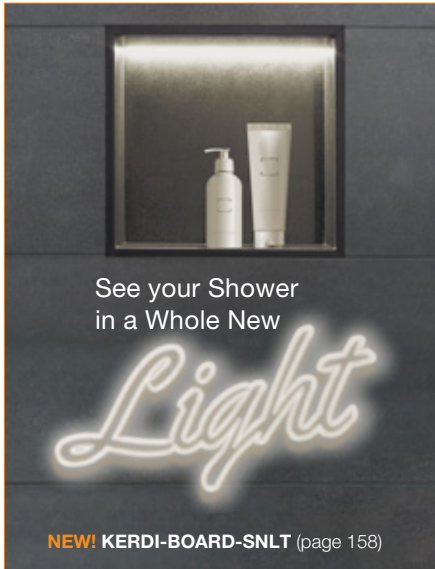

Schluter®-KERDI-BOARD-ZSA ... 106 & 115

Schluter®-KERDI-BOARD-ZSD 104

Schluter®-KERDI-BOARD-ZT 105

Schluter®-KERDI-BOARD-ZW 104

Schluter®-KERDI-DRAIN 130 - 140

Schluter®-KERDI-DRAIN-F 141

Schluter®-KERDI-DS 110 & 125

Schluter®-KERDI-FIX 113 & 179

Schluter®-KERDI-FLEX 109

Schluter®-KERDI-KERECK-F 111 & 126

Schluter®-KERDI-KERS 112 & 127

Schluter®-KERDI-KERS-B 112 & 127

Schluter®-KERDI-KM 113 & 128

Schluter®-KERDI-LINE 144 - 149

Schluter®-KERDI-LINE-FC 149

▲ Schluter®-KERDI-LINE-VARIO ... 150 - 151

Schluter®-KERDI-SEAL-PS/-MV ... 113 & 128

Schluter®-KERDI-SHOWER-CB 137

Schluter®-KERDI-SHOWER-KIT ... 160 - 162

Schluter®-KERDI-SHOWER-LT/-LTS 154

Schluter®-KERDI-SHOWER-R 155

Schluter®-KERDI-SHOWER-T/-TS/-TT 153

Schluter®-KERDI-TROWEL 187

Schluter®-KERDI-TUBKIT 163

L

▲ Schluter®-LIPROTEC-CW 159

▲ Schluter®-LIPROTEC-ECD 159

▲ Schluter®-LIPROTEC-ECX 159

P

Schluter®-PRIMER-U 186

Schluter®-PROCUT-TSM 188

Q

Schluter®-QUADEC 37 - 40

Schluter®-QUADEC-FS 41

Schluter®-QUADEC-K 41

R

Schluter®-REFLEECE 115

Schluter®-REMA 57

Schluter®-RENO-RAMP 20

Schluter®-RENO-RAMP-K 20

Schluter®-RENO-T 17

Schluter®-RENO-TK 18

Schluter®-RENO-U 21

Schluter®-RENO-V 19

Schluter®-RONDEC 28 - 36

Schluter®-RONDEC-CT 51 - 52

Schluter®-RONDEC-DB 45

Schluter®-RONDEC-STEP ... 49 - 51 & 61 - 62

S

Schluter®-SCHIENE 13 - 15 & 27

Schluter®-SCHIENE-STEP 53 & 63

Schluter®-SET 184

Schluter®-SHELF 166 - 175

Schluter®-SHOWERPROFILE-R 176

Schluter®-SHOWERPROFILE-S 176

Schluter®-SHOWERPROFILE-WS 177

Schluter®-SHOWERPROFILE-WSK 177

Schluter®-SNIPS 188

T

Schluter®-TREP-E 65

Schluter®-TREP-EFK 70

Schluter®-TREP-EK 70

Schluter®-TREP-FL 64

Schluter®-TREP-G 66

Schluter®-TREP-GK 71

Schluter®-TREP-SE/-S/-B 68

Schluter®-TREP-TAP 69

▲ Schluter®-TREP-V 67

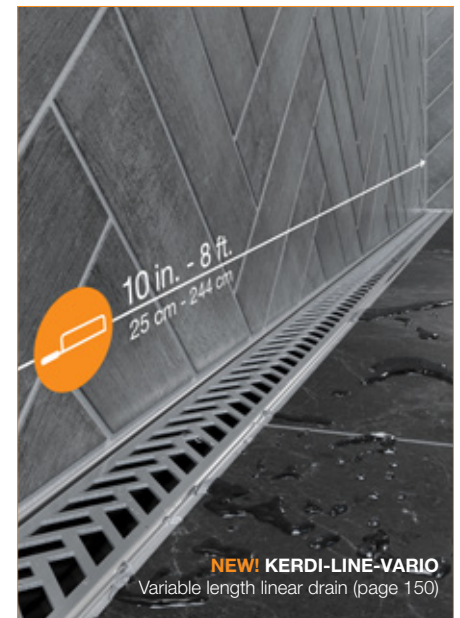

V

Schluter®-VINPRO-RO 96

Schluter®-VINPRO-S 94

Schluter®-VINPRO-STEP 97

Schluter®-VINPRO-STEP-R 97

Schluter®-VINPRO-T 94

Schluter®-VINPRO-U 95



Schluter®-SCHIENE
Page 13 - 15



Schluter®-DECO
Page 16



Schluter®-RENO-T
Page 17



Schluter®-RENO-TK
Page 18



Schluter®-RENO-V
Page 19



Schluter®-RENO-RAMP/-K
Page 20



Schluter®-RENO-U
Page 21



Schluter®-JOLLY
Page 23 - 26



Schluter®-JOLLY-P
Page 27



Schluter®-SCHIENE
Page 27



Schluter®-RONDEC
Page 28 - 36



Schluter®-QUADEC
Page 37 - 40



Schluter®-QUADEC-K
Page 41



Schluter®-QUADEC-FS
Page 41



Schluter®-FINEC-SQ
Page 42



Schluter®-FINEC
Page 43



Schluter®-INDEC
Page 44



Schluter®-DECO-DE
Page 44

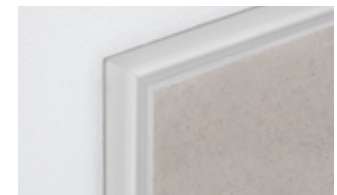

Schluter®-RONDEC-DB
Page 45



Schluter®-DESIGNLINE
Page 46



Schluter®-DECO-SG
Page 47



Schluter®-DECO-SGC
Page 48

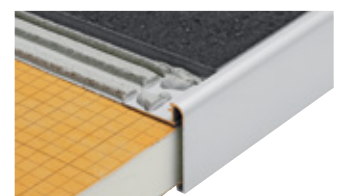

Schluter®-RONDEC-STEP
Page 49 - 51

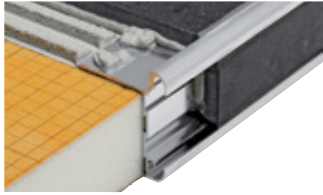

Schluter®-RONDEC-CT
Page 51 - 52

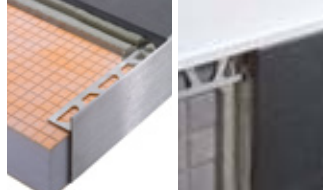

Schluter®-SCHIENE-STEP
Page 53



Schluter®-ECK-E
Page 54

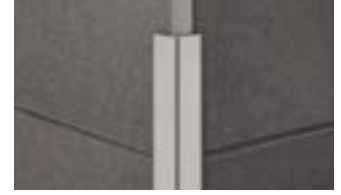

Schluter®-ECK-K
Page 55



Schluter®-ECK-KHK
Page 56



Schluter®-ECK-KI
Page 57



Schluter®-REMA
Page 57



Schluter®-DESIGNBASE-SL
Page 58 - 59

STAIR-NOSING PROFILES

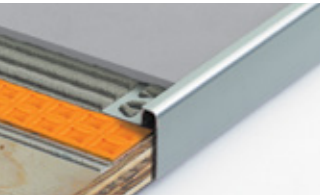

Schluter®-RONDEC-STEP
Page 61 - 62

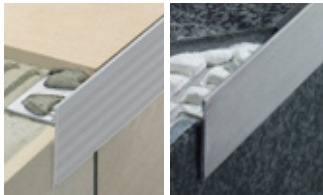

Schluter®-SCHIENE-STEP
Page 63



Schluter®-TREP-FL
Page 64



Schluter®-TREP-E
Page 65



Schluter®-TREP-G
Page 66



 Schluter®-TREP-V
Page 67

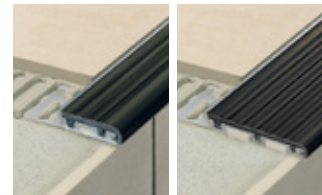

Schluter®-TREP-SE/-S/-B
Page 68

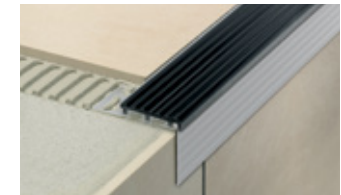

Schluter®-TREP-TAP
Page 69

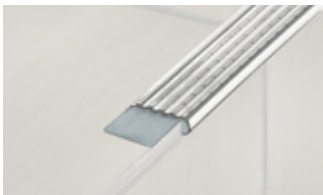

Schluter®-TREP-EK
Page 70



Schluter®-TREP-EFK
Page 70

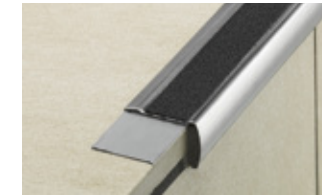

Schluter®-TREP-GK
Page 71



Schluter®-DILEX-MOP
Page 73



Schluter®-DILEX-MP/-MPV
Page 73



Schluter®-DILEX-EZ 6 + 9
Page 74



Schluter®-DILEX-BWS
Page 74



Schluter®-DILEX-BWB
Page 75

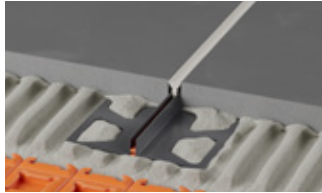

 Schluter®-DILEX-F
Page 75



Schluter®-DILEX-KSN
Page 76



Schluter®-DILEX-AKWS
Page 76



Schluter®-DILEX-EKSB
Page 77



Schluter®-DILEX-EDP
Page 77



Schluter®-DILEX-BT
Schluter®-DILEX-BTO
Page 78



Schluter®-DILEX-BTS
Page 79



Schluter®-DILEX-AS
Page 79



Schluter®-DILEX-BWA
Page 80



Schluter®-DILEX-KSA
Page 80

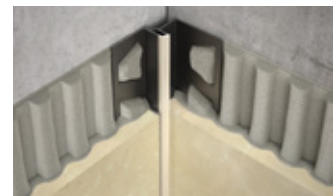

Schluter®-DILEX-EKE
Page 81



Schluter®-DILEX-HKW
Page 82



Schluter®-DILEX-HK
Page 83



Schluter®-DILEX-AHK
Page 84 - 86



Schluter®-DILEX-AHKA
Page 87 - 88



Schluter®-DILEX-PHK
Page 89



Schluter®-DILEX-EHK
Page 90



Schluter®-DILEX-HKS
Page 91



Schluter®-DILEX-HKU
Page 92



Schluter®-VINPRO-S
Page 94



Schluter®-VINPRO-T
Page 94



Schluter®-VINPRO-U
Page 95



Schluter®-VINPRO-RO
Page 96



Schluter®-VINPRO-STEP
Page 97



Schluter®-VINPRO-STEP-R
Page 97

WATERPROOF SUBSTRATES & BUILDING PANELS

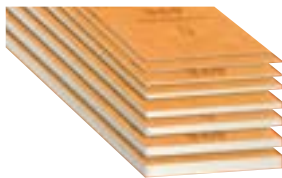

Schluter®-KERDI-BOARD
Page 99

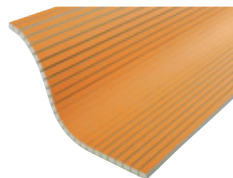

Schluter®-KERDI-BOARD-V
Page 100

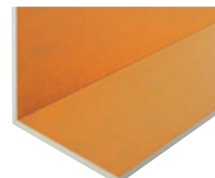

Schluter®-KERDI-BOARD-E
Page 100

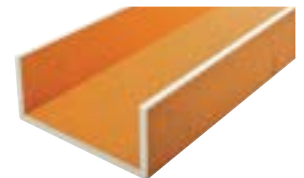

Schluter®-KERDI-BOARD-U
Page 100



Schluter®-KERDI-BOARD-SC
Page 101



Schluter®-KERDI-BOARD-SB
Page 101



Schluter®-KERDI-BOARD-SN
Page 102



Schluter®-KERDI-BOARD-ZC
Page 103

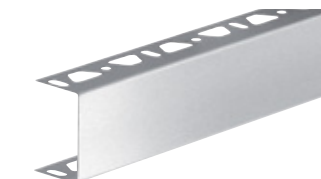

Schluter®-KERDI-BOARD-ZA
Page 103

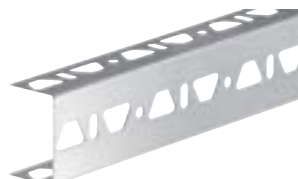

Schluter®-KERDI-BOARD-ZB
Page 104



Schluter®-KERDI-BOARD-ZW
Page 104



Schluter®-KERDI-BOARD-ZSD
Page 104

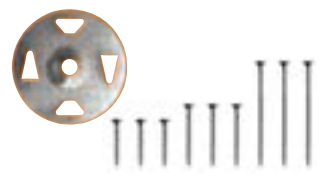

Schluter®-KERDI-BOARD-ZT/-ZS
Page 105



Schluter®-KERDI-BOARD-ZFP
Page 105



Schluter®-KERDI-BAND
Page 106

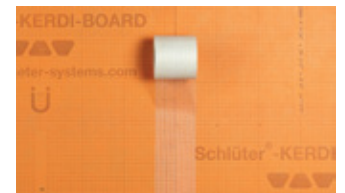

Schluter®-KERDI-BOARD-ZSA
Page 106



Schluter®-KERDI-BOARD-ZDK
Page 106



Schluter®-DITRA
Page 108



Schluter®-DITRA-XL
Page 108



Schluter®-KERDI-FLEX
Page 109



Schluter®-KERDI-DS
Page 110



Schluter®-KERDI-BAND
Page 111

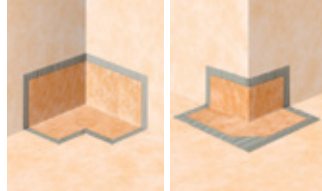

Schluter®-KERDI-KERECK-F
Page 111



Schluter®-KERDI-KERS-B
Page 112

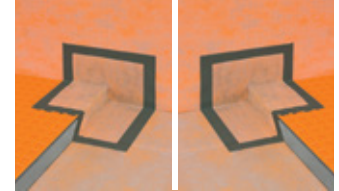

Schluter®-KERDI-KERS
Page 112

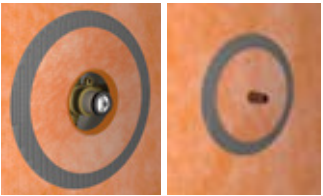

Schluter®-KERDI-SEAL-PS/-MV
Page 113



Schluter®-KERDI-KM
Page 113



Schluter®-KERDI-FIX
Page 113



Schluter®-REFLEECE
Page 115

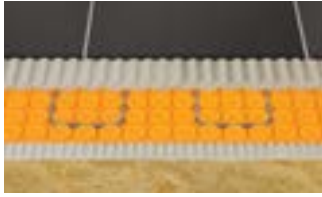

Schluter®-DITRA-HEAT
Page 117

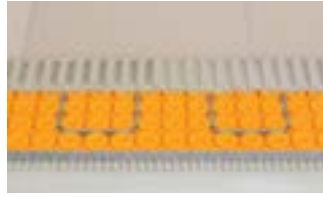

Schluter®-DITRA-HEAT-DUO
Page 117



Schluter®-DITRA-HEAT-PS
Page 118

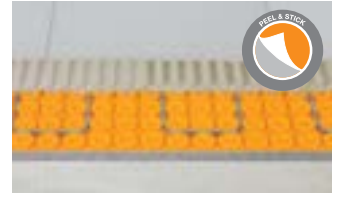

Schluter®-DITRA-HEAT-DUO-PS
Page 118



Schluter®-DITRA-HEAT-E-HK
Page 119



Schluter®-DITRA-HEAT-E-WIFI
Page 122



Schluter®-DITRA-HEAT-E-RT
Page 122



Schluter®-DITRA-HEAT-E-R
Page 122



Schluter®-DITRA-HEAT-E-RR
Page 122



Schluter®-DITRA-HEAT-E-RS1
Page 123



Schluter®-DITRA-HEAT-E-RRS
Page 123

SHOWER SYSTEM



Schluter®-KERDI/-DS
Page 125



Schluter®-KERDI-BAND
Page 126

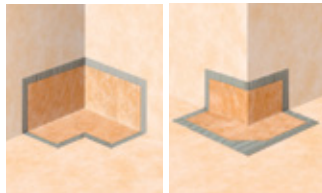

Schluter®-KERDI-KERECK-F
Page 126



Schluter®-KERDI-KERS-B
Page 127



Schluter®-KERDI-KERS
Page 127

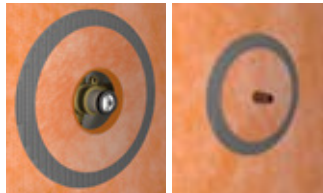

Schluter®-KERDI-SEAL-PS/-MV
Page 128



Schluter®-KERDI-KM
Page 128



Schluter®-KERDI-DRAIN
Page 130 - 140



Schluter®-KERDI-SHOWER-CB
Page 137

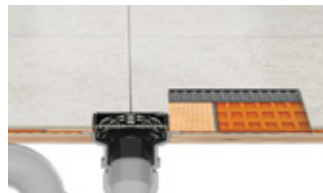

Schluter®-KERDI-DRAIN-F
Page 141

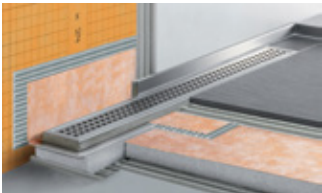

Schluter®-KERDI-LINE
Page 144 - 149



Schluter®-KERDI-LINE-FC
Page 149



Schluter®-KERDI-LINE-VARIO
Page 150 - 151



Schluter®-KERDI-SHOWER-T/-TS/-TT
Page 153

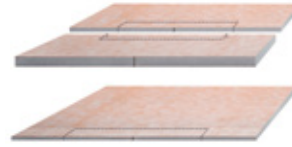

Schluter®-KERDI-SHOWER-LT/-LTS
Page 154



Schluter®-KERDI-SHOWER-R
Page 155



Schluter®-KERDI-BOARD-SC
Page 155



Schluter®-KERDI-BOARD-SB
Page 156



Schluter®-KERDI-BOARD-SN
Page 156



Schluter®-KERDI-BOARD-SNLT
Page 158



Schluter®-LIPROTEC-ECX
Page 159



Schluter®-LIPROTEC-ECD
Page 159



Schluter®-LIPROTEC-CW
Page 159



Schluter®-KERDI-SHOWER-KIT
Page 160 - 162



Schluter®-KERDI-TUBKIT
Page 163



Schluter®-KERDI-BOARD-KIT
Page 164



Schluter®-SHELF
Page 166 - 175



Schluter®-SHOWERPROFILE-S
Page 176



Schluter®-SHOWERPROFILE-R
Page 176



Schluter®-SHOWERPROFILE-WS
Page 177



Schluter®-SHOWERPROFILE-WSK
Page 177



Schluter®-DECO-SG
Page 178



Schluter®-DECO-SGC
Page 179



Schluter®-KERDI-FIX
Page 179

MODULAR SCREED SYSTEM FOR CONVENTIONAL & RADIANT-HEATED SCREEDS

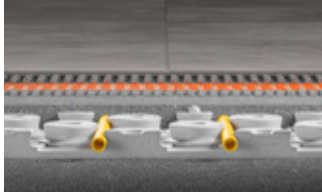

Schluter®-**BEKOTEC**
Page 181



Schluter®-**BEKOTEC-F**
Page 181



Schluter®-**BEKOTEC-BRS**
Page 182



Schluter®-**BEKOTEC-BRSK**
Page 182



Schluter®-**BEKOTEC-BRS/KF**
Page 182



Schluter®-**BEKOTEC-BRS/KSF**
Page 182

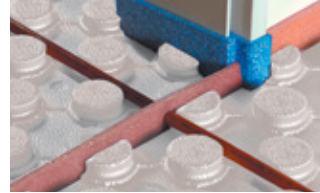

Schluter®-**DILEX-DFP**
Page 182



Schluter®-**BEKOTEC-THERM-RH-75**
Page 182

SETTING MATERIALS



Schluter®-**SET**
Page 184



Schluter®-**ALL-SET**
Page 184



Schluter®-**FAST-SET**
Page 184



Schluter®-**PRIMER-U**
Page 186

TOOLS

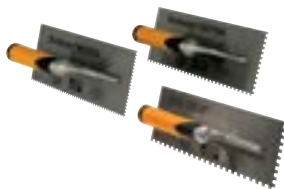

Schluter®-**DITRA-TROWEL**
Schluter®-**KERDI-TROWEL**
Schluter®-**DITRA-HEAT/**
-DITRA-XL-TROWEL
Page 187



Schluter®-**DITRA Roller**
Page 187



Schluter®-**SNIPS**
Page 188



Schluter®-**PROCUT-TSM**
Page 188

MANUFACTURING

The majority of Schluter® products sold in North America are also produced here.
In addition, products produced in North America are shipped overseas for worldwide distribution.
International cooperation in product development and support of the local economies are vital elements of our core strategy.



Schluter® Profiles

Transition & edge-protection profiles for floors

Transitions from a tiled floor to other surfaces need to be protected, and floor profiles are designed to ensure a smooth transition, while preventing tile edges from chipping and cracking. Schluter Systems offers a vast selection of floor profiles that protect tile edges between floor coverings at both equal and lower elevations.

Schluter floor profiles improve the integrity of the tile assembly, are maintenance-free, and are available in a variety of shapes, sizes, materials, and finishes to complement the design of any room.





Schluter®-SCHIENE

Schluter®-SCHIENE features an 87° angle to transfer point loads and protect tile edges in tile coverings. Typical applications include edge protection where tile is bordered by carpet, at expansion joints, or as a decorative edging for stairs. SCHIENE in aluminum and brass, in sizes 1/4" (6 mm) and higher, features an integrated joint spacer that establishes a defined joint cavity between the tile and the profile.

Note: Also available in stainless steel 316L (1.4404 = V4A). Contact Customer Service for pricing and availability.

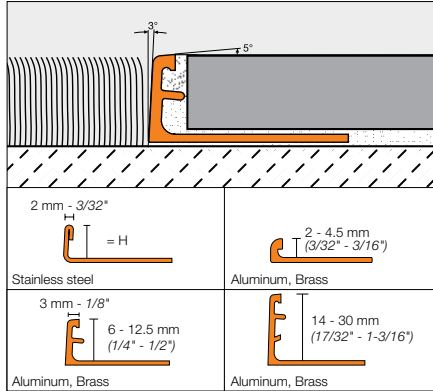

Schluter®-SCHIENE										
Length = 2.5 m - 8' 2-1/2"	Stainless steel 304 (1.4301 = V2A) (E)		Brushed stainless steel 304 (1.4301 = V2A) (EB)		Solid brass (M)*		Aluminum (A)		Satin anodized aluminum (AE)	
H = mm - in.	Item No.	\$ / Length	Item No.	\$ / Length	Item No.	\$ / Length	Item No.	\$ / Length	Item No.	\$ / Length
2 - 3/32	E 20	27.43	-	-	-	-	A 20	9.09	AE 20	13.90
3 - 1/8	E 30	30.17	-	-	M 30	28.80	A 30	9.53	AE 30	14.55
4.5 - 3/16	E 45	35.68	-	-	M 45	32.25	A 45	9.75	AE 45	14.91
6 - 1/4	E 60	36.37	E 60 EB	43.64	M 60	33.61	A 60	10.42	AE 60	15.56
7 - 9/32	E 70	37.06	-	-	-	-	A 70	10.60	AE 70	15.87
8 - 5/16	E 80	36.62	E 80 EB	45.29	M 80	37.03	A 80	10.47	AE 80	15.45
9 - 11/32	E 90	38.94	-	-	M 90	37.45	A 90	11.14	AE 90	16.75
10 - 3/8	E 100	38.64	E 100 EB	47.75	M 100	37.86	A 100	11.01	AE 100	16.39
11 - 7/16	E 110	39.23	E 110 EB	49.36	M 110	38.84	A 110	11.38	AE 110	17.46
12.5 - 1/2	E 125	39.95	E 125 EB	49.40	M 125	39.25	A 125	11.58	AE 125	17.57
14 - 17/32	E 140	42.86	-	-	-	-	A 140	13.68	AE 140	19.59
15 - 9/16	E 150	48.02	-	-	M 150	44.05	A 150	14.32	AE 150	19.81
16 - 5/8	E 160	48.99	-	-	M 160	44.33	A 160	14.73	AE 160	21.48
17.5 - 11/16	E 175	49.41	-	-	M 175	45.14	A 175	15.64	AE 175	22.73
20 - 3/4	E 200	51.45	-	-	M 200	46.11	A 200	16.29	AE 200	24.64
21 - 13/16	-	-	-	-	-	-	A 210	16.93	AE 210	25.28
22.5 - 7/8	E 225	53.53	-	-	M 225	56.26	A 225	17.34	AE 225	25.92
25 - 1	E 250	55.57	-	-	M 250	57.36	A 250	18.21	AE 250	27.17
27.5 - 1-1/16	-	-	-	-	-	-	A 275	18.89	AE 275	29.06
30 - 1-3/16	E 300	59.71	-	-	M 300	62.42	A 300	20.19	AE 300	30.31

10-foot (3.05 m) SCHIENE Profiles – Stainless Steel		
Length = 3.05 m - 10'	Stainless steel 304 (1.4301 = V2A) (E)	
H = mm - in.	Profile	\$ / Length
8 - 5/16	E 80 / 300	45.77
10 - 3/8	E 100 / 300	48.30
12.5 - 1/2	E 125 / 300	49.95

Special shipping conditions apply, see pages 199 - 200.

Note: The anchoring leg of Schluter®-SCHIENE is available with a special radius perforation so that the profile can be used to form curves.

- Price surcharge: \$0.70 per foot
- Available in all materials
- Item No.: R / Profile No. (e.g., R/M 80)
- For delivery time, please call Customer Service



* ⚠ **WARNING:** Reproductive Harm - www.P65Warnings.ca.gov



Schluter®-SCHIENE								
Length = 2.5 m - 8' 2-1/2"	Polished chrome anodized aluminum (ACG)		Brushed chrome anodized aluminum (ACGB)		Satin nickel anodized aluminum (AT)		Polished nickel anodized aluminum (ATG)	
H = mm - in.	Item No.	\$ / Length	Item No.	\$ / Length	Item No.	\$ / Length	Item No.	\$ / Length
6 - 1/4	A 60 ACG	18.18	A 60 ACGB	19.43	A 60 AT	18.49	A 60 ATG	23.93
8 - 5/16	A 80 ACG	19.43	A 80 ACGB	19.96	A 80 AT	18.88	A 80 ATG	24.30
10 - 3/8	A 100 ACG	21.50	A 100 ACGB	22.08	A 100 AT	19.24	A 100 ATG	24.95
12.5 - 1/2	A 125 ACG	22.74	A 125 ACGB	23.31	A 125 AT	19.88	A 125 ATG	25.16

Length = 2.5 m - 8' 2-1/2"	Brushed nickel anodized aluminum (ATGB)		Satin copper anodized aluminum (AK)		Polished copper anodized aluminum (AKG)		Brushed copper anodized aluminum (AKGB)	
H = mm - in.	Item No.	\$ / Length	Item No.	\$ / Length	Item No.	\$ / Length	Item No.	\$ / Length
6 - 1/4	A 60 ATGB	21.48	A 60 AK	18.49	A 60 AKG	23.93	A 60 AKGB	21.48
8 - 5/16	A 80 ATGB	21.73	A 80 AK	19.24	A 80 AKG	24.30	A 80 AKGB	22.16
10 - 3/8	A 100 ATGB	22.19	A 100 AK	19.62	A 100 AKG	24.95	A 100 AKGB	22.62
12.5 - 1/2	A 125 ATGB	23.16	A 125 AK	20.26	A 125 AKG	25.16	A 125 AKGB	23.16

Length = 2.5 m - 8' 2-1/2"	Satin brass anodized aluminum (AM)		Polished brass anodized aluminum (AMG)		Brushed brass anodized aluminum (AMGB)		Brushed antique bronze anodized aluminum (ABGB)	
H = mm - in.	Item No.	\$ / Length	Item No.	\$ / Length	Item No.	\$ / Length	Item No.	\$ / Length
6 - 1/4	A 60 AM	15.51	A 60 AMG	18.18	A 60 AMGB	20.67	A 60 ABGB	22.95
8 - 5/16	A 80 AM	16.12	A 80 AMG	19.43	A 80 AMGB	21.38	A 80 ABGB	24.14
10 - 3/8	A 100 AM	17.98	A 100 AMG	21.91	A 100 AMGB	22.94	A 100 ABGB	24.87
12.5 - 1/2	A 125 AM	19.21	A 125 AMG	23.18	A 125 AMGB	24.16	A 125 ABGB	26.94

10-foot (3.05 m) SCHIENE Profiles – Anodized Aluminum								
Length = 3.05 m - 10'	Satin anodized aluminum (AE)		Polished chrome anodized aluminum (ACG)		Satin nickel anodized aluminum (AT)		Brushed antique bronze anodized aluminum (ABGB)	
H = mm - in.	Item No.	\$ / Length	Item No.	\$ / Length	Item No.	\$ / Length	Item No.	\$ / Length
8 - 5/16	AE 80 / 300	19.32	A 80 ACG / 300	24.29	A 80 AT / 300	23.61	A 80 ABGB / 300	30.18
10 - 3/8	AE 100 / 300	20.49	A 100 ACG / 300	26.86	A 100 AT / 300	24.06	A 100 ABGB / 300	31.10
12.5 - 1/2	AE 125 / 300	21.97	A 125 ACG / 300	28.41	A 125 AT / 300	24.85	A 125 ABGB / 300	33.67

Special shipping conditions apply, see pages 199 - 200.



Schluter®-TRENDLINE Textured Color-coated Aluminum

Matte White and Matte Black

Schluter®-SCHIENE			
Length = 2.5 m - 8' 2-1/2"		Textured color-coated aluminum (TS)	
H = mm - in.	Item No.	\$ / Length	
6 - 1/4	A 60 + color*	32.72	
8 - 5/16	A 80 + color*	33.45	
10 - 3/8	A 100 + color*	34.10	
11 - 7/16	A 110 + color*	34.45	
12.5 - 1/2	A 125 + color*	35.13	

Schluter®-SCHIENE			
Length = 2.5 m - 8' 2-1/2"		Textured color-coated aluminum	
H = mm - in.	Item No.	\$ / Length	
3 - 1/8	A 30 + color*	25.15	
4.5 - 3/16	A 45 + color*	25.65	
6 - 1/4	A 60 + color*	26.18	
8 - 5/16	A 80 + color*	26.75	
10 - 3/8	A 100 + color*	27.27	
11 - 7/16	A 110 + color*	27.56	
12.5 - 1/2	A 125 + color*	28.11	

***Color Codes**

* To complete the item number, add the **color** code (e.g., A 60 **TSC**).

***Color Codes**

* To complete the item number, add the **color** code (e.g., A 60 **MGS**).

Note: The anchoring leg of **Schluter®-SCHIENE** is available with a special radius perforation so that the profile can be used to form curves.



- Price surcharge: \$0.70 per foot
- Available in all materials
- Polished and color-coated aluminum finishes require a relatively large bending radius
- Item No.: R / Profile No. (e.g., R/A 80 AT)
- For delivery time, please call Customer Service

i SCHIENE in textured color-coated aluminum finishes is suitable for floor installations within residential applications only.

Schluter®-SCHIENE-RADIUS

Schluter®-SCHIENE-RADIUS is an extruded profile, with special perforations, for finishing and protecting the edges of curved tile coverings. SCHIENE-RADIUS provides edge protection while enhancing the aesthetic appearance of a curved design, including curved tile-to-tile transitions and curved outside wall corners, as well as curved designs in other surface coverings. Other sizes are available upon request.

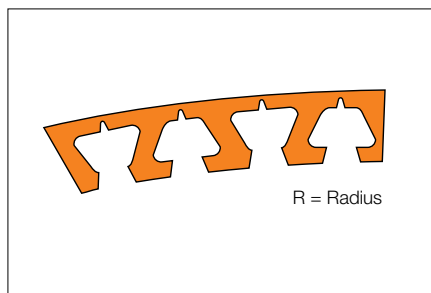

Schluter®-SCHIENE-RADIUS									
Length = 2.5 m - 8' 2-1/2"		Stainless steel 304 (1.4301 = V2A) (E)		Solid brass (M)*		Aluminum (A)		Satin anodized aluminum (AE)	
H = mm - in.	Item No.	\$ / Length	Item No.	\$ / Length	Item No.	\$ / Length	Item No.	\$ / Length	
6 - 1/4	R/E 60	41.97	R/M 60	39.21	R/A 60	16.02	R/AE 60	21.16	
8 - 5/16	R/E 80	42.22	R/M 80	42.63	R/A 80	16.07	R/AE 80	21.05	
10 - 3/8	R/E 100	44.24	R/M 100	43.46	R/A 100	16.61	R/AE 100	21.99	
12.5 - 1/2	R/E 125	45.55	R/M 125	44.85	R/A 125	17.18	R/AE 125	23.17	

* **WARNING:** Reproductive Harm - www.P65Warnings.ca.gov



Schluter®-DECO

Schluter®-DECO is designed to provide decorative lines within tile coverings and edge protection at transitions from tile coverings to other same-height surface coverings such as wood or carpet. The profile features a 1/4" (6 mm)-wide visible surface.

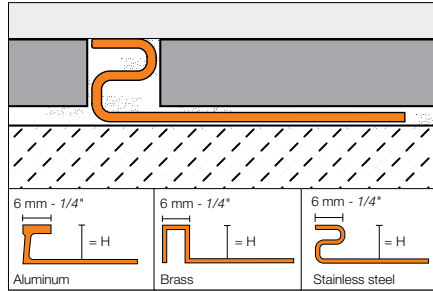

Schluter®-DECO								
Length = 2.5 m - 8' 2-1/2"	Stainless steel 304 (1.4301 = V2A) (E)		Solid brass (M)*		Chrome-plated solid brass (MC)*		Satin anodized aluminum (AE)	
H = mm - in.	Item No.	\$ / Length	Item No.	\$ / Length	Item No.	\$ / Length	Item No.	\$ / Length
8 - 5/16	E 80 D	46.33	-	-	-	-	AE 80 D	22.14
9 - 11/32	E 90 D	46.92	M 90 D	88.86	MC 90 D	193.65	-	-
10 - 3/8	E 100 D	47.63	-	-	-	-	AE 100 D	24.96
11 - 7/16	E 110 D	48.24	M 110 D	95.58	MC 110 D	200.52	-	-
12.5 - 1/2	E 125 D	49.39	M 125 D	100.20	MC 125 D	205.14	AE 125 D	25.77
14 - 17/32	E 140 D	50.14	-	-	-	-	-	-
16 - 5/8	E 160 D	51.74	-	-	-	-	-	-
18.5 - 23/32	E 185 D	53.49	-	-	-	-	-	-
21 - 13/16	E 210 D	55.11	-	-	-	-	-	-
25 - 1	E 250 D	58.17	-	-	-	-	-	-
30 - 1-3/16	E 300 D	61.37	-	-	-	-	-	-

Note: The anchoring leg of **Schluter®-DECO** is available with a special radius perforation so that the profile can be used to form curves.

- Price surcharge: \$0.70 per foot
- Available in all materials except stainless steel and chrome-plated solid brass
- Item No.: R / Profile No. (e.g., R/M 90 D)
- For delivery time, please call Customer Service



* **WARNING:** Reproductive Harm - www.P65Warnings.ca.gov



Schluter®-RENO-T

Schluter®-RENO-T is designed to provide transitions between existing, same-height, hard surface floor coverings, primarily in retrofit applications (e.g., ceramic tile or natural stone, parquet flooring, concrete pavers, laminate, etc.). RENO-T, in brass and anodized aluminum size 9/14, is flexible in the lateral direction and can be used in curved applications.

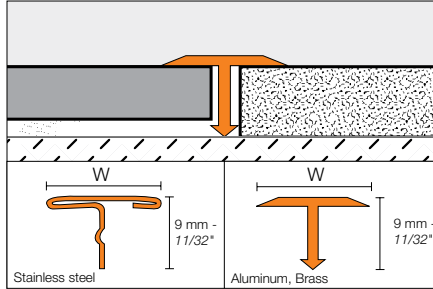

Schluter®-RENO-T

Length = 2.5 m - 8' 2-1/2"	Stainless steel 304 (1.4301 = V2A) (E)		Brushed stainless steel 304 (1.4301 = V2A) (EB)		Solid brass (M)*		Satin anodized aluminum (AE)	
W = mm - in.	Item No.	\$ / Length	Item No.	\$ / Length	Item No.	\$ / Length	Item No.	\$ / Length
14 - 17/32	T 9/14 E	35.12	T 9/14 EB	37.37	T 9/14 M	23.94	T 9/14 AE	12.43
25 - 1	T 9/25 E	48.03	T 9/25 EB	52.48	T 9/25 M	40.58	T 9/25 AE	20.09

Length = 2.5 m - 8' 2-1/2"	Satin nickel anodized aluminum (AT)		Satin copper anodized aluminum (AK)		Satin brass anodized aluminum (AM)	
W = mm - in.	Item No.	\$ / Length	Item No.	\$ / Length	Item No.	\$ / Length
14 - 17/32	T 9/14 AT	14.54	T 9/14 AK	14.84	T 9/14 AM	13.44
25 - 1	T 9/25 AT	24.19	T 9/25 AK	24.19	T 9/25 AM	20.45

* **WARNING:** Reproductive Harm - www.P65Warnings.ca.gov



Schluter®-RENO-TK

Schluter®-RENO-TK is designed to protect tile edges and provide a smooth transition from tile coverings to floor coverings at lower elevations, typically carpet. The 1/4" (6 mm) channel beneath the sloped flange of the profile hides and protects the cut edge of lower adjoining surface coverings. RENO-TK in anodized aluminum sizes 5/16" (8 mm) and larger features an integrated joint spacer that establishes a defined joint cavity between the tile and the profile.

ADA-Compliant

Technical Note: ADA requirements regarding transitions between surfaces of different heights:

- Up to 6 mm (1/4") - no special requirements
- 6 mm (1/4") to 12.5 mm (1/2") - slope ratio, 1:2
- More than 12.5 mm (1/2") - slope ratio, 1:12

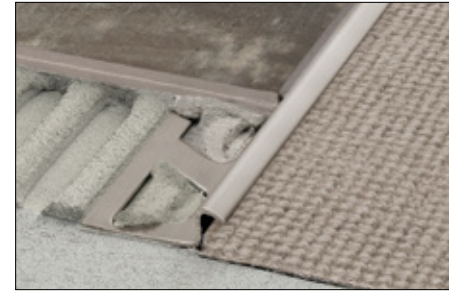
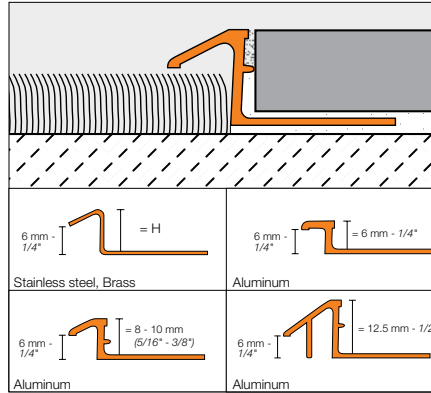
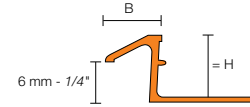

Diagram Values



H = mm - in.	B = mm - in.	
	Aluminum	Stainless steel/Brass
6 - 1/4	7.5 - 19/64	-
8 - 5/16	8.5 - 21/64	7 - 9/32
10 - 3/8	8.5 - 21/64	11 - 7/16
11 - 7/16	-	13.5 - 17/32
12.5 - 1/2	15.5 - 39/64	16.5 - 21/32

Schluter®-RENO-TK

Length = 2.5 m - 8' 2-1/2"	Stainless steel 304 (1.4301 = V2A) (E)		Brushed stainless steel 304 (1.4301 = V2A) (EB)		Solid brass (M)*		Satin anodized aluminum (AE)	
	H = mm - in.	Item No.	\$ / Length	Item No.	\$ / Length	Item No.	\$ / Length	Item No.
6 - 1/4	-	-	-	-	-	-	AETK 60	18.71
8 - 5/16	ETK 80	52.17	EBTK 80	67.84	MTK 80	43.28	AETK 80	20.09
10 - 3/8	ETK 100	57.04	EBTK 100	74.16	MTK 100	46.93	AETK 100	21.47
11 - 7/16	ETK 110	61.66	EBTK 110	76.36	-	-	-	-
12.5 - 1/2	ETK 125	63.32	EBTK 125	79.14	MTK 125	63.57	AETK 125	27.68

Length = 2.5 m - 8' 2-1/2"	Bright chrome anod. alu. (ACB)		Satin nickel anod. alu. (AT)		Brushed nickel anod. alu. (ATGB)		Brushed antique bronze anod. alu. (ABGB)	
	H = mm - in.	Item No.	\$ / Length	Item No.	\$ / Length	Item No.	\$ / Length	Item No.
6 - 1/4	ATK 60 ACB	20.09	ATK 60 AT	21.47	-	-	-	-
8 - 5/16	ATK 80 ACB	21.47	ATK 80 AT	22.87	ATK 80 ATGB	29.50	ATK 80 ABGB	29.50
10 - 3/8	ATK 100 ACB	22.87	ATK 100 AT	27.68	ATK 100 ATGB	31.97	ATK 100 ABGB	31.97
12.5 - 1/2	ATK 125 ACB	29.78	ATK 125 AT	31.17	ATK 125 ATGB	38.81	ATK 125 ABGB	38.81

Note: The anchoring leg of **Schluter®-RENO-TK** is available with a special radius perforation so that the profile can be used to form curves.

- Price surcharge: \$0.70 per foot
- Available in all materials except stainless steel
- Bright/polished finishes require a relatively large bending radius
- Item No.: R / Profile No. (e.g., R/ATK 100 ACB)
- For delivery time, please call Customer Service



* **WARNING:** Reproductive Harm - www.P65Warnings.ca.gov



Schluter®-RENO-V

Schluter®-RENO-V is designed to protect tile edges and provide a smooth transition between tile coverings and floor coverings at lower elevations. The profile features a movable transition arm that allows the profile to adjust to the height of the adjacent floor covering via a ball-and-socket joint and eliminates trip hazards. RENO-V features an integrated joint spacer that establishes a defined joint cavity between the tile and the profile.

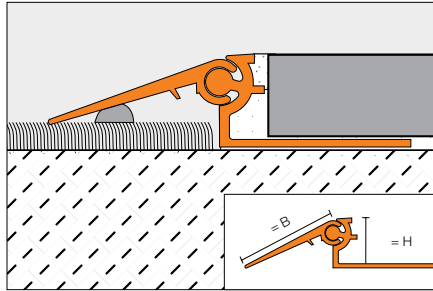

B = 20 mm - 3/4", 30 mm - 1-3/16", 40 mm - 1-9/16"

Schluter®-RENO-V			
Length = 2.5 m - 8' 2-1/2"	Satin anodized aluminum (AE)		
H = mm - in.	Item No.	\$/ Length	
B = 20 mm - 3/4"			
8 - 5/16	AEVT 80 B20	57.23	
10 - 3/8	AEVT 100 B20	58.64	
12.5 - 1/2	AEVT 125 B20	60.05	
15 - 9/16	AEVT 150 B20	62.14	
17.5 - 11/16	AEVT 175 B20	63.56	
20 - 3/4	AEVT 200 B20	68.53	
B = 30 mm - 1-3/16"			
8 - 5/16	AEVT 80 B30	63.56	
10 - 3/8	AEVT 100 B30	64.95	
12.5 - 1/2	AEVT 125 B30	65.70	
15 - 9/16	AEVT 150 B30	67.13	
17.5 - 11/16	AEVT 175 B30	68.53	
20 - 3/4	AEVT 200 B30	73.46	
B = 40 mm - 1-9/16"			
8 - 5/16	AEVT 80 B40	69.93	
10 - 3/8	AEVT 100 B40	71.35	
12.5 - 1/2	AEVT 125 B40	73.17	
15 - 9/16	AEVT 150 B40	74.87	
17.5 - 11/16	AEVT 175 B40	76.30	
20 - 3/4	AEVT 200 B40	81.24	

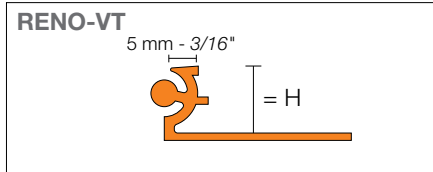

Schluter®-RENO-VT			
Support profile			
Length = 2.5 m - 8' 2-1/2"	Satin anodized aluminum (AE)		
H = mm - in.	Item No.	\$/ Length	
8 - 5/16	AEVT 80	26.35	
10 - 3/8	AEVT 100	27.55	
12.5 - 1/2	AEVT 125	29.00	
15 - 9/16	AEVT 150	30.55	
17.5 - 11/16	AEVT 175	32.01	
20 - 3/4	AEVT 200	36.20	

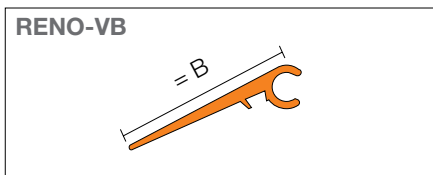

Schluter®-RENO-VB			
Variable transition arm			
Length = 2.5 m - 8' 2-1/2"	Satin anodized aluminum (AE)		
B = mm - in.	Item No.	\$/ Length	
20 - 3/4	AEVB 20	25.58	
30 - 1-3/16	AEVB 30	29.50	
40 - 1-9/16	AEVB 40	36.73	



Schluter®-RENO-RAMP/-K

Schluter®-RENO-RAMP/-K are designed to protect tile edges and provide a smooth transition between tile coverings and floor coverings at lower elevations or finished concrete. The sloped surface eliminates trip hazards and allows easy access for wheel carts. RENO-RAMP/-K feature an integrated joint spacer that establishes a defined joint cavity between the tile and the profile.

RENO-RAMP has an anchoring leg which is embedded in the tile bond coat.

RENO-RAMP-K is subsequently bonded adjacent to existing floor coverings.

ADA-Compliant

Note: 15 mm (9/16") and 20 mm (3/4") are not ADA-compliant.

Technical Note: ADA requirements regarding transitions between surfaces of different heights:

- Up to 6 mm (1/4") - no special requirements
- 6 mm (1/4") to 12.5 mm (1/2") - slope ratio, 1:2
- More than 12.5 mm (1/2") - slope ratio, 1:12

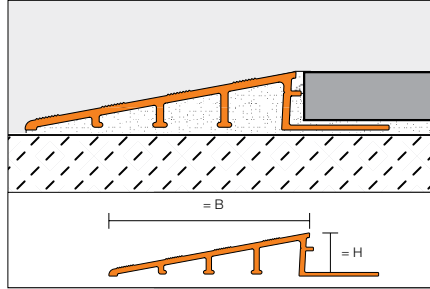

B= 50 mm - 2", 64 mm - 2-1/2", 89 mm - 3-1/2"



Diagram Values

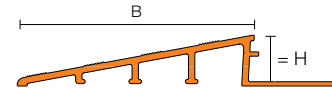

H = mm - in.	B = mm - in.
6 - 1/4	50 - 2
10 - 3/8	64 - 2-1/2
12.5 - 1/2	64 - 2-1/2
12.5 - 1/2	89 - 3-1/2
15 - 9/16	89 - 3-1/2
20 - 3/4	89 - 3-1/2

Schluter®-RENO-RAMP

Length = 2.5 m - 8' 2-1/2"	Satin anodized aluminum (AE)	
H = mm - in.	Item No.	\$/ Length
B = 50 mm - 2"		
6 - 1/4	AERP 60 B50	49.59
B = 64 mm - 2-1/2"		
10 - 3/8	AERP 100 B65	49.93
12.5 - 1/2	AERP 125 B65	52.07
B = 89 mm - 3-1/2"		
12.5 - 1/2	AERP 125 B90	67.06
15 - 9/16	AERP 150 B90	69.21
20 - 3/4	AERP 200 B90	72.74

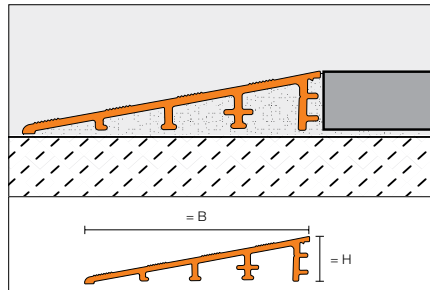

B= 64 mm - 2-1/2"

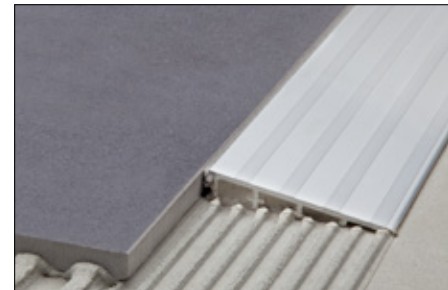

Schluter®-RENO-RAMP-K

Length = 2.5 m - 8' 2-1/2"	Satin anodized aluminum (AE)	
H = mm - in.	Item No.	\$/ Length
B = 64 mm - 2-1/2"		
12.5 - 1/2	AERPK 125 B65	60.85



Schluter®-RENO-U

Schluter®-RENO-U is designed to protect tile edges and provide a smooth transition between tile coverings and floor coverings at lower elevations or finished concrete. The sloped surface eliminates trip hazards and the leading edge of the profile abuts the lower surface covering. RENO-U in anodized aluminum features an integrated joint spacer that establishes a defined joint cavity between the tile and the profile.

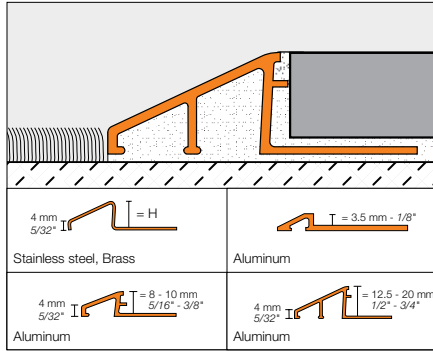

ADA-Compliant

Note: When leading edge abuts lower surface covering, sizes 20 mm (3/4") and 17.5 mm (11/16") are not ADA-compliant. When leading edge rests on top of lower surface covering, sizes 20 mm (3/4"), 15 mm (9/16"), and 17.5 mm (11/16") are not ADA-compliant.

Technical Note: ADA requirements regarding transitions between surfaces of different heights:

- Up to 6 mm (1/4") - no special requirements
- 6 mm (1/4") to 12.5 mm (1/2") - slope ratio, 1:2
- More than 12.5 mm (1/2") - slope ratio, 1:12

Diagram Values

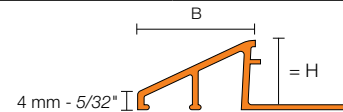

H = mm - in.	B = mm - in.	
	Aluminum	Stainless steel/Brass
3.5 - 1/8	9 - 23/64	-
8 - 5/16	12.5 - 31/64	13 - 33/64
10 - 3/8	16.5 - 21/32	17.5 - 11/16
11 - 7/16	-	19.5 - 49/64
12.5 - 1/2	22 - 55/64	23 - 29/32
15 - 9/16	27.5 - 1-5/64	28 - 1-7/64
17.5 - 11/16	27 - 1-1/16	33.5 - 1-5/16
20 - 3/4	-	40 - 1-37/64

Schluter®-RENO-U								
Length = 2.5 m - 8' 2-1/2"	Stainless steel 304 (1.4301 = V2A) (E)		Brushed stainless steel 304 (1.4301 = V2A) (EB)		Solid brass (M)*		Satin anodized aluminum (AE)	
H = mm - in.	Item No.	\$ / Length	Item No.	\$ / Length	Item No.	\$ / Length	Item No.	\$ / Length
3.5 - 1/8	-	-	-	-	-	-	AEU 35	16.07
8 - 5/16	EU 80	53.75	EBU 80	82.99	MU 80	57.89	AEU 80	19.37
10 - 3/8	EU 100	58.77	EBU 100	88.17	MU 100	65.02	AEU 100	20.37
11 - 7/16	EU 110	63.67	EBU 110	91.16	-	-	-	-
12.5 - 1/2	EU 125	65.21	EBU 125	94.88	MU 125	81.58	AEU 125	27.03
15 - 9/16	EU 150	70.96	EBU 150	100.49	MU 150	90.48	AEU 150	34.62
17.5 - 11/16	EU 175	78.03	EBU 175	107.49	-	-	AEU 175	42.11
20 - 3/4	EU 200	85.87	EBU 200	115.03	-	-	-	-

Length = 2.5 m - 8' 2-1/2"	Bright chrome anod. alu. (ACB)		Satin nickel anod. alu. (AT)		Brushed nickel anod. alu. (ATGB)	
H = mm - in.	Item No.	\$ / Length	Item No.	\$ / Length	Item No.	\$ / Length
8 - 5/16	AU 80 ACB	21.19	AU 80 AT	20.84	AU 80 ATGB	34.37
10 - 3/8	AU 100 ACB	24.72	AU 100 AT	21.90	AU 100 ATGB	37.75
12.5 - 1/2	AU 125 ACB	31.79	AU 125 AT	28.24	AU 125 ATGB	45.56

Length = 2.5 m - 8' 2-1/2"	Brushed antique bronze anod. alu. (ABGB)		Satin brass anod. alu. (AM)	
H = mm - in.	Item No.	\$ / Length	Item No.	\$ / Length
8 - 5/16	AU 80 ABGB	34.37	AU 80 AM	20.84
10 - 3/8	AU 100 ABGB	37.75	AU 100 AM	21.90
12.5 - 1/2	AU 125 ABGB	45.56	AU 125 AM	28.24

* **WARNING:** Reproductive Harm - www.P65Warnings.ca.gov



Schluter® Profiles

Finishing & edge-protection profiles for walls & countertops

From framing a shower niche to accentuating a fireplace surround, Schluter profiles add the perfect finishing touch to tiled walls as they conceal and protect exposed tile edges and eliminate the need for unsightly caulking. The assortment of available accessories eliminate the need for mitering, expedite installation time, and provide a nice, clean finish.

Resistant to staining, scratching, and high heat, tiled countertops require no maintenance and are easy to clean with standard household products. Cover the subassembly using a profile with a wide reveal, or frame a designated area for bonding accent tile. Do-away with caulking around the sink and bring the elegance of your tile installation to the next level.



Backsplash trim: Schluter®-QUADEC in bright white (page 40)
Counter trim: Schluter®-RONDEC-STEP in brushed chrome (page 49)



Schluter®-JOLLY

Schluter®-JOLLY is a decorative profile featuring a 90° angle designed to finish and protect external corners and other tile edges in wall applications. Its 90° angle creates a clean, flush look on wall corner installations, and the joint spacers on both sides of the profile ensure consistent grout joints and perfect symmetry. Matching corners are available, which feature innovative plug-in connections that result in clean, visually appealing corner applications.

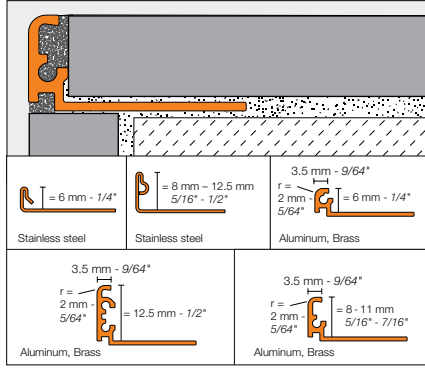

Stainless Steel

Schluter®-JOLLY				
Length = 2.5 m - 8' 2-1/2"	Brushed stainless steel 304 (1.4301 = V2A) (EB)			
H = mm - in.	Profile	\$ / Length	Outside corner	\$ / Unit
6 - 1/4	J 60 EB	43.64	EV / J 60 EB	21.50
8 - 5/16	J 80 EB	45.29	EV / J 80 EB	21.50
10 - 3/8	J 100 EB	47.75	EV / J 100 EB	21.50
11 - 7/16	J 110 EB	49.36	EV / J 110 EB	21.50
12.5 - 1/2	J 125 EB	49.40	EV / J 125 EB	21.50

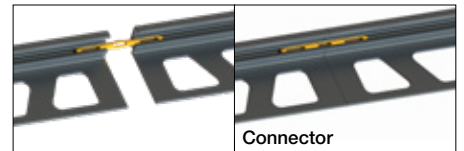
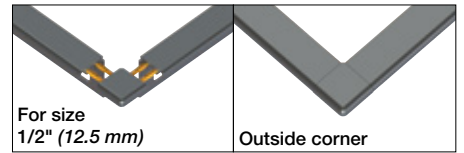
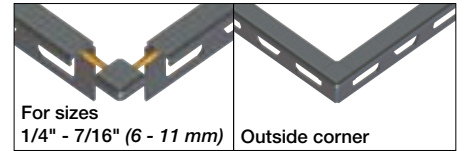

Brass

Schluter®-JOLLY				
Length = 2.5 m - 8' 2-1/2"	Chrome-plated solid brass (MC) *			
H = mm - in.	Profile	\$ / Length	Outside corner	\$ / Unit
6 - 1/4	J 60 MC	86.32	EV / J 60 MC	20.57
8 - 5/16	J 80 MC	89.33	EV / J 80 MC	20.57
10 - 3/8	J 100 MC	90.49	EV / J 100 MC	20.57
11 - 7/16	J 110 MC	91.39	EV / J 110 MC	20.57
12.5 - 1/2	J 125 MC	92.00	EV / J 125 MC	20.57

Notes:

- Corners in sizes 6 to 11 mm (1/4" to 7/16") include 4 plug-in connectors.
- Corners in size 12.5 mm (1/2") include 8 plug-in connectors.

Connector	Quantity	\$ / Pkg.
V / J PP4	4	2.72



Note: The anchoring leg of **Schluter®-JOLLY** is available with a special radius perforation so that the profile can be used to form curves.

- Price surcharge: \$0.70 per foot
- Chrome-plated brass requires a relatively large bending radius
- Item No.: R / Profile No. (e.g., R/J 60 EB)
- For delivery time, please call Customer Service



* **WARNING:** Reproductive Harm - www.P65Warnings.ca.gov



Anodized Aluminum

Schluter®-JOLLY								
Length = 2.5 m - 8' 2-1/2"	Satin anodized aluminum (AE)				Polished chrome anodized aluminum (ACG)			
H = mm - in.	Profile	\$/ Length	Outside corner	\$/ Unit	Profile	\$/ Length	Outside corner	\$/ Unit
6 - 1/4	J 60 AE	15.56	EV / J 60 AE	8.20	J 60 ACG	18.18	EV / J 60 ACG	10.73
8 - 5/16	J 80 AE	15.45	EV / J 80 AE	8.20	J 80 ACG	19.43	EV / J 80 ACG	10.73
10 - 3/8	J 100 AE	16.39	EV / J 100 AE	8.20	J 100 ACG	21.50	EV / J 100 ACG	10.73
11 - 7/16	J 110 AE	17.46	EV / J 110 AE	8.20	J 110 ACG	21.71	EV / J 110 ACG	10.73
12.5 - 1/2	J 125 AE	17.57	EV / J 125 AE	8.20	J 125 ACG	22.74	EV / J 125 ACG	10.73

Length = 2.5 m - 8' 2-1/2"	Brushed chrome anodized aluminum (ACGB)				Satin nickel anodized aluminum (AT)			
H = mm - in.	Profile	\$/ Length	Outside corner	\$/ Unit	Profile	\$/ Length	Outside corner	\$/ Unit
6 - 1/4	J 60 ACGB	19.43	EV / J 60 ACGB	10.73	J 60 AT	18.49	EV / J 60 AT	10.73
8 - 5/16	J 80 ACGB	19.96	EV / J 80 ACGB	10.73	J 80 AT	18.88	EV / J 80 AT	10.73
10 - 3/8	J 100 ACGB	22.08	EV / J 100 ACGB	10.73	J 100 AT	19.24	EV / J 100 AT	10.73
11 - 7/16	J 110 ACGB	22.52	EV / J 110 ACGB	10.73	J 110 AT	19.43	EV / J 110 AT	10.73
12.5 - 1/2	J 125 ACGB	23.31	EV / J 125 ACGB	10.73	J 125 AT	19.88	EV / J 125 AT	10.73

Length = 2.5 m - 8' 2-1/2"	Polished nickel anodized aluminum (ATG)				Brushed nickel anodized aluminum (ATGB)			
H = mm - in.	Profile	\$/ Length	Outside corner	\$/ Unit	Profile	\$/ Length	Outside corner	\$/ Unit
6 - 1/4	J 60 ATG	23.93	EV / J 60 ATG	10.73	J 60 ATGB	21.48	EV / J 60 ATGB	10.73
8 - 5/16	J 80 ATG	24.30	EV / J 80 ATG	10.73	J 80 ATGB	21.73	EV / J 80 ATGB	10.73
10 - 3/8	J 100 ATG	24.95	EV / J 100 ATG	10.73	J 100 ATGB	22.19	EV / J 100 ATGB	10.73
11 - 7/16	J 110 ATG	25.07	EV / J 110 ATG	10.73	J 110 ATGB	22.41	EV / J 110 ATGB	10.73
12.5 - 1/2	J 125 ATG	25.16	EV / J 125 ATG	10.73	J 125 ATGB	23.16	EV / J 125 ATGB	10.73

Length = 2.5 m - 8' 2-1/2"	Satin copper anodized aluminum (AK)				Polished copper anodized aluminum (AKG)			
H = mm - in.	Profile	\$/ Length	Outside corner	\$/ Unit	Profile	\$/ Length	Outside corner	\$/ Unit
6 - 1/4	J 60 AK	18.49	EV / J 60 AK	10.73	J 60 AKG	23.93	EV / J 60 AKG	10.73
8 - 5/16	J 80 AK	19.24	EV / J 80 AK	10.73	J 80 AKG	24.30	EV / J 80 AKG	10.73
10 - 3/8	J 100 AK	19.62	EV / J 100 AK	10.73	J 100 AKG	24.95	EV / J 100 AKG	10.73
11 - 7/16	J 110 AK	19.82	EV / J 110 AK	10.73	J 110 AKG	25.07	EV / J 110 AKG	10.73
12.5 - 1/2	J 125 AK	20.26	EV / J 125 AK	10.73	J 125 AKG	25.16	EV / J 125 AKG	10.73

Length = 2.5 m - 8' 2-1/2"	Brushed copper anodized aluminum (AKGB)				Satin brass anodized aluminum (AM)			
H = mm - in.	Profile	\$/ Length	Outside corner	\$/ Unit	Profile	\$/ Length	Outside corner	\$/ Unit
6 - 1/4	J 60 AKGB	21.48	EV / J 60 AKGB	10.73	J 60 AM	15.51	EV / J 60 AM	10.73
8 - 5/16	J 80 AKGB	22.16	EV / J 80 AKGB	10.73	J 80 AM	16.12	EV / J 80 AM	10.73
10 - 3/8	J 100 AKGB	22.62	EV / J 100 AKGB	10.73	J 100 AM	17.98	EV / J 100 AM	10.73
11 - 7/16	J 110 AKGB	22.84	EV / J 110 AKGB	10.73	J 110 AM	18.34	EV / J 110 AM	10.73
12.5 - 1/2	J 125 AKGB	23.16	EV / J 125 AKGB	10.73	J 125 AM	19.21	EV / J 125 AM	10.73



Schluter®-JOLLY								
Length = 2.5 m - 8' 2-1/2"	Polished brass anodized aluminum (AMG)				Brushed brass anodized aluminum (AMGB)			
H = mm - in.	Profile	\$ / Length	Outside corner	\$ / Unit	Profile	\$ / Length	Outside corner	\$ / Unit
6 - 1/4	J 60 AMG	18.18	EV / J 60 AMG	10.73	J 60 AMGB	20.67	EV / J 60 AMGB	10.73
8 - 5/16	J 80 AMG	19.43	EV / J 80 AMG	10.73	J 80 AMGB	21.38	EV / J 80 AMGB	10.73
10 - 3/8	J 100 AMG	21.91	EV / J 100 AMG	10.73	J 100 AMGB	22.94	EV / J 100 AMGB	10.73
11 - 7/16	J 110 AMG	22.35	EV / J 110 AMG	10.73	J 110 AMGB	23.40	EV / J 110 AMGB	10.73
12.5 - 1/2	J 125 AMG	23.18	EV / J 125 AMG	10.73	J 125 AMGB	24.16	EV / J 125 AMGB	10.73

Length = 2.5 m - 8' 2-1/2"	Brushed antique bronze anodized aluminum (ABGB)				Bright black anodized aluminum (AGSG)			
H = mm - in.	Profile	\$ / Length	Outside corner	\$ / Unit	Profile	\$ / Length	Outside corner	\$ / Unit
6 - 1/4	J 60 ABGB	22.95	EV / J 60 ABGB	10.73	J 60 AGSG	18.51	EV / J 60 AGSG	10.73
8 - 5/16	J 80 ABGB	24.14	EV / J 80 ABGB	10.73	J 80 AGSG	18.89	EV / J 80 AGSG	10.73
10 - 3/8	J 100 ABGB	24.87	EV / J 100 ABGB	10.73	J 100 AGSG	20.27	EV / J 100 AGSG	10.73
11 - 7/16	J 110 ABGB	25.62	EV / J 110 ABGB	10.73	J 110 AGSG	20.47	EV / J 110 AGSG	10.73
12.5 - 1/2	J 125 ABGB	26.94	EV / J 125 ABGB	10.73	J 125 AGSG	20.91	EV / J 125 AGSG	10.73

Length = 2.5 m - 8' 2-1/2"	Brushed graphite anodized aluminum (AGRB)			
H = mm - in.	Profile	\$ / Length	Outside corner	\$ / Unit
6 - 1/4	J 60 AGRB	22.95	EV / J 60 AGRB	10.73
8 - 5/16	J 80 AGRB	24.14	EV / J 80 AGRB	10.73
10 - 3/8	J 100 AGRB	25.35	EV / J 100 AGRB	10.73
11 - 7/16	J 110 AGRB	25.86	EV / J 110 AGRB	10.73
12.5 - 1/2	J 125 AGRB	26.94	EV / J 125 AGRB	10.73

10-foot (3.05 m) JOLLY Profiles – Anodized Aluminum								
Length = 3.05 m - 10'	Satin anodized aluminum (AE)		Polished chrome anodized aluminum (ACG)		Satin nickel anodized aluminum (AT)		Brushed antique bronze anodized aluminum (ABGB)	
H = mm - in.	Profile	\$ / Length	Profile	\$ / Length	Profile	\$ / Length	Profile	\$ / Length
8 - 5/16	J 80 AE / 300	19.32	J 80 ACG / 300	24.29	J 80 AT / 300	23.61	J 80 ABGB / 300	30.18
10 - 3/8	J 100 AE / 300	20.49	J 100 ACG / 300	26.86	J 100 AT / 300	24.06	J 100 ABGB / 300	31.10
12.5 - 1/2	J 125 AE / 300	21.97	J 125 ACG / 300	28.41	J 125 AT / 300	24.85	J 125 ABGB / 300	33.67

Special shipping conditions apply, see pages 199 - 200.

Connector	Quantity	\$ / Pkg.
V / J PP4	4	2.72



Note: The anchoring leg of **Schluter®-JOLLY** is available with a special radius perforation so that the profile can be used to form curves.

- Price surcharge: \$0.70 per foot
- Polished aluminum finishes require a relatively large bending radius
- Item No.: R / Profile No. (e.g., R/J 60 ACGB)
- For delivery time, please call Customer Service





Schluter®-TRENDLINE Textured Color-coated Aluminum

Schluter®-JOLLY					
Length = 2.5 m - 8' 2-1/2"		Textured color-coated aluminum (TS)			
H = mm - in.	Profile	\$/ Length	Outside corner	\$/ Unit	
6 - 1/4	J 60 + color*	32.72	EV / J 60 + color*	15.47	
8 - 5/16	J 80 + color*	33.45	EV / J 80 + color*	15.47	
10 - 3/8	J 100 + color*	34.10	EV / J 100 + color*	15.47	
11 - 7/16	J 110 + color*	34.45	EV / J 110 + color*	15.47	
12.5 - 1/2	J 125 + color*	35.13	EV / J 125 + color*	15.47	

***Color Codes**

TSI Ivory	TSBG Greige	TSSG Stone grey	TSC Cream	TSB Beige	TSR Rustic brown
TSOB Bronze	TSG Pewter	TSLA Light anthracite	TSDA Dark anthracite		

* To complete the item number, add the **color** code (e.g., J 60 **TSC**).

Matte White and Matte Black

Length = 2.5 m - 8' 2-1/2"		Textured color-coated aluminum			
H = mm - in.	Profile	\$/ Length	Outside corner	\$/ Unit	
6 - 1/4	J 60 + color*	26.18	EV / J 60 + color*	13.94	
8 - 5/16	J 80 + color*	26.75	EV / J 80 + color*	13.94	
10 - 3/8	J 100 + color*	27.27	EV / J 100 + color*	13.94	
11 - 7/16	J 110 + color*	27.56	EV / J 110 + color*	13.94	
12.5 - 1/2	J 125 + color*	28.11	EV / J 125 + color*	13.94	

***Color Codes**

MBW Matte white	MGS Matte black	* To complete the item number, add the color code (e.g., J 60 MGS).
--------------------	--------------------	--

10-foot (3.05 m) JOLLY Profiles – Textured Color-coated Aluminum

Length = 3.05 m - 10'		Textured color-coated aluminum (TS)		Matte white (MBW)		Matte black (MGS)	
H = mm - in.	Profile	\$/ Length	Profile	\$/ Length	Profile	\$/ Length	
6 - 1/4	J 60 + color* / 300	39.27	J 60 MBW / 300	31.42	J 60 MGS / 300	31.42	
8 - 5/16	J 80 + color* / 300	40.15	J 80 MBW / 300	32.10	J 80 MGS / 300	32.10	
10 - 3/8	J 100 + color* / 300	40.92	J 100 MBW / 300	32.73	J 100 MGS / 300	32.73	
11 - 7/16	J 110 + color* / 300	41.34	J 110 MBW / 300	33.08	J 110 MGS / 300	33.08	
12.5 - 1/2	J 125 + color* / 300	42.16	J 125 MBW / 300	33.73	J 125 MGS / 300	33.73	

Special shipping conditions apply, see pages 199 - 200.

Color-coated Aluminum

Length = 2.5 m - 8' 2-1/2"		Color-coated aluminum			
H = mm - in.	Profile	\$/ Length	Outside corner	\$/ Unit	
6 - 1/4	J 60 + color*	18.51	EV / J 60 + color*	9.96	
8 - 5/16	J 80 + color*	18.89	EV / J 80 + color*	9.96	
10 - 3/8	J 100 + color*	20.27	EV / J 100 + color*	9.96	
11 - 7/16	J 110 + color*	20.60	EV / J 110 + color*	9.96	
12.5 - 1/2	J 125 + color*	20.91	EV / J 125 + color*	9.96	

***Color Codes**

BW Bright white	W White	SP Sand pebble	PG Classic grey	G Grey	GM Metallic grey
SB Black brown	GS Black				

* To complete the item number, add the **color** code (e.g., J 60 **G**).

Connector	Quantity	\$/ Pkg.
V / J PP4	4	2.72



Note: The anchoring leg of Schluter®-JOLLY is available with a special radius perforation so that the profile can be used to form curves.

- Price surcharge: \$0.70 per foot
- Color-coated aluminum profiles require a relatively large bending radius
- Item No.: R / Profile No. (e.g., R/J 80 TSC)
- For delivery time, please call Customer Service





Schluter®-JOLLY-P

Schluter®-JOLLY-P is a PVC profile featuring an 87° angle designed to finish and protect external corners and other tile edges in wall applications. The vertical wall section of the profile provides a decorative finish and protects adjacent tiles. JOLLY-P in sizes 1/4" (6 mm) and higher features an integrated joint spacer that establishes a defined joint cavity between the tile and the profile.

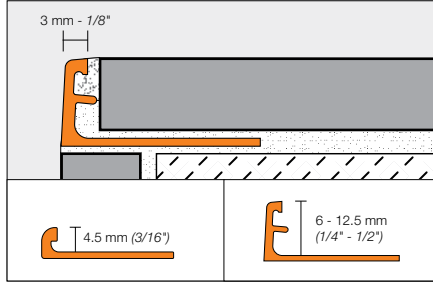

Schluter®-JOLLY-P		
Length = 2.5 m - 8' 2-1/2"	PVC	
H = mm - in.	Item No.	\$ / Length
4.5 - 3/16	color* + 45	6.02
6 - 1/4	color* + 60	6.12
8 - 5/16	color* + 80	6.39
10 - 3/8	color* + 100	6.53
11 - 7/16	color* + 110	6.72
12.5 - 1/2	color* + 125	6.89

10-foot (3.05 m) JOLLY-P Profiles – PVC		
Length = 3.05 m - 10'	Bright white (BW)	
H = mm - in.	Item No.	\$ / Length
8 - 5/16	BW 80 / 300	7.97
10 - 3/8	BW 100 / 300	8.17
12.5 - 1/2	BW 125 / 300	8.61

Special shipping conditions apply, see pages 199 - 200.

***Color Codes**

BW	W	SP	BH	HB	HG	PG	G	GS
Bright white	White	Sand pebble	Bahama	Light beige	Light grey	Classic grey	Grey	Black

* To complete the item number, add the color code (e.g., G 45).

Get perfect cuts!
Schluter®-SNIPS for PVC profiles.
See page 188 for more information.



Schluter®-SCHIENE

Schluter®-SCHIENE is an edging profile featuring an 87° angle designed to finish and protect external corners and other tile edges. Though SCHIENE is typically used in floor applications, the finishes listed in this section are specifically suited for use in wall applications. SCHIENE in sizes 1/4" (6 mm) and higher features an integrated joint spacer that establishes a defined joint cavity between the tile and the profile.

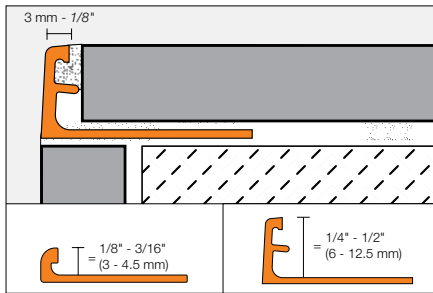

Note: Also available in chrome-plated brass. Contact Customer Service for pricing and availability.

Schluter®-SCHIENE						
Length = 2.5 m - 8' 2-1/2"	Bright black anodized aluminum (AGSG)		Brushed graphite anodized aluminum (AGRB)		Color-coated aluminum	
H = mm - in.	Item No.	\$ / Length	Item No.	\$ / Length	Item No.	\$ / Length
3 - 1/8	-	-	-	-	A 30 + color*	16.90
4.5 - 3/16	A 45 AGSG	17.52	-	-	A 45 + color*	17.52
6 - 1/4	A 60 AGSG	18.51	A 60 AGRB	22.95	A 60 + color*	18.51
8 - 5/16	A 80 AGSG	18.89	A 80 AGRB	24.14	A 80 + color*	18.89
10 - 3/8	A 100 AGSG	20.27	A 100 AGRB	25.35	A 100 + color*	20.27
11 - 7/16	-	-	-	-	A 110 + color*	20.60
12.5 - 1/2	A 125 AGSG	20.91	A 125 AGRB	26.94	A 125 + color*	20.91

***Color Codes**

BW	W	SP	BH	HB	HG
Bright white	White	Sand pebble	Bahama	Light beige	Light grey
PG	G	GM	RB	SB	GS
Classic grey	Grey	Metallic grey	Red brown	Black brown	Black

¹ Red brown (RB) is only available in sizes 80, 100, and 125.
* To complete the item number, add the color code (e.g., A 45 G).

Note: Available in RADIUS, see page 15 for more information.





Schluter®-RONDEC

Schluter®-RONDEC is a finishing and edge-protection profile for tiled edges and outside corners of tiled surfaces. The reveal of the profile forms a symmetrically rounded corner along the surface edge. RONDEC allows for color coordination with tile and grout and the creation of interesting accents in decorative designs. The profile can be combined with the Schluter®-DESIGNLINE border profile for further design options (page 46). RONDEC in aluminum and PVC features an integrated joint spacer that establishes a defined joint cavity between the tile and the profile.

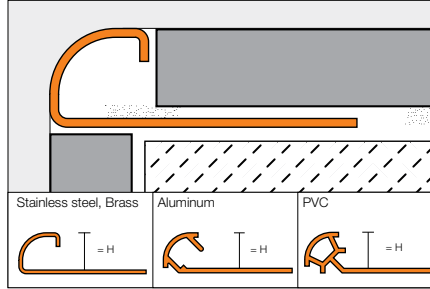

Accessories

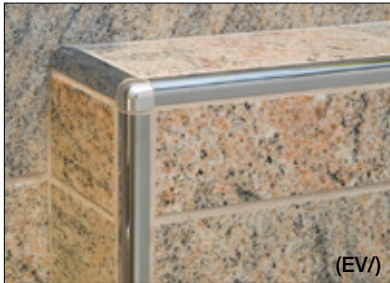

90° Outside corner



90° Inside corner



RONDEC prefabricated corners eliminate the need for a mitered edge.



Corners with item numbers beginning with EV/ are milled out of solid aluminum and corners with item numbers beginning with ED/ are die cast metal.

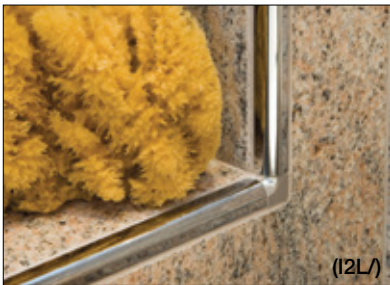

90° Double-leg outside corner (E2L/)



90° Double-leg inside corner (I2L/)

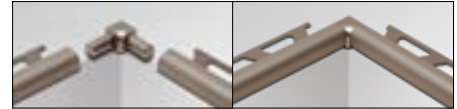

Double-leg corners simplify the framing of smaller elements with the RONDEC profile, such as niches, windows, etc. The legs are detachable for use in applications where a single-leg corner is needed.



Sink corner with 3/8" (10 mm) radius (I2S/)

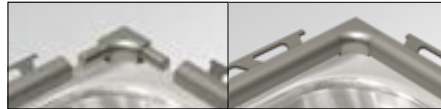

Sink corner with 1-1/2" (38 mm) radius (ISK/)

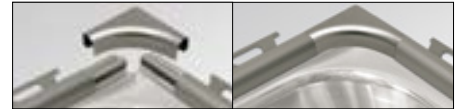

Stainless steel sink corners are used with the RONDEC profile to produce tiled-under sinks. The corners have a large radius (3/8" - 10 mm or 1-1/2" - 38 mm) that allows them to match up to the contour of the most standard sinks. The 3/8" corner piece features a double-leg design for ease of installation, while the 1-1/2" corner includes two stainless steel connectors to maintain the alignment of the corner piece and profiles during installation.

Connector Stainless Steel (V/)



Connector PVC (V/)



RONDEC connectors simplify the alignment of adjacent profile sections. Connectors are made of either PVC for aluminum profiles or stainless steel for stainless steel profiles.



End cap



End caps feature a bendable leg that is inserted into the RONDEC profile, and a brushed stainless steel plate that covers the open area of the profile in applications where the end of the profile is to be left exposed. RONDEC end caps can be used with stainless steel and brushed stainless steel RONDEC profiles.



Stainless Steel 304 (1.4301 = V2A)



Note: RONDEC in sizes 60, 80, 100, and 125 is also available in stainless steel 316L (1.4404 = V4A). Contact customer service for price and availability.

Schluter®-RONDEC								
Length = 2.5 m - 8' 2-1/2"								
Stainless steel 304 (1.4301 = V2A) (E)								
H = mm - in.	Profile	\$ / Length	Outside corner, 90°	\$ / Unit	Sink corner 3/8" (10 mm) radius	\$ / Unit	Sink corner 1-1/2" (38 mm) radius	\$ / Unit
4.5 - 3/16	RO 45 E	46.38	EV/RO 45 E	34.28	-	-	-	-
6 - 1/4	RO 60 E	48.27	EV/RO 60 E	34.28	-	-	-	-
7 - 9/32	RO 70 E	50.06	EV/RO 70 E	36.82	-	-	-	-
8 - 5/16	RO 80 E	50.40	EV/RO 80 E	36.82	I2S/RO 80 EV/2A	55.28	ISK/RO 80 E/38	28.78
9 - 11/32	RO 90 E	53.82	EV/RO 90 E	39.55	-	-	-	-
10 - 3/8	RO 100 E	54.12	EV/RO 100 E	39.55	I2S/RO 100 EV/2A	55.28	ISK/RO 100 E/38	28.78
11 - 7/16	RO 110 E	55.88	EV/RO 110 E	40.93	-	-	-	-
12.5 - 1/2	RO 125 E	57.65	EV/RO 125 E	40.93	I2S/RO 125 EV/2A	55.28	ISK/RO 125 E/38	28.78
15 - 9/16	RO 150 E	65.30	EV/RO 150 E	41.88	-	-	-	-

Length = 2.5 m - 8' 2-1/2"					
Brushed stainless steel 304 (1.4301 = V2A) (EB)			Die cast metal with stainless steel appearance		
H = mm - in.	End cap	\$ / Unit	Outside corner, 90°	Inside corner, 90°	\$ / Unit
6 - 1/4	-	-	ED/RO 60 E	ID/RO 60 E	8.11
8 - 5/16	EK/RO 80 EB	4.92	ED/RO 80 E	ID/RO 80 E	8.11
10 - 3/8	EK/RO 100 EB	4.92	ED/RO 100 E	ID/RO 100 E	8.11
12.5 - 1/2	EK/RO 125 EB	4.92	ED/RO 125 E	ID/RO 125 E	8.11

Length = 2.5 m - 8' 2-1/2"								
Brushed stainless steel 304 (1.4301 = V2A) (EB)								
H = mm - in.	Profile	\$ / Length	Outside corner, 90°	\$ / Unit	Sink corner 3/8" (10 mm) radius	\$ / Unit	End cap	\$ / Unit
6 - 1/4	RO 60 EB	74.04	EV/RO 60 EB	41.59	-	-	-	-
7 - 9/32	RO 70 EB	75.49	EV/RO 70 EB	41.59	-	-	-	-
8 - 5/16	RO 80 EB	77.27	EV/RO 80 EB	41.59	I2S/RO 80 EB/V2A	55.28	EK/RO 80 EB	4.92
9 - 11/32	RO 90 EB	78.82	EV/RO 90 EB	41.59	-	-	-	-
10 - 3/8	RO 100 EB	80.71	EV/RO 100 EB	47.99	I2S/RO 100 EB/V2A	55.28	EK/RO 100 EB	4.92
11 - 7/16	RO 110 EB	82.31	EV/RO 110 EB	47.99	-	-	-	-
12.5 - 1/2	RO 125 EB	84.23	EV/RO 125 EB	47.99	I2S/RO 125 EB/V2A	55.28	EK/RO 125 EB	4.92
15 - 9/16	RO 150 EB	92.68	EV/RO 150 EB	50.85	-	-	-	-

Stainless steel 304 (1.4301 = V2A) (E)		
H = mm - in.	Connector	\$ / Unit
6 - 1/4	V/RO 60 E	6.45
8 - 5/16	V/RO 80 E	6.45
10 - 3/8	V/RO 100 E	6.45
11 - 7/16	V/RO 110 E	6.45
12.5 - 1/2	V/RO 125 E	6.45



Brass



Schluter®-RONDEC						
Length = 2.5 m - 8' 2-1/2"		Chrome-plated solid brass (MC)*	Aluminum with polished chrome finish			
H = mm - in.	Profile	\$ / Length	Outside corner, 90°		Inside corner, 90°	\$ / Unit
6 - 1/4	RO 60 MC	126.92	EV/RO 60 ACG		IV/RO 60 ACG	9.61
8 - 5/16	RO 80 MC	134.20	EV/RO 80 ACG		IV/RO 80 ACG	9.61
10 - 3/8	RO 100 MC	139.97	EV/RO 100 ACG		IV/RO 100 ACG	9.61
12.5 - 1/2	RO 125 MC	147.45	EV/RO 125 ACG		IV/RO 125 ACG	9.61

Anodized Aluminum



Schluter®-RONDEC							
Length = 2.5 m - 8' 2-1/2"		Satin anodized aluminum (AE)					
H = mm - in.	Profile	\$ / Length	Outside corner, 90°	Inside corner, 90°	\$ / Unit	Connector	\$ / Unit
6 - 1/4	RO 60 AE	18.36	EV/RO 60 AE	IV/RO 60 AE	8.11	V/RO 60	2.70
8 - 5/16	RO 80 AE	19.16	EV/RO 80 AE	IV/RO 80 AE	8.11	V/RO 80	2.70
10 - 3/8	RO 100 AE	20.69	EV/RO 100 AE	IV/RO 100 AE	8.11	V/RO 100	2.70
12.5 - 1/2	RO 125 AE	23.11	EV/RO 125 AE	IV/RO 125 AE	8.11	V/RO 125	2.70

H = mm - in.	Double-leg outside corner, 90°	Double-leg inside corner, 90°	\$ / Unit
8 - 5/16	E2L/RO 80 AE	I2L/RO 80 AE	17.39
10 - 3/8	E2L/RO 100 AE	I2L/RO 100 AE	17.39
12.5 - 1/2	E2L/RO 125 AE	I2L/RO 125 AE	17.39

Length = 2.5 m - 8' 2-1/2"		Polished chrome anod. alu. (ACG)					
H = mm - in.	Profile	\$ / Length	Outside corner, 90°	Inside corner, 90°	\$ / Unit	Connector	\$ / Unit
6 - 1/4	RO 60 ACG	22.45	EV/RO 60 ACG	IV/RO 60 ACG	9.61	V/RO 60	2.70
8 - 5/16	RO 80 ACG	25.16	EV/RO 80 ACG	IV/RO 80 ACG	9.61	V/RO 80	2.70
10 - 3/8	RO 100 ACG	27.87	EV/RO 100 ACG	IV/RO 100 ACG	9.61	V/RO 100	2.70
12.5 - 1/2	RO 125 ACG	32.62	EV/RO 125 ACG	IV/RO 125 ACG	9.61	V/RO 125	2.70

H = mm - in.	Double-leg outside corner, 90°	Double-leg inside corner, 90°	\$ / Unit
8 - 5/16	E2L/RO 80 ACG	I2L/RO 80 ACG	16.73
10 - 3/8	E2L/RO 100 ACG	I2L/RO 100 ACG	16.73
12.5 - 1/2	E2L/RO 125 ACG	I2L/RO 125 ACG	16.73

Length = 2.5 m - 8' 2-1/2"		Brushed chrome anod. alu. (ACGB)					
H = mm - in.	Profile	\$ / Length	Outside corner, 90°	Inside corner, 90°	\$ / Unit	Connector	\$ / Unit
6 - 1/4	RO 60 ACGB	23.11	EV/RO 60 ACGB	IV/RO 60 ACGB	15.14	V/RO 60	2.70
8 - 5/16	RO 80 ACGB	25.83	EV/RO 80 ACGB	IV/RO 80 ACGB	15.14	V/RO 80	2.70
10 - 3/8	RO 100 ACGB	29.22	EV/RO 100 ACGB	IV/RO 100 ACGB	15.14	V/RO 100	2.70
12.5 - 1/2	RO 125 ACGB	33.99	EV/RO 125 ACGB	IV/RO 125 ACGB	15.14	V/RO 125	2.70

H = mm - in.	Double-leg outside corner, 90°	Double-leg inside corner, 90°	\$ / Unit
8 - 5/16	E2L/RO 80 ACGB	I2L/RO 80 ACGB	20.63
10 - 3/8	E2L/RO 100 ACGB	I2L/RO 100 ACGB	20.63
12.5 - 1/2	E2L/RO 125 ACGB	I2L/RO 125 ACGB	20.63



Schluter®-RONDEC							
Length = 2.5 m - 8' 2-1/2"	Satin nickel anod. alu. (AT)						
H = mm - in.	Profile	\$/ Length	Outside corner, 90°	Inside corner, 90°	\$/ Unit	Connector	\$/ Unit
6 - 1/4	RO 60 AT	18.79	EV/RO 60 AT	IV/RO 60 AT	8.18	V/RO 60	2.70
8 - 5/16	RO 80 AT	20.07	EV/RO 80 AT	IV/RO 80 AT	8.18	V/RO 80	2.70
10 - 3/8	RO 100 AT	20.97	EV/RO 100 AT	IV/RO 100 AT	8.18	V/RO 100	2.70
12.5 - 1/2	RO 125 AT	23.79	EV/RO 125 AT	IV/RO 125 AT	8.18	V/RO 125	2.70

H = mm - in.	Double-leg outside corner, 90°	Double-leg inside corner, 90°	\$/ Unit
8 - 5/16	E2L/RO 80 AT	I2L/RO 80 AT	17.16
10 - 3/8	E2L/RO 100 AT	I2L/RO 100 AT	17.16
12.5 - 1/2	E2L/RO 125 AT	I2L/RO 125 AT	17.16

Length = 2.5 m - 8' 2-1/2"	Polished nickel anod. alu. (ATG)						
H = mm - in.	Profile	\$/ Length	Outside corner, 90°	Inside corner, 90°	\$/ Unit	Connector	\$/ Unit
6 - 1/4	RO 60 ATG	24.50	EV/RO 60 ATG	IV/RO 60 ATG	9.61	V/RO 60	2.70
8 - 5/16	RO 80 ATG	25.83	EV/RO 80 ATG	IV/RO 80 ATG	9.61	V/RO 80	2.70
10 - 3/8	RO 100 ATG	30.60	EV/RO 100 ATG	IV/RO 100 ATG	9.61	V/RO 100	2.70
12.5 - 1/2	RO 125 ATG	34.67	EV/RO 125 ATG	IV/RO 125 ATG	9.61	V/RO 125	2.70

H = mm - in.	Double-leg outside corner, 90°	Double-leg inside corner, 90°	\$/ Unit
8 - 5/16	E2L/RO 80 ATG	I2L/RO 80 ATG	17.39
10 - 3/8	E2L/RO 100 ATG	I2L/RO 100 ATG	17.39
12.5 - 1/2	E2L/RO 125 ATG	I2L/RO 125 ATG	17.39

Length = 2.5 m - 8' 2-1/2"	Brushed nickel anod. alu. (ATGB)						
H = mm - in.	Profile	\$/ Length	Outside corner, 90°	Inside corner, 90°	\$/ Unit	Connector	\$/ Unit
6 - 1/4	RO 60 ATGB	25.83	EV/RO 60 ATGB	IV/RO 60 ATGB	14.98	V/RO 60	2.70
8 - 5/16	RO 80 ATGB	28.55	EV/RO 80 ATGB	IV/RO 80 ATGB	14.98	V/RO 80	2.70
10 - 3/8	RO 100 ATGB	31.35	EV/RO 100 ATGB	IV/RO 100 ATGB	14.98	V/RO 100	2.70
12.5 - 1/2	RO 125 ATGB	36.36	EV/RO 125 ATGB	IV/RO 125 ATGB	14.98	V/RO 125	2.70

H = mm - in.	Double-leg outside corner, 90°	Double-leg inside corner, 90°	\$/ Unit
8 - 5/16	E2L/RO 80 ATGB	I2L/RO 80 ATGB	21.44
10 - 3/8	E2L/RO 100 ATGB	I2L/RO 100 ATGB	21.44
12.5 - 1/2	E2L/RO 125 ATGB	I2L/RO 125 ATGB	21.44

Length = 2.5 m - 8' 2-1/2"	Satin copper anod. alu. (AK)						
H = mm - in.	Profile	\$/ Length	Outside corner, 90°	Inside corner, 90°	\$/ Unit	Connector	\$/ Unit
6 - 1/4	RO 60 AK	19.72	EV/RO 60 AK	IV/RO 60 AK	8.11	V/RO 60	2.70
8 - 5/16	RO 80 AK	21.07	EV/RO 80 AK	IV/RO 80 AK	8.11	V/RO 80	2.70
10 - 3/8	RO 100 AK	22.42	EV/RO 100 AK	IV/RO 100 AK	8.11	V/RO 100	2.70
12.5 - 1/2	RO 125 AK	23.79	EV/RO 125 AK	IV/RO 125 AK	8.11	V/RO 125	2.70

H = mm - in.	Double-leg outside corner, 90°	Double-leg inside corner, 90°	\$/ Unit
8 - 5/16	E2L/RO 80 AK	I2L/RO 80 AK	16.88
10 - 3/8	E2L/RO 100 AK	I2L/RO 100 AK	16.88
12.5 - 1/2	E2L/RO 125 AK	I2L/RO 125 AK	16.88



Schluter®-RONDEC							
Length = 2.5 m - 8' 2-1/2"	Polished copper anod. alu. (AKG)						
H = mm - in.	Profile	\$ / Length	Outside corner, 90°	Inside corner, 90°	\$ / Unit	Connector	\$ / Unit
6 - 1/4	RO 60 AKG	24.50	EV/RO 60 AKG	IV/RO 60 AKG	9.61	V/RO 60	2.70
8 - 5/16	RO 80 AKG	25.83	EV/RO 80 AKG	IV/RO 80 AKG	9.61	V/RO 80	2.70
10 - 3/8	RO 100 AKG	30.60	EV/RO 100 AKG	IV/RO 100 AKG	9.61	V/RO 100	2.70
12.5 - 1/2	RO 125 AKG	34.67	EV/RO 125 AKG	IV/RO 125 AKG	9.61	V/RO 125	2.70

H = mm - in.	Double-leg outside corner, 90°	Double-leg inside corner, 90°	\$ / Unit
8 - 5/16	E2L/RO 80 AKG	I2L/RO 80 AKG	17.22
10 - 3/8	E2L/RO 100 AKG	I2L/RO 100 AKG	17.22
12.5 - 1/2	E2L/RO 125 AKG	I2L/RO 125 AKG	17.22

Length = 2.5 m - 8' 2-1/2"	Brushed copper anod. alu. (AKGB)						
H = mm - in.	Profile	\$ / Length	Outside corner, 90°	Inside corner, 90°	\$ / Unit	Connector	\$ / Unit
6 - 1/4	RO 60 AKGB	25.83	EV/RO 60 AKGB	IV/RO 60 AKGB	15.14	V/RO 60	2.70
8 - 5/16	RO 80 AKGB	28.55	EV/RO 80 AKGB	IV/RO 80 AKGB	15.14	V/RO 80	2.70
10 - 3/8	RO 100 AKGB	31.95	EV/RO 100 AKGB	IV/RO 100 AKGB	15.14	V/RO 100	2.70
12.5 - 1/2	RO 125 AKGB	36.36	EV/RO 125 AKGB	IV/RO 125 AKGB	15.14	V/RO 125	2.70

H = mm - in.	Double-leg outside corner, 90°	Double-leg inside corner, 90°	\$ / Unit
8 - 5/16	E2L/RO 80 AKGB	I2L/RO 80 AKGB	21.02
10 - 3/8	E2L/RO 100 AKGB	I2L/RO 100 AKGB	21.02
12.5 - 1/2	E2L/RO 125 AKGB	I2L/RO 125 AKGB	21.02

Length = 2.5 m - 8' 2-1/2"	Brushed antique bronze anod. alu. (ABGB)						
H = mm - in.	Profile	\$ / Length	Outside corner, 90°	Inside corner, 90°	\$ / Unit	Connector	\$ / Unit
6 - 1/4	RO 60 ABGB	25.83	EV/RO 60 ABGB	IV/RO 60 ABGB	15.14	V/RO 60	2.70
8 - 5/16	RO 80 ABGB	28.55	EV/RO 80 ABGB	IV/RO 80 ABGB	15.14	V/RO 80	2.70
10 - 3/8	RO 100 ABGB	31.95	EV/RO 100 ABGB	IV/RO 100 ABGB	15.14	V/RO 100	2.70
12.5 - 1/2	RO 125 ABGB	36.36	EV/RO 125 ABGB	IV/RO 125 ABGB	15.14	V/RO 125	2.70

H = mm - in.	Double-leg outside corner, 90°	Double-leg inside corner, 90°	\$ / Unit
8 - 5/16	E2L/RO 80 ABGB	I2L/RO 80 ABGB	21.02
10 - 3/8	E2L/RO 100 ABGB	I2L/RO 100 ABGB	21.02
12.5 - 1/2	E2L/RO 125 ABGB	I2L/RO 125 ABGB	21.02

Length = 2.5 m - 8' 2-1/2"	Satin brass anod. alu. (AM)						
H = mm - in.	Profile	\$ / Length	Outside corner, 90°	Inside corner, 90°	\$ / Unit	Connector	\$ / Unit
6 - 1/4	RO 60 AM	19.72	EV/RO 60 AM	IV/RO 60 AM	8.18	V/RO 60	2.70
8 - 5/16	RO 80 AM	22.45	EV/RO 80 AM	IV/RO 80 AM	8.18	V/RO 80	2.70
10 - 3/8	RO 100 AM	25.16	EV/RO 100 AM	IV/RO 100 AM	8.18	V/RO 100	2.70
12.5 - 1/2	RO 125 AM	29.22	EV/RO 125 AM	IV/RO 125 AM	8.18	V/RO 125	2.70

H = mm - in.	Double-leg outside corner, 90°	Double-leg inside corner, 90°	\$ / Unit
8 - 5/16	E2L/RO 80 AM	I2L/RO 80 AM	16.88
10 - 3/8	E2L/RO 100 AM	I2L/RO 100 AM	16.88
12.5 - 1/2	E2L/RO 125 AM	I2L/RO 125 AM	16.88



Schluter®-RONDEC							
Length = 2.5 m - 8' 2-1/2"		Polished brass anod. alu. (AMG)					
H = mm - in.	Profile	\$/ Length	Outside corner, 90°	Inside corner, 90°	\$/ Unit	Connector	\$/ Unit
6 - 1/4	RO 60 AMG	23.11	EV/RO 60 AMG	IV/RO 60 AMG	9.61	V/RO 60	2.70
8 - 5/16	RO 80 AMG	25.83	EV/RO 80 AMG	IV/RO 80 AMG	9.61	V/RO 80	2.70
10 - 3/8	RO 100 AMG	29.22	EV/RO 100 AMG	IV/RO 100 AMG	9.61	V/RO 100	2.70
12.5 - 1/2	RO 125 AMG	33.31	EV/RO 125 AMG	IV/RO 125 AMG	9.61	V/RO 125	2.70

H = mm - in.	Double-leg outside corner, 90°	Double-leg inside corner, 90°	\$/ Unit
8 - 5/16	E2L/RO 80 AMG	I2L/RO 80 AMG	16.88
10 - 3/8	E2L/RO 100 AMG	I2L/RO 100 AMG	16.88
12.5 - 1/2	E2L/RO 125 AMG	I2L/RO 125 AMG	16.88

Length = 2.5 m - 8' 2-1/2"		Brushed brass anod. alu. (AMGB)					
H = mm - in.	Profile	\$/ Length	Outside corner, 90°	Inside corner, 90°	\$/ Unit	Connector	\$/ Unit
6 - 1/4	RO 60 AMGB	24.47	EV/RO 60 AMGB	IV/RO 60 AMGB	15.42	V/RO 60	2.70
8 - 5/16	RO 80 AMGB	27.16	EV/RO 80 AMGB	IV/RO 80 AMGB	15.42	V/RO 80	2.70
10 - 3/8	RO 100 AMGB	30.60	EV/RO 100 AMGB	IV/RO 100 AMGB	15.42	V/RO 100	2.70
12.5 - 1/2	RO 125 AMGB	34.67	EV/RO 125 AMGB	IV/RO 125 AMGB	15.42	V/RO 125	2.70

H = mm - in.	Double-leg outside corner, 90°	Double-leg inside corner, 90°	\$/ Unit
8 - 5/16	E2L/RO 80 AMGB	I2L/RO 80 AMGB	21.44
10 - 3/8	E2L/RO 100 AMGB	I2L/RO 100 AMGB	21.44
12.5 - 1/2	E2L/RO 125 AMGB	I2L/RO 125 AMGB	21.44

Length = 2.5 m - 8' 2-1/2"		Graphite anod. alu. (AGR)					
H = mm - in.	Profile	\$/ Length	Outside corner, 90°	Inside corner, 90°	\$/ Unit	Connector	\$/ Unit
6 - 1/4	RO 60 AGR	20.12	EV/RO 60 AGR	IV/RO 60 AGR	8.27	V/RO 60	2.70
8 - 5/16	RO 80 AGR	21.50	EV/RO 80 AGR	IV/RO 80 AGR	8.27	V/RO 80	2.70
10 - 3/8	RO 100 AGR	22.89	EV/RO 100 AGR	IV/RO 100 AGR	8.27	V/RO 100	2.70
12.5 - 1/2	RO 125 AGR	24.26	EV/RO 125 AGR	IV/RO 125 AGR	8.27	V/RO 125	2.70

H = mm - in.	Double-leg outside corner, 90°	Double-leg inside corner, 90°	\$/ Unit
8 - 5/16	E2L/RO 80 AGR	I2L/RO 80 AGR	17.22
10 - 3/8	E2L/RO 100 AGR	I2L/RO 100 AGR	17.22
12.5 - 1/2	E2L/RO 125 AGR	I2L/RO 125 AGR	17.22

Length = 2.5 m - 8' 2-1/2"		Bright black anod. alu. (AGSG)					
H = mm - in.	Profile	\$/ Length	Outside corner, 90°	Inside corner, 90°	\$/ Unit	Connector	\$/ Unit
6 - 1/4	RO 60 AGSG	24.97	EV/RO 60 AGSG	IV/RO 60 AGSG	10.10	V/RO 60	2.70
8 - 5/16	RO 80 AGSG	26.33	EV/RO 80 AGSG	IV/RO 80 AGSG	10.10	V/RO 80	2.70
10 - 3/8	RO 100 AGSG	31.19	EV/RO 100 AGSG	IV/RO 100 AGSG	10.10	V/RO 100	2.70
12.5 - 1/2	RO 125 AGSG	35.36	EV/RO 125 AGSG	IV/RO 125 AGSG	10.10	V/RO 125	2.70

H = mm - in.	Double-leg outside corner, 90°	Double-leg inside corner, 90°	\$/ Unit
8 - 5/16	E2L/RO 80 AGSG	I2L/RO 80 AGSG	17.56
10 - 3/8	E2L/RO 100 AGSG	I2L/RO 100 AGSG	17.56
12.5 - 1/2	E2L/RO 125 AGSG	I2L/RO 125 AGSG	17.56



Schluter®-RONDEC

Length = 2.5 m - 8' 2-1/2"	Brushed black anod. alu. (AGSB)						
H = mm - in.	Profile	\$ / Length	Outside corner, 90°	Inside corner, 90°	\$ / Unit	Connector	\$ / Unit
6 - 1/4	RO 60 AGSB	25.83	EV/RO 60 AGSB	IV/RO 60 AGSB	15.27	V/RO 60	2.70
8 - 5/16	RO 80 AGSB	28.55	EV/RO 80 AGSB	IV/RO 80 AGSB	15.27	V/RO 80	2.70
10 - 3/8	RO 100 AGSB	31.95	EV/RO 100 AGSB	IV/RO 100 AGSB	15.27	V/RO 100	2.70
12.5 - 1/2	RO 125 AGSB	35.33	EV/RO 125 AGSB	IV/RO 125 AGSB	15.27	V/RO 125	2.70

H = mm - in.	Double-leg outside corner, 90°	Double-leg inside corner, 90°	\$ / Unit
8 - 5/16	E2L/RO 80 AGSB	I2L/RO 80 AGSB	21.02
10 - 3/8	E2L/RO 100 AGSB	I2L/RO 100 AGSB	21.02
12.5 - 1/2	E2L/RO 125 AGSB	I2L/RO 125 AGSB	21.02

10-foot (3.05 m) RONDEC Profiles – Anodized Aluminum

Length = 3.05 m - 10'	Satin anod. alu. (AE)		Polished chrome anod. alu. (ACG)		Satin nickel anod. alu. (AT)	
H = mm - in.	Profile	\$ / Length	Profile	\$ / Length	Profile	\$ / Length
8 - 5/16	RO 80 AE / 300	23.93	RO 80 ACG / 300	31.46	RO 80 AT / 300	25.07
10 - 3/8	RO 100 AE / 300	25.87	RO 100 ACG / 300	34.84	RO 100 AT / 300	26.22
12.5 - 1/2	RO 125 AE / 300	28.87	RO 125 ACG / 300	40.77	RO 125 AT / 300	29.75

Special shipping conditions apply, see pages 199 - 200.



Schluter®-RONDEC in brushed chrome (page 30)



Schluter®-TRENDLINE Textured Color-coated Aluminum



Schluter®-RONDEC							
Length = 2.5 m - 8' 2-1/2"		Textured color-coated aluminum (TS)					
H = mm - in.	Profile	\$ / Length	Outside corner, 90°	Inside corner, 90°	\$ / Unit	Connector	\$ / Unit
6 - 1/4	RO 60 + color*	42.49	EV/RO 60 + color*	IV/RO 60 + color*	15.15	V/RO 60	2.70
8 - 5/16	RO 80 + color*	43.36	EV/RO 80 + color*	IV/RO 80 + color*	15.15	V/RO 80	2.70
10 - 3/8	RO 100 + color*	44.76	EV/RO 100 + color*	IV/RO 100 + color*	15.15	V/RO 100	2.70
11 - 7/16	RO 110 + color*	45.26	EV/RO 110 + color*	IV/RO 110 + color*	15.15	V/RO 110	2.70
12.5 - 1/2	RO 125 + color*	45.72	EV/RO 125 + color*	IV/RO 125 + color*	15.15	V/RO 125	2.70

***Color Codes**

Ivory	Greige	Stone grey	Cream	Beige	Rustic brown	Bronze	Pewter	Light anthracite	Dark anthracite

* To complete the item number, add the color code (e.g., RO 60 TSC).

Matte White and Matte Black

Length = 2.5 m - 8' 2-1/2"		Textured color-coated aluminum					
H = mm - in.	Profile	\$ / Length	Outside corner, 90° (die cast)	Inside corner, 90° (die cast)	\$ / Unit	Connector	\$ / Unit
6 - 1/4	RO 60 + color*	33.99	ED/RO 60 + color*	ID/RO 60 + color*	11.76	V/RO 60	2.70
8 - 5/16	RO 80 + color*	34.69	ED/RO 80 + color*	ID/RO 80 + color*	11.76	V/RO 80	2.70
10 - 3/8	RO 100 + color*	35.81	ED/RO 100 + color*	ID/RO 100 + color*	11.76	V/RO 100	2.70
11 - 7/16	RO 110 + color*	36.22	ED/RO 110 + color*	ID/RO 110 + color*	11.76	V/RO 110	2.70
12.5 - 1/2	RO 125 + color*	36.57	ED/RO 125 + color*	ID/RO 125 + color*	11.76	V/RO 125	2.70

***Color Codes**

		* To complete the item number, add the color code (e.g., RO 60 MGS).
Matte white	Matte black	

10-foot (3.05 m) RONDEC Profiles – Textured Color-coated Aluminum							
Length = 3.05 m - 10'		Textured color-coated aluminum (TS)		Matte white (MBW)		Matte black (MGS)	
H = mm - in.	Profile	\$ / Length	Profile	\$ / Length	Profile	\$ / Length	
6 - 1/4	RO 60 + color* / 300	53.11	RO 60 MBW / 300	42.49	RO 60 MGS / 300	42.49	
8 - 5/16	RO 80 + color* / 300	54.20	RO 80 MBW / 300	43.36	RO 80 MGS / 300	43.36	
10 - 3/8	RO 100 + color* / 300	55.97	RO 100 MBW / 300	44.76	RO 100 MGS / 300	44.76	
11 - 7/16	RO 110 + color* / 300	56.57	RO 110 MBW / 300	45.27	RO 110 MGS / 300	45.27	
12.5 - 1/2	RO 125 + color* / 300	57.16	RO 125 MBW / 300	45.72	RO 125 MGS / 300	45.72	

Special shipping conditions apply, see pages 199 - 200.



Color-coated Aluminum



Schluter®-RONDEC							
Length = 2.5 m - 8' 2-1/2"		Color-coated aluminum (AC)					
H = mm - in.	Profile	\$ / Length	Outside corner, 90° (die cast)	Inside corner, 90° (die cast)	\$ / Unit	Connector	\$ / Unit
6 - 1/4	RO 60 + color*	21.60	ED/RO 60 + color*	ID/RO 60 + color*	4.87	V/RO 60	2.70
8 - 5/16	RO 80 + color*	24.20	ED/RO 80 + color*	ID/RO 80 + color*	4.87	V/RO 80	2.70
10 - 3/8	RO 100 + color*	26.54	ED/RO 100 + color*	ID/RO 100 + color*	4.87	V/RO 100	2.70
12.5 - 1/2	RO 125 + color*	33.17	ED/RO 125 + color*	ID/RO 125 + color*	4.87	V/RO 125	2.70

*Color Codes

Bright white	White	Sand pebble	Bahama	Light beige	Light grey	Classic grey	Grey	Metallic grey	Black brown	Black

* To complete the item number, add the color code (e.g., RO 60 G).

PVC



Length = 2.5 m - 8' 2-1/2"		PVC (P)				
H = mm - in.	Profile	\$ / Length	Outside corner, 90°	Inside corner, 90°	\$ / Unit	
6 - 1/4	PRO 60 + color*	7.49	E/PRO 60 + color*	I/PRO 60 + color*	2.96	
8 - 5/16	PRO 80 + color*	7.89	E/PRO 80 + color*	I/PRO 80 + color*	2.96	
10 - 3/8	PRO 100 + color*	8.41	E/PRO 100 + color*	I/PRO 100 + color*	2.96	
11 - 7/16	PRO 110 + color*	9.45	E/PRO 110 + color*	I/PRO 110 + color*	2.96	
12.5 - 1/2	PRO 125 + color*	10.52	E/PRO 125 + color*	I/PRO 125 + color*	2.96	

*Color Codes

Bright white	White	Sand pebble	Bahama	Light beige	Light grey	Classic grey	Grey	Black

* To complete the item number, add the color code (e.g., PRO 60 G).



Schluter®-RONDEC
in matte white (page 35)



Schluter®-QUADEC

Schluter®-QUADEC is a finishing and edge-protection profile for tiled edges and outside corners of tiled surfaces. The reveal of the profile forms a square outer corner along the surface edge. QUADEC allows for modern decorative design and interesting contrasts. The profile can be combined with the Schluter®-QUADEC-FS (page 41) feature strip profile and/or the Schluter®-DESIGNLINE border profile for further design options (page 46). QUADEC, in stainless steel, can also be used as a stair nosing or floor transition profile. QUADEC in aluminum and PVC feature an integrated joint spacer that establishes a defined joint cavity between the tile and the profile.

Note: Also available in chrome-plated brass, and stainless steel 316L (1.4404 = V4A). Contact Customer Service for pricing and availability.

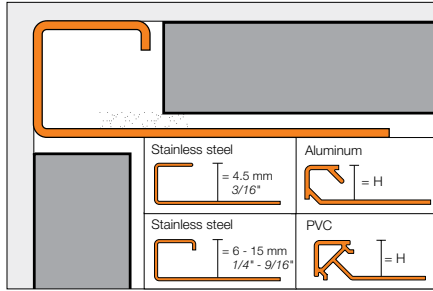

Inside/outside corner/end cap (EV/)

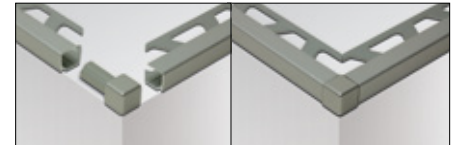
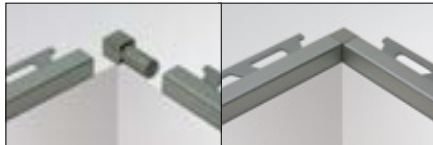

Stainless Steel 304 (1.4301 = V2A)

Schluter®-QUADEC						
Length = 2.5 m - 8' 2-1/2"	Stainless steel 304 (1.4301 = V2A) (E)					
H = mm - in.	Profile	\$ / Length	Inside/outside corner	\$ / Unit	Connector	\$ / Unit
4.5 - 3/16	Q 45 E	44.47	EV/Q 45 E	35.80	-	-
6 - 1/4	Q 60 E	51.06	EV/Q 60 E	39.25	V/RO 60 E	6.45
7 - 9/32	Q 70 E	52.98	EV/Q 70 E	39.80	-	-
8 - 5/16	Q 80 E	53.31	EV/Q 80 E	40.33	V/RO 80 E	6.45
9 - 11/32	Q 90 E	56.84	EV/Q 90 E	41.76	-	-
10 - 3/8	Q 100 E	57.26	EV/Q 100 E	43.56	V/RO 100 E	6.45
11 - 7/16	Q 110 E	59.26	EV/Q 110 E	44.23	V/RO 110 E	6.45
12.5 - 1/2	Q 125 E	61.00	EV/Q 125 E	44.71	V/RO 125 E	6.45
14 - 17/32	Q 140 E	65.33	EV/Q 140 E	46.48	-	-
15 - 9/16	Q 150 E	67.96	EV/Q 150 E	49.85	-	-

Length = 2.5 m - 8' 2-1/2"	Brushed stainless steel 304 (1.4301 = V2A) (EB)					
H = mm - in.	Profile	\$ / Length	Inside/outside corner	\$ / Unit	Connector	\$ / Unit
6 - 1/4	Q 60 EB	75.12	EV/Q 60 EB	47.37	V/RO 60 E	6.45
7 - 9/32	Q 70 EB	77.96	EV/Q 70 EB	47.88	-	-
8 - 5/16	Q 80 EB	80.78	EV/Q 80 EB	48.36	V/RO 80 E	6.45
9 - 11/32	Q 90 EB	83.64	EV/Q 90 EB	50.06	-	-
10 - 3/8	Q 100 EB	86.76	EV/Q 100 EB	52.23	V/RO 100 E	6.45
11 - 7/16	Q 110 EB	89.79	EV/Q 110 EB	53.01	V/RO 110 E	6.45
12.5 - 1/2	Q 125 EB	92.43	EV/Q 125 EB	53.52	V/RO 125 E	6.45
14 - 17/32	Q 140 EB	94.76	EV/Q 140 EB	54.22	-	-
15 - 9/16	Q 150 EB	96.12	EV/Q 150 EB	55.68	-	-



Anodized Aluminum

Schluter®-QUADEC										
Length = 2.5 m - 8' 2-1/2"	Satin anodized aluminum (AE)				Polished chrome anodized aluminum (ACG)				Connector	
H = mm - in.	Profile	\$ / Length	Inside/outside corner	\$ / Unit	Profile	\$ / Length	Inside/outside corner	\$ / Unit	Item No.	\$ / Unit
4.5 - 3/16	Q 45 AE	18.46	EV/Q 45 AE	8.74	Q 45 ACG	23.20	EV/Q 45 ACG	10.37	-	-
6 - 1/4	Q 60 AE	19.24	EV/Q 60 AE	8.74	Q 60 ACG	24.17	EV/Q 60 ACG	10.37	V/Q 60	2.70
8 - 5/16	Q 80 AE	20.06	EV/Q 80 AE	8.74	Q 80 ACG	27.23	EV/Q 80 ACG	10.37	V/RO 80	2.70
10 - 3/8	Q 100 AE	21.69	EV/Q 100 AE	8.74	Q 100 ACG	30.03	EV/Q 100 ACG	10.37	V/RO 100	2.70
12.5 - 1/2	Q 125 AE	24.21	EV/Q 125 AE	8.74	Q 125 ACG	35.18	EV/Q 125 ACG	10.37	V/RO 125	2.70
15 - 9/16	Q 150 AE	27.31	EV/Q 150 AE	9.88	-	-	-	-	-	-
20 - 3/4	Q 200 AE	29.91	EV/Q 200 AE	9.88	-	-	-	-	-	-

Length = 2.5 m - 8' 2-1/2"	Satin nickel anodized aluminum (AT)				Brushed nickel anodized aluminum (ATGB)				Connector	
H = mm - in.	Profile	\$ / Length	Inside/outside corner	\$ / Unit	Profile	\$ / Length	Inside/outside corner	\$ / Unit	Item No.	\$ / Unit
4.5 - 3/16	Q 45 AT	19.45	EV/Q 45 AT	8.58	-	-	-	-	-	-
6 - 1/4	Q 60 AT	20.26	EV/Q 60 AT	8.58	-	-	-	-	V/Q 60	2.70
8 - 5/16	Q 80 AT	21.65	EV/Q 80 AT	8.58	Q 80 ATGB	26.53	EV/Q 80 ATGB	15.87	V/RO 80	2.70
10 - 3/8	Q 100 AT	23.06	EV/Q 100 AT	8.58	Q 100 ATGB	29.52	EV/Q 100 ATGB	15.87	V/RO 100	2.70
12.5 - 1/2	Q 125 AT	25.68	EV/Q 125 AT	8.58	Q 125 ATGB	31.89	EV/Q 125 ATGB	15.87	V/RO 125	2.70

Length = 2.5 m - 8' 2-1/2"	Brushed antique bronze anodized aluminum (ABGB)				Connector	
H = mm - in.	Profile	\$ / Length	Inside/outside corner	\$ / Unit	Item No.	\$ / Unit
6 - 1/4	Q 60 ABGB	25.96	EV/Q 60 ABGB	15.87	V/Q 60	2.70
8 - 5/16	Q 80 ABGB	26.53	EV/Q 80 ABGB	15.87	V/RO 80	2.70
10 - 3/8	Q 100 ABGB	29.52	EV/Q 100 ABGB	15.87	V/RO 100	2.70
12.5 - 1/2	Q 125 ABGB	31.89	EV/Q 125 ABGB	15.87	V/RO 125	2.70

10-foot (3.05 m) QUADEC Profiles – Anodized Aluminum		
Length = 3.05 m - 10'	Polished chrome anodized aluminum (ACG)	
H = mm - in.	Profile	\$ / Length
8 - 5/16	Q 80 ACG / 300	34.05
10 - 3/8	Q 100 ACG / 300	37.54
12.5 - 1/2	Q 125 ACG / 300	43.98

Special shipping conditions apply, see pages 199 - 200.



Schluter®-TRENDLINE Textured Color-coated Aluminum

Schluter®-QUADEC						
Length = 2.5 m - 8' 2-1/2"	Textured color-coated aluminum (TS)					
H = mm - in.	Profile	\$ / Length	Inside/outside corner	\$ / Unit	Connector	\$ / Unit
4.5 - 3/16	Q 45 + color*	41.25	EV/Q 45 + color*	16.49	-	-
6 - 1/4	Q 60 + color*	42.08	EV/Q 60 + color*	16.49	V/Q 60	2.70
8 - 5/16	Q 80 + color*	42.94	EV/Q 80 + color*	16.49	V/RO 80	2.70
10 - 3/8	Q 100 + color*	44.10	EV/Q 100 + color*	16.49	V/RO 100	2.70
11 - 7/16	Q 110 + color*	44.71	EV/Q 110 + color*	16.49	V/RO 110	2.70
12.5 - 1/2	Q 125 + color*	45.14	EV/Q 125 + color*	16.49	V/RO 125	2.70



***Color Codes**

Ivory	Greige	Stone grey	Cream	Beige	Rustic brown	Bronze	Pewter	Light anthracite	Dark anthracite

* To complete the item number, add the color code (e.g., Q 60 TSC).

Matte White and Matte Black

Length = 2.5 m - 8' 2-1/2"	Textured color-coated aluminum					
H = mm - in.	Profile	\$ / Length	Inside/outside corner	\$ / Unit	Connector	\$ / Unit
4.5 - 3/16	Q 45 + color*	32.69	EV/Q 45 + color*	16.49	-	-
6 - 1/4	Q 60 + color*	33.34	EV/Q 60 + color*	16.49	V/Q 60	2.70
8 - 5/16	Q 80 + color*	34.03	EV/Q 80 + color*	16.49	V/RO 80	2.70
10 - 3/8	Q 100 + color*	35.14	EV/Q 100 + color*	16.49	V/RO 100	2.70
11 - 7/16	Q 110 + color*	35.54	EV/Q 110 + color*	16.49	V/RO 110	2.70
12.5 - 1/2	Q 125 + color*	35.89	EV/Q 125 + color*	16.49	V/RO 125	2.70

***Color Codes**

		* To complete the item number, add the color code (e.g., Q 60 MGS).
Matte white	Matte black	

10-foot (3.05 m) QUADEC Profiles – Textured Color-coated Aluminum						
Length = 3.05 m - 10'	Textured color-coated aluminum (TS)		Matte white (MBW)		Matte black (MGS)	
H = mm - in.	Profile	\$ / Length	Profile	\$ / Length	Profile	\$ / Length
6 - 1/4	Q 60 + color* / 300	52.60	Q 60 MBW / 300	41.68	Q 60 MGS / 300	41.68
8 - 5/16	Q 80 + color* / 300	53.67	Q 80 MBW / 300	42.55	Q 80 MGS / 300	42.55
10 - 3/8	Q 100 + color* / 300	55.12	Q 100 MBW / 300	43.92	Q 100 MGS / 300	43.92
11 - 7/16	Q 110 + color* / 300	55.88	Q 110 MBW / 300	44.42	Q 110 MGS / 300	44.42
12.5 - 1/2	Q 125 + color* / 300	56.44	Q 125 MBW / 300	44.85	Q 125 MGS / 300	44.85

Special shipping conditions apply, see pages 199 - 200.



Color-coated Aluminum

Schluter®-QUADEC				
Length = 2.5 m - 8' 2-1/2"	Color-coated aluminum (AC)			
H = mm - in.	Profile	\$ / Length	Outside corner, 90° (die cast)	\$ / Unit
4.5 - 3/16	Q 45 + color*	19.92	ED/Q 45 + color*	4.78
6 - 1/4	Q 60 + color*	21.41	ED/Q 60 + color*	4.78
8 - 5/16	Q 80 + color*	22.65	ED/Q 80 + color*	4.78
10 - 3/8	Q 100 + color*	23.90	ED/Q 100 + color*	4.78
11 - 7/16	Q 110 + color*	24.64	ED/Q 110 + color*	4.78
12.5 - 1/2	Q 125 + color*	26.15	ED/Q 125 + color*	4.78

***Color Codes**

* To complete the item number, add the color code (e.g., Q 45 PG).

PVC

Length = 2.5 m - 8' 2-1/2"	PVC (P)			
H = mm - in.	Profile	\$ / Length	Outside corner, 90°	\$ / Unit
6 - 1/4	PQ 60 + color*	7.81	E/PQ 60 + color*	2.91
8 - 5/16	PQ 80 + color*	8.22	E/PQ 80 + color*	2.91
10 - 3/8	PQ 100 + color*	8.77	E/PQ 100 + color*	2.91
11 - 7/16	PQ 110 + color*	9.88	E/PQ 110 + color*	2.91
12.5 - 1/2	PQ 125 + color*	10.98	E/PQ 125 + color*	2.91

***Color Codes**

* To complete the item number, add the color code (e.g., PQ 80 PG).



Schluter®-QUADEC in cream (page 39)



Schluter®-QUADEC-K

Schluter®-QUADEC-K is a variant of the QUADEC profile without an anchoring leg. It features an open cavity that is filled with thin-set mortar to secure the profile in the assembly. Alternatively, the profile may be installed with an adhesive such as Schluter®-KERDI-FIX. QUADEC-K is installed in wall applications (e.g., wainscotings and bases) with coverings up to 1/2" (12.5 mm) thick. The profile is particularly suited for finishing edges in retrofit applications, such as thin porcelain panel installation over existing wall tiles.

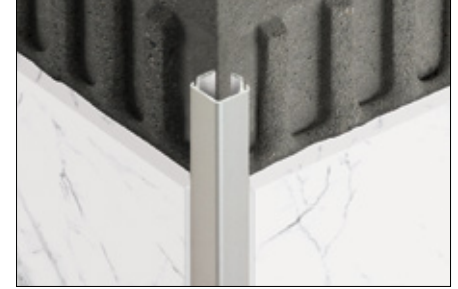
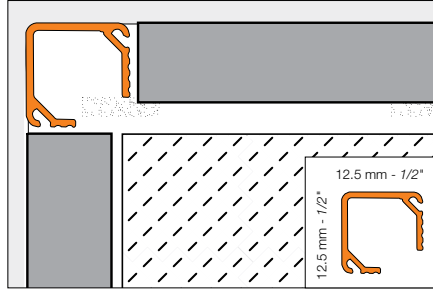

Schluter®-QUADEC-K												
Length = 2.5 m - 8' 2-1/2"	Satin anodized aluminum (AE)						Polished chrome anod. alu. (ACG)					
H = mm - in.	Profile	\$ / Length	Inside/outside corner	\$ / Unit	Connector	\$ / Unit	Profile	\$ / Length	Inside/outside corner	\$ / Unit	Connector	\$ / Unit
12.5 - 1/2	Q 125 AE K	22.22	EV/Q 125 AE	8.74	V/RO 125	2.70	Q 125 ACG K	26.24	EV/Q 125 ACG	10.37	V/RO 125	2.70
Length = 2.5 m - 8' 2-1/2"	Satin nickel anod. alu. (AT)						Brushed antique bronze anod. alu. (ABGB)					
H = mm - in.	Profile	\$ / Length	Inside/outside corner	\$ / Unit	Connector	\$ / Unit	Profile	\$ / Length	Inside/outside corner	\$ / Unit	Connector	\$ / Unit
12.5 - 1/2	Q 125 AT K	24.31	EV/Q 125 AT	8.58	V/RO 125	2.70	Q 125 ABGB K	28.73	EV/Q 125 ABGB	15.87	V/RO 125	2.70

Schluter®-QUADEC-FS

Schluter®-QUADEC-FS is a double-rail feature strip profile that features a recessed section to which field or accent tile is bonded. The profile can be used to produce accents in tile fields on walls, chair rails, and various other decorative applications. The profile can be combined with the Schluter®-QUADEC (page 37) finishing and edge-protection profile. QUADEC-FS features integrated joint spacers that establish defined joint cavities between the accent tile and the profile.

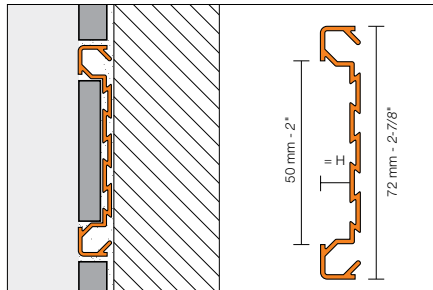

Inside/outside corner / End cap (EV/)



Note: The universal accessory piece can be used to produce a 90° inside corner, 90° outside corner, and end cap.

Schluter®-QUADEC-FS									
Length = 2.5 m - 8' 2-1/2"	Satin anodized aluminum (AE)					Polished chrome anod. alu. (ACG)			
H = mm - in.	Profile	\$ / Length	Inside/outside corner	\$ / Unit	Profile	\$ / Length	Inside/outside corner	\$ / Unit	
8 - 5/16	QF8/50 AE	39.18	EV/QF8/50 AE	26.16	QF8/50 ACG	52.11	EV/QF8/50 ACG	30.97	
Length = 2.5 m - 8' 2-1/2"	Satin nickel anod. alu. (AT)					Brushed antique bronze anod. alu. (ABGB)			
H = mm - in.	Profile	\$ / Length	Inside/outside corner	\$ / Unit	Profile	\$ / Length	Inside/outside corner	\$ / Unit	
8 - 5/16	QF8/50 AT	41.49	EV/QF8/50 AT	26.16	QF8/50 ABGB	56.22	EV/QF8/50 ABGB	33.57	



Schluter®-FINEC-SQ

Schluter®-FINEC-SQ is a finishing and edge-protection profile for outside corners of tile coverings. This minimalistic wall profile features a symmetrical 3/16" (4.5 mm) profile reveal that combines the slim look of Schluter®-FINEC with the square shape of Schluter®-QUADEC and a perforated anchoring leg that is secured in mortar bond coat beneath the tile. This profile is available in larger sizes to accommodate thicker tiles and is ideal for protecting mitered edges. Available in satin anodized aluminum, as well as color-coated aluminum in all TRENDLINE colors.

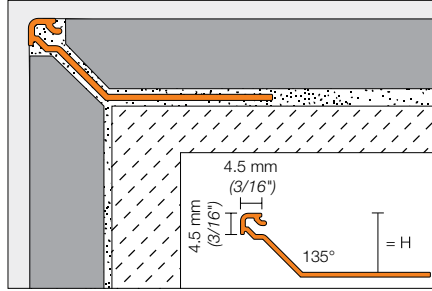

FINEC-SQ can be combined with QUADEC corner pieces

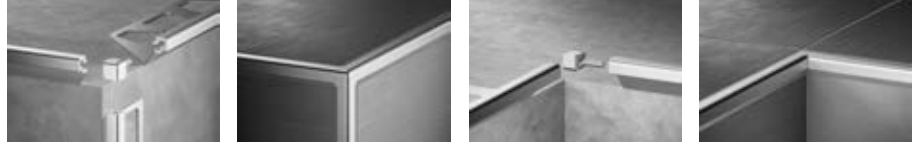

Schluter®-FINEC-SQ				
Length = 2.5 m - 8' 2-1/2"		Satin anodized aluminum (AE)		
H = mm - in.	Profile	\$/ Length	Inside/Outside Corner	\$/ Unit
11 - 7/16	FSQ 110 AE	22.52	EV/Q 45 AE	8.74
12.5 - 1/2	FSQ 125 AE	22.77		
15 - 9/16	FSQ 150 AE	22.83		

Schluter®-FINEC-SQ				
Length = 2.5 m - 8' 2-1/2"		Textured color-coated aluminum		
H = mm - in.	Profile	\$/ Length	Inside/Outside Corner	\$/ Unit
11 - 7/16	FSQ 110 + color*	30.29	EV/Q 45 + color*	16.49
12.5 - 1/2	FSQ 125 + color*	30.37		
15 - 9/16	FSQ 150 + color*	30.47		

Color Codes

TSI Ivory	TSBG Greige	TSSG Stone grey	TSC Cream	TSB Beige	TSR Rustic brown
TSOB Bronze	TSG Pewter	TSLA Light anthracite	TSDA Dark anthracite	MBW Matte white	MGS Matte black

* To complete the item number, add the color code (e.g., FSQ 110 TSC).



Schluter®-FINEC-SQ in matte black



Schluter®-FINEC

Schluter®-FINEC is a finishing and edge-protection profile for the external edges of tile coverings or mosaics. The finishing leg of the profile protects the covering edges from mechanical damage, and features a very slim, elegant reveal. Available in anodized aluminium, color-coated aluminium in all TRENDLINE colors, as well as stainless steel. FINEC is ideal for protecting mitered edges, while creating a discreet trim for a minimalist design.

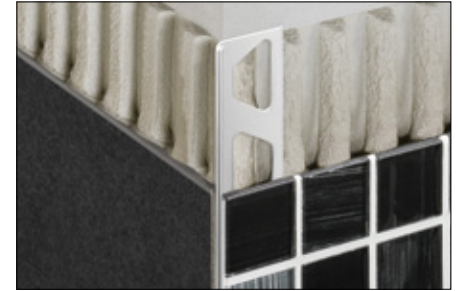
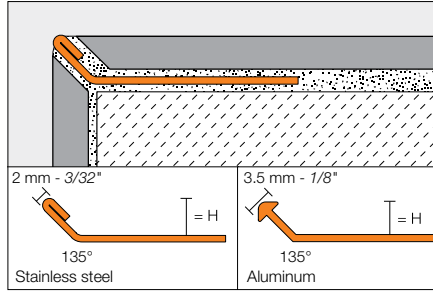

Schluter®-FINEC				
Length = 2.5 m - 8' 2-1/2"	Stainless steel 304 (1.4301 = V2A) (E)		Satin anodized aluminum (AE)	
H = mm - in.	Item No.	\$ / Length	Item No.	\$ / Length
2.5 - 3/32	-	-	F 25 AE	17.20
4.5 - 3/16	F 45 E	33.53	F 45 AE	17.45
7 - 9/32	F 70 E	35.18	F 70 AE	18.15
9 - 11/32	F 90 E	37.49	F 90 AE	19.03
11 - 7/16	F 110 E	38.73	F 110 AE	19.79
12.5 - 1/2	F 125 E	39.45	F 125 AE	20.30

Length = 2.5 m - 8' 2-1/2"	Textured color-coated aluminum		
H = mm - in.	Item No.		\$ / Length
2.5 - 3/32	F 25 MBW		23.86
4.5 - 3/16	F 45 + color*		24.34
7 - 9/32	F 70 + color*		24.85
9 - 11/32	F 90 + color*		25.90
11 - 7/16	F 110 + color*		26.16
12.5 - 1/2	F 125 + color*		26.67

***Color Codes**

TSI Ivory	TSBG Greige	TSSG Stone grey	TSC Cream	TSB Beige	TSR Rustic brown
TSOB Bronze	TSG Pewter	TSLA Light anthracite	TSDA Dark anthracite	MBW Matte white	MGS Matte black

* To complete the item number, add the color code (e.g., F 70 TSC).



· Schluter®-FINEC in stainless steel



Schluter®-INDEC

Schluter®-INDEC is an anodized aluminum profile for outside corners of tiled surfaces and tiled edges. The reveal of the profile forms a square recessed groove for modern decorative design and interesting contrasts.

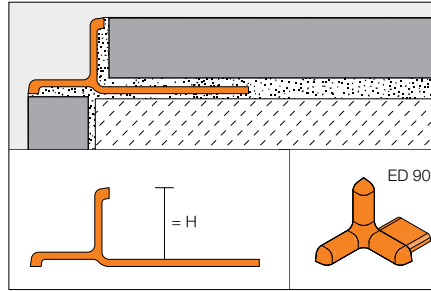

Schluter®-INDEC									
Length = 2.5 m - 8' 2-1/2"		Satin anodized aluminum (AE)		Cast zinc with AE appearance		Polished chrome anod. alu. (ACG)		Cast zinc with ACG appearance	
H = mm - in.		Profile	\$ / Length	Outside corner 90°	\$ / Unit	Profile	\$ / Length	Outside corner 90°	\$ / Unit
8 - 5/16		IN 80 AE	27.49	ED / IN 80 AE	7.44	IN 80 ACG	48.29	ED / IN 80 ACG	7.44
10 - 3/8		IN 100 AE	28.41	ED / IN 100 AE	7.44	IN 100 ACG	49.58	ED / IN 100 ACG	7.44
11 - 7/16		IN 110 AE	29.33	ED / IN 110 AE	7.44	IN 110 ACG	52.57	ED / IN 110 ACG	7.44
12.5 - 1/2		IN 125 AE	34.46	ED / IN 125 AE	7.44	IN 125 ACG	56.08	ED / IN 125 ACG	7.44

Schluter®-DECO-DE

Schluter®-DECO-DE is a stainless steel finishing and edge-protection profile for 135° outside corners of tiled surfaces.

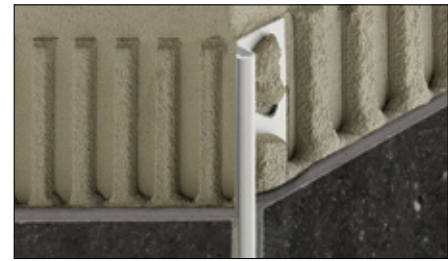
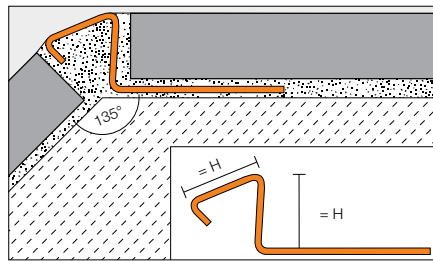

Schluter®-DECO-DE					
Length = 2.5 m - 8' 2-1/2"		Stainless steel 304 (1.4301 = V2A) (E)		Brushed stainless steel 304 (1.4301 = V2A) (EB)	
H = mm - in.		Item No.	\$ / Length	Item No.	\$ / Length
8 - 5/16		DE 80 ES	48.53	DE 80 EBS	53.59
10 - 3/8		DE 100 ES	51.01	DE 100 EBS	56.39
11 - 7/16		DE 110 ES	51.90	DE 110 EBS	57.75
12.5 - 1/2		DE 125 ES	53.35	DE 125 EBS	59.69



Schluter®-RONDEC-DB

Schluter®-RONDEC-DB is a decorative profile for walls, wainscotings, and tile bases. The profile produces a pronounced visible surface that establishes a clean line along tile edges and allows for decorative design. RONDEC-DB can also be used as a finishing profile within wall surfaces. RONDEC-DB features an integrated joint spacer that establishes a defined joint cavity between the tile and the profile.

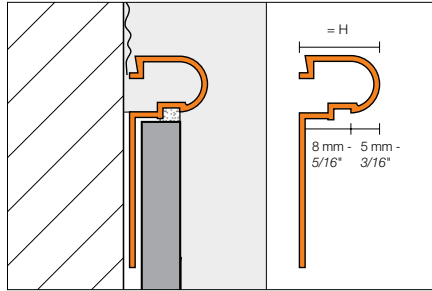

Outside corner (90°)



Schluter®-RONDEC-DB								
Length = 2.5 m - 8' 2-1/2"	Satin anodized aluminum (AE)				Satin copper anod. alu. (AK)		Satin brass anod. alu. (AM)	
H = mm - in.	Profile	\$/ Length	Outside corner, 90°	\$/ Unit	Profile	\$/ Length	Profile	\$/ Length
14 - 17/32	DB 14 AE	33.06	EV/DB 14 AE	12.90	DB 14 AK	34.99	DB 14 AM	33.06

10-foot (3.05 m) RONDEC-DB Profile		
Length = 3.05 m - 10'	Satin anodized aluminum (AE)	
H = mm - in.	Profile	\$/ Length
14 - 17/32	DB 14 AE / 300	41.33

Special shipping conditions apply, see pages 199 - 200.



Schluter®-DESIGNLINE

Schluter®-DESIGNLINE is a border profile for producing decorative designs in tile fields on walls. DESIGNLINE in stainless steel can also be used to produce decorative designs in floors. The profile can be combined with Schluter®-QUADEC (page 37) and Schluter®-RONDEC (page 28) finishing and edge-protection profiles. DESIGNLINE in anodized aluminum features an integrated joint spacer that establishes a defined joint cavity between the tile and the profile.

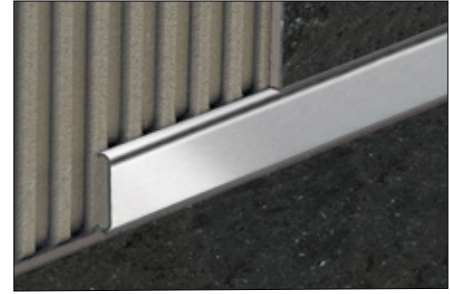
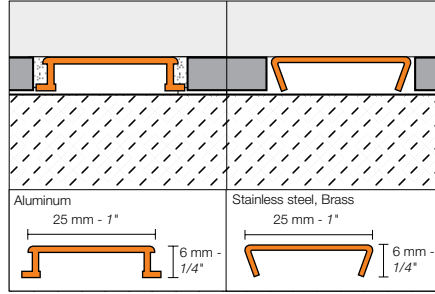

Schluter®-DESIGNLINE						
Length = 2.5 m - 8' 2-1/2"	Stainless steel 304 (1.4301 = V2A) (E)		Brushed stainless steel 304 (1.4301 = V2A) (EB)		Chrome-plated solid brass (MC) *	
H = mm - in.	Item No.	\$ / Length	Item No.	\$ / Length	Item No.	\$ / Length
6 - 1/4	DL 625 E	63.92	DL 625 EB	93.49	DL 625 MC	101.09
Length = 2.5 m - 8' 2-1/2"	Satin anodized aluminum (AE)		Polished chrome anod. alu. (ACG)		Brushed chrome anod. alu. (ACGB)	
H = mm - in.	Item No.	\$ / Length	Item No.	\$ / Length	Item No.	\$ / Length
6 - 1/4	DL 625 AE	27.99	DL 625 ACG	38.53	DL 625 ACGB	44.14
Length = 2.5 m - 8' 2-1/2"	Satin nickel anod. alu. (AT)		Polished nickel anod. alu. (ATG)		Brushed nickel anod. alu. (ATGB)	
H = mm - in.	Item No.	\$ / Length	Item No.	\$ / Length	Item No.	\$ / Length
6 - 1/4	DL 625 AT	29.40	DL 625 ATG	39.90	DL 625 ATGB	45.51
Length = 2.5 m - 8' 2-1/2"	Satin copper anod. alu. (AK)		Polished copper anod. alu. (AKG)		Brushed copper anod. alu. (AKGB)	
H = mm - in.	Item No.	\$ / Length	Item No.	\$ / Length	Item No.	\$ / Length
6 - 1/4	DL 625 AK	29.40	DL 625 AKG	39.90	DL 625 AKGB	45.51
Length = 2.5 m - 8' 2-1/2"	Satin brass anod. alu. (AM)		Polished brass anod. alu. (AMG)		Brushed brass anod. alu. (AMGB)	
H = mm - in.	Item No.	\$ / Length	Item No.	\$ / Length	Item No.	\$ / Length
6 - 1/4	DL 625 AM	27.99	DL 625 AMG	38.53	DL 625 AMGB	44.14

* ⚠ **WARNING:** Reproductive Harm - www.P65Warnings.ca.gov



Schluter®-DECO-SG

Schluter®-DECO-SG is a decorative profile featuring a 1/2" (12.5 mm) or 9/16" (15 mm) -wide channel that creates a shadow gap between tile courses or other wall covering. The profile may also be used as a support channel for glass panels. The 1/2" (12.5 mm) wide channel accommodates glass panels up to a thickness of 3/8" (10 mm), and the 9/16" (15 mm) wide channel accommodates glass panels up to a thickness of 1/2" (12.5 mm). DECO-SG features a trapezoid-perforated anchoring leg that is secured in the bond coat beneath the tile.

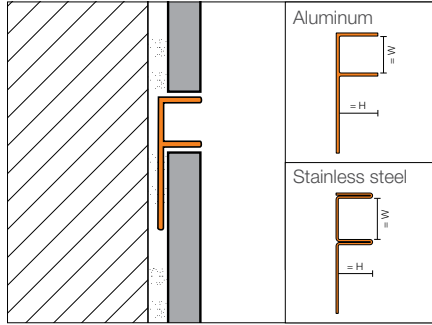

Schluter®-DECO-SG						
Length = 2.5 m - 8' 2-1/2"	Brushed stainless steel 304 (1.4301 = V2A) (EB)		Satin anodized aluminum (AE)		Bright chrome anodized aluminum (ACB)	
H = mm - in.	Item No.	\$ / Length	Item No.	\$ / Length	Item No.	\$ / Length
W: 12.5 mm - 1/2"						
8 - 5/16	SG 80 EB 12	79.98	SG 80 AE 12	22.09	SG 80 ACB 12	22.98
10 - 3/8	SG 100 EB 12	85.42	SG 100 AE 12	23.23	SG 100 ACB 12	24.06
11 - 7/16	SG 110 EB 12	88.36	SG 110 AE 12	23.86	SG 110 ACB 12	24.75
12.5 - 1/2	SG 125 EB 12	93.04	SG 125 AE 12	24.67	SG 125 ACB 12	25.56
W: 15 mm - 9/16"						
8 - 5/16	SG 80 EB 15	82.47	SG 80 AE 15	23.19	SG 80 ACB 15	24.12
10 - 3/8	SG 100 EB 15	87.85	SG 100 AE 15	24.40	SG 100 ACB 15	25.27
11 - 7/16	SG 110 EB 15	91.13	SG 110 AE 15	25.05	SG 110 ACB 15	25.99
12.5 - 1/2	SG 125 EB 15	94.59	SG 125 AE 15	25.91	SG 125 ACB 15	26.86

NEW! Schluter®-TRENDLINE Textured Color-coated Aluminum

Length = 2.5 m - 8' 2-1/2"	▲ Textured color-coated aluminum	
H = mm - in.	Item No.	\$ / Length
W: 12.5 mm - 1/2"		
8 - 5/16	SG 80 + color* 12	42.94
10 - 3/8	SG 100 + color* 12	44.10
11 - 7/16	SG 110 + color* 12	44.71
12.5 - 1/2	SG 125 + color* 12	45.14
W: 15 mm - 9/16"		
8 - 5/16	SG 80 + color* 15	44.99
10 - 3/8	SG 100 + color* 15	46.15
11 - 7/16	SG 110 + color* 15	46.76
12.5 - 1/2	SG 125 + color* 15	47.19

*Color Codes										
TSI	TSBG	TSSG	TSC	TSOB	TSG	TSDA	MBW	MGS		
Ivory	Greige	Stone grey	Cream	Bronze	Pewter	Dark anthracite	Matte white	Matte black		
* To complete the item number, add the color code (e.g., SG 80 TSI 12).										



Schluter®-DECO-SGC

Schluter®-DECO-SGC is a decorative profile featuring a 1/2" (12.5 mm) or 9/16" (15 mm) -wide channel used as a vertical support for glass panels in recessed showers that border on untiled walls that are plastered, creating a 90° angle between the glass partition and the untiled wall. The 1/2" (12.5 mm) wide channel accommodates glass panels up to a thickness of 3/8" (10 mm), and the 9/16" (15 mm) wide channel accommodates glass panels up to a thickness of 1/2" (12.5 mm). DECO-SGC features a trapezoid-perforated anchoring leg that is secured in the bond coat beneath the tile.

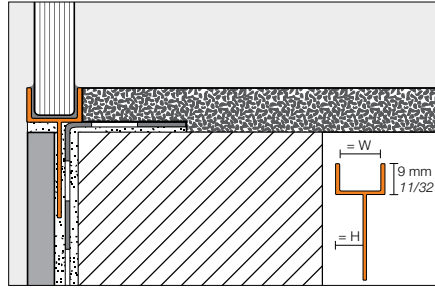

Schluter®-DECO-SGC		
Length = 2.5 m - 8' 2-1/2"	Satin anodized aluminum (AE)	
H = mm - in.	Item No.	\$ / Length
W: 12.5 mm - 1/2"		
8 - 5/16	SGC 80 AE 12	23.86
10 - 3/8	SGC 100 AE 12	25.09
11 - 7/16	SGC 110 AE 12	25.77
12.5 - 1/2	SGC 125 AE 12	26.65
W: 15 mm - 9/16"		
8 - 5/16	SGC 80 AE 15	25.04
10 - 3/8	SGC 100 AE 15	26.35
11 - 7/16	SGC 110 AE 15	27.05
12.5 - 1/2	SGC 125 AE 15	27.99





Schluter®-RONDEC-STEP

Schluter®-RONDEC-STEP is a finishing and edging profile for ceramic tile and dimension stone installations on countertops and stairs. The top of the profile features a symmetrically rounded edge that matches the Schluter®-RONDEC profile (page 28), while the vertical leg of the profile hides the exposed edge of the sub-assembly. RONDEC-STEP features an integrated joint spacer that establishes a defined joint cavity between the tile and the profile.

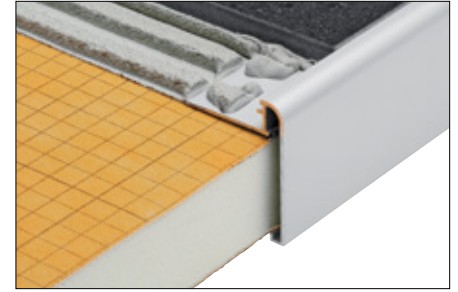
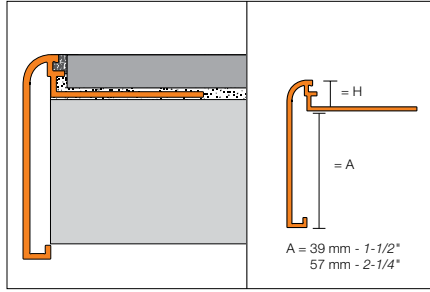

Outside corner (90° or 135°)



Inside corner (90° or 135°)



Schluter®-RONDEC-STEP								
Length = 2.5 m - 8' 2-1/2"	Satin anodized aluminum (AE)							
H = mm - in.	Profile	\$/ Length	Outside corner, 90°	Outside corner, 135°	Inside corner, 90°	Inside corner, 135°	\$/ Unit	
A: 39 mm - 1-1/2"								
8 - 5/16	RS 80 AE 39	47.18	E90 RS 80 AE 39	E135 RS 80 AE 39	I90 RS 80 AE 39	I135 RS 80 AE 39	22.01	
10 - 3/8	RS 100 AE 39	47.95	E90 RS 100 AE 39	E135 RS 100 AE 39	I90 RS 100 AE 39	I135 RS 100 AE 39	22.01	
12.5 - 1/2	RS 125 AE 39	49.58	E90 RS 125 AE 39	E135 RS 125 AE 39	I90 RS 125 AE 39	I135 RS 125 AE 39	22.01	
A: 57 mm - 2-1/4"								
8 - 5/16	RS 80 AE 57	48.40	E90 RS 80 AE 57	E135 RS 80 AE 57	I90 RS 80 AE 57	I135 RS 80 AE 57	22.01	
10 - 3/8	RS 100 AE 57	49.18	E90 RS 100 AE 57	E135 RS 100 AE 57	I90 RS 100 AE 57	I135 RS 100 AE 57	22.01	
12.5 - 1/2	RS 125 AE 57	51.46	E90 RS 125 AE 57	E135 RS 125 AE 57	I90 RS 125 AE 57	I135 RS 125 AE 57	22.01	

Length = 2.5 m - 8' 2-1/2"	Brushed chrome anodized aluminum (ACGB)							
H = mm - in.	Profile	\$/ Length	Outside corner, 90°	Outside corner, 135°	Inside corner, 90°	Inside corner, 135°	\$/ Unit	
A: 39 mm - 1-1/2"								
8 - 5/16	RS 80 ACGB 39	61.77	E90 RS 80 ACGB 39	E135 RS 80 ACGB 39	I90 RS 80 ACGB 39	I135 RS 80 ACGB 39	24.85	
10 - 3/8	RS 100 ACGB 39	62.46	E90 RS 100 ACGB 39	E135 RS 100 ACGB 39	I90 RS 100 ACGB 39	I135 RS 100 ACGB 39	24.85	
12.5 - 1/2	RS 125 ACGB 39	64.61	E90 RS 125 ACGB 39	E135 RS 125 ACGB 39	I90 RS 125 ACGB 39	I135 RS 125 ACGB 39	24.85	
A: 57 mm - 2-1/4"								
8 - 5/16	RS 80 ACGB 57	62.91	E90 RS 80 ACGB 57	E135 RS 80 ACGB 57	I90 RS 80 ACGB 57	I135 RS 80 ACGB 57	24.85	
10 - 3/8	RS 100 ACGB 57	63.62	E90 RS 100 ACGB 57	E135 RS 100 ACGB 57	I90 RS 100 ACGB 57	I135 RS 100 ACGB 57	24.85	
12.5 - 1/2	RS 125 ACGB 57	65.74	E90 RS 125 ACGB 57	E135 RS 125 ACGB 57	I90 RS 125 ACGB 57	I135 RS 125 ACGB 57	24.85	

Length = 2.5 m - 8' 2-1/2"	Satin nickel anodized aluminum (AT)							
H = mm - in.	Profile	\$/ Length	Outside corner, 90°	Outside corner, 135°	Inside corner, 90°	Inside corner, 135°	\$/ Unit	
A: 39 mm - 1-1/2"								
8 - 5/16	RS 80 AT 39	47.18	E90 RS 80 AT 39	E135 RS 80 AT 39	I90 RS 80 AT 39	I135 RS 80 AT 39	22.01	
10 - 3/8	RS 100 AT 39	47.95	E90 RS 100 AT 39	E135 RS 100 AT 39	I90 RS 100 AT 39	I135 RS 100 AT 39	22.01	
12.5 - 1/2	RS 125 AT 39	49.58	E90 RS 125 AT 39	E135 RS 125 AT 39	I90 RS 125 AT 39	I135 RS 125 AT 39	22.01	
A: 57 mm - 2-1/4"								
8 - 5/16	RS 80 AT 57	48.40	E90 RS 80 AT 57	E135 RS 80 AT 57	I90 RS 80 AT 57	I135 RS 80 AT 57	22.01	
10 - 3/8	RS 100 AT 57	49.18	E90 RS 100 AT 57	E135 RS 100 AT 57	I90 RS 100 AT 57	I135 RS 100 AT 57	22.01	
12.5 - 1/2	RS 125 AT 57	51.46	E90 RS 125 AT 57	E135 RS 125 AT 57	I90 RS 125 AT 57	I135 RS 125 AT 57	22.01	



Schluter®-RONDEC-STEP							
Length = 2.5 m - 8' 2-1/2"	Brushed nickel anodized aluminum (ATGB)						
H = mm - in.	Profile	\$ / Length	Outside corner, 90°	Outside corner, 135°	Inside corner, 90°	Inside corner, 135°	\$ / Unit
A: 39 mm - 1-1/2"							
8 - 5/16	RS 80 ATGB 39	61.77	E90 RS 80 ATGB 39	E135 RS 80 ATGB 39	I90 RS 80 ATGB 39	I135 RS 80 ATGB 39	24.85
10 - 3/8	RS 100 ATGB 39	62.46	E90 RS 100 ATGB 39	E135 RS 100 ATGB 39	I90 RS 100 ATGB 39	I135 RS 100 ATGB 39	24.85
12.5 - 1/2	RS 125 ATGB 39	64.61	E90 RS 125 ATGB 39	E135 RS 125 ATGB 39	I90 RS 125 ATGB 39	I135 RS 125 ATGB 39	24.85

Length = 2.5 m - 8' 2-1/2"	Satin copper anodized aluminum (AK)						
H = mm - in.	Profile	\$ / Length	Outside corner, 90°	Outside corner, 135°	Inside corner, 90°	Inside corner, 135°	\$ / Unit
A: 39 mm - 1-1/2"							
8 - 5/16	RS 80 AK 39	47.18	E90 RS 80 AK 39	E135 RS 80 AK 39	I90 RS 80 AK 39	I135 RS 80 AK 39	22.01
10 - 3/8	RS 100 AK 39	47.95	E90 RS 100 AK 39	E135 RS 100 AK 39	I90 RS 100 AK 39	I135 RS 100 AK 39	22.01
12.5 - 1/2	RS 125 AK 39	49.58	E90 RS 125 AK 39	E135 RS 125 AK 39	I90 RS 125 AK 39	I135 RS 125 AK 39	22.01
A: 57 mm - 2-1/4"							
8 - 5/16	RS 80 AK 57	48.40	E90 RS 80 AK 57	E135 RS 80 AK 57	I90 RS 80 AK 57	I135 RS 80 AK 57	22.01
10 - 3/8	RS 100 AK 57	49.18	E90 RS 100 AK 57	E135 RS 100 AK 57	I90 RS 100 AK 57	I135 RS 100 AK 57	22.01
12.5 - 1/2	RS 125 AK 57	51.46	E90 RS 125 AK 57	E135 RS 125 AK 57	I90 RS 125 AK 57	I135 RS 125 AK 57	22.01

Length = 2.5 m - 8' 2-1/2"	Brushed copper anodized aluminum (AKGB)						
H = mm - in.	Profile	\$ / Length	Outside corner, 90°	Outside corner, 135°	Inside corner, 90°	Inside corner, 135°	\$ / Unit
A: 39 mm - 1-1/2"							
8 - 5/16	RS 80 AKGB 39	61.77	E90 RS 80 AKGB 39	E135 RS 80 AKGB 39	I90 RS 80 AKGB 39	I135 RS 80 AKGB 39	24.85
10 - 3/8	RS 100 AKGB 39	62.46	E90 RS 100 AKGB 39	E135 RS 100 AKGB 39	I90 RS 100 AKGB 39	I135 RS 100 AKGB 39	24.85
12.5 - 1/2	RS 125 AKGB 39	64.61	E90 RS 125 AKGB 39	E135 RS 125 AKGB 39	I90 RS 125 AKGB 39	I135 RS 125 AKGB 39	24.85
A: 57 mm - 2-1/4"							
8 - 5/16	RS 80 AKGB 57	62.91	E90 RS 80 AKGB 57	E135 RS 80 AKGB 57	I90 RS 80 AKGB 57	I135 RS 80 AKGB 57	24.85
10 - 3/8	RS 100 AKGB 57	63.62	E90 RS 100 AKGB 57	E135 RS 100 AKGB 57	I90 RS 100 AKGB 57	I135 RS 100 AKGB 57	24.85
12.5 - 1/2	RS 125 AKGB 57	65.74	E90 RS 125 AKGB 57	E135 RS 125 AKGB 57	I90 RS 125 AKGB 57	I135 RS 125 AKGB 57	24.85

Length = 2.5 m - 8' 2-1/2"	Satin brass anodized aluminum (AM)						
H = mm - in.	Profile	\$ / Length	Outside corner, 90°	Outside corner, 135°	Inside corner, 90°	Inside corner, 135°	\$ / Unit
A: 57 mm - 2-1/4"							
8 - 5/16	RS 80 AM 57	48.40	E90 RS 80 AM 57	E135 RS 80 AM 57	I90 RS 80 AM 57	I135 RS 80 AM 57	22.01
10 - 3/8	RS 100 AM 57	49.18	E90 RS 100 AM 57	E135 RS 100 AM 57	I90 RS 100 AM 57	I135 RS 100 AM 57	22.01
12.5 - 1/2	RS 125 AM 57	51.46	E90 RS 125 AM 57	E135 RS 125 AM 57	I90 RS 125 AM 57	I135 RS 125 AM 57	22.01

Length = 2.5 m - 8' 2-1/2"	Brushed brass anodized aluminum (AMGB)						
H = mm - in.	Profile	\$ / Length	Outside corner, 90°	Outside corner, 135°	Inside corner, 90°	Inside corner, 135°	\$ / Unit
A: 39 mm - 1-1/2"							
8 - 5/16	RS 80 AMGB 39	61.77	E90 RS 80 AMGB 39	E135 RS 80 AMGB 39	I90 RS 80 AMGB 39	I135 RS 80 AMGB 39	24.85
10 - 3/8	RS 100 AMGB 39	62.46	E90 RS 100 AMGB 39	E135 RS 100 AMGB 39	I90 RS 100 AMGB 39	I135 RS 100 AMGB 39	24.85
12.5 - 1/2	RS 125 AMGB 39	64.61	E90 RS 125 AMGB 39	E135 RS 125 AMGB 39	I90 RS 125 AMGB 39	I135 RS 125 AMGB 39	24.85
A: 57 mm - 2-1/4"							
8 - 5/16	RS 80 AMGB 57	62.91	E90 RS 80 AMGB 57	E135 RS 80 AMGB 57	I90 RS 80 AMGB 57	I135 RS 80 AMGB 57	24.85
10 - 3/8	RS 100 AMGB 57	63.62	E90 RS 100 AMGB 57	E135 RS 100 AMGB 57	I90 RS 100 AMGB 57	I135 RS 100 AMGB 57	24.85
12.5 - 1/2	RS 125 AMGB 57	65.74	E90 RS 125 AMGB 57	E135 RS 125 AMGB 57	I90 RS 125 AMGB 57	I135 RS 125 AMGB 57	24.85



Schluter®-RONDEC-STEP							
Length = 2.5 m - 8' 2-1/2"	Brushed antique bronze anodized aluminum (ABGB)						
H = mm - in.	Profile	\$ / Length	Outside corner, 90°	Outside corner, 135°	Inside corner, 90°	Inside corner, 135°	\$ / Unit
A: 39 mm - 1-1/2"							
8 - 5/16	RS 80 ABGB 39	61.77	E90 RS 80 ABGB 39	E135 RS 80 ABGB 39	I90 RS 80 ABGB 39	I135 RS 80 ABGB 39	24.85
10 - 3/8	RS 100 ABGB 39	62.46	E90 RS 100 ABGB 39	E135 RS 100 ABGB 39	I90 RS 100 ABGB 39	I135 RS 100 ABGB 39	24.85
12.5 - 1/2	RS 125 ABGB 39	64.61	E90 RS 125 ABGB 39	E135 RS 125 ABGB 39	I90 RS 125 ABGB 39	I135 RS 125 ABGB 39	24.85

Schluter®-RONDEC-CT

Schluter®-RONDEC-CT is a double-rail edging profile for countertops to be fitted with a ceramic or dimension stone tile covering. The face of the profile features a recessed section to which field or accent tile is bonded. The top and bottom edges of the profile are symmetrically rounded and match the Schluter®-RONDEC profile (page 28). RONDEC-CT features an integrated joint spacer that establishes a defined joint cavity between the tile and the profile.

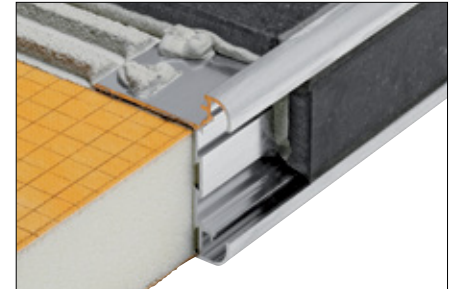
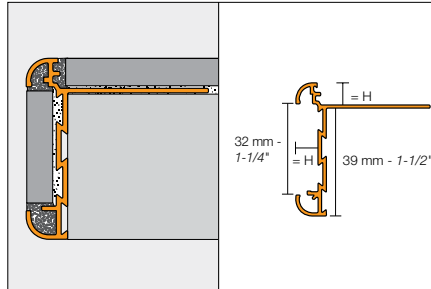

Outside corner (90° or 135°)

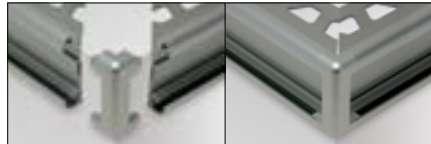

Inside corner (90° or 135°)



Schluter®-RONDEC-CT							
Length = 2.5 m - 8' 2-1/2"	Satin anodized aluminum (AE)						
H = mm - in.	Profile	\$ / Length	Outside corner, 90°	Outside corner, 135°	Inside corner, 90°	Inside corner, 135°	\$ / Unit
8 - 5/16	RC 80 AE 39	52.22	E90 RC 80 AE 39	E135 RC 80 AE 39	I90 RC 80 AE 39	I135 RC 80 AE 39	27.39
10 - 3/8	RC 100 AE 39	53.12	E90 RC 100 AE 39	E135 RC 100 AE 39	I90 RC 100 AE 39	I135 RC 100 AE 39	27.39
12.5 - 1/2	RC 125 AE 39	55.56	E90 RC 125 AE 39	E135 RC 125 AE 39	I90 RC 125 AE 39	I135 RC 125 AE 39	27.39

Schluter®-RONDEC-CT							
Length = 2.5 m - 8' 2-1/2"	Brushed chrome anodized aluminum (ACGB)						
H = mm - in.	Profile	\$ / Length	Outside corner, 90°	Outside corner, 135°	Inside corner, 90°	Inside corner, 135°	\$ / Unit
8 - 5/16	RC 80 ACGB 39	59.35	E90 RC 80 ACGB 39	E135 RC 80 ACGB 39	I90 RC 80 ACGB 39	I135 RC 80 ACGB 39	31.55
10 - 3/8	RC 100 ACGB 39	59.68	E90 RC 100 ACGB 39	E135 RC 100 ACGB 39	I90 RC 100 ACGB 39	I135 RC 100 ACGB 39	31.55
12.5 - 1/2	RC 125 ACGB 39	61.76	E90 RC 125 ACGB 39	E135 RC 125 ACGB 39	I90 RC 125 ACGB 39	I135 RC 125 ACGB 39	31.55

Schluter®-RONDEC-CT							
Length = 2.5 m - 8' 2-1/2"	Satin nickel anodized aluminum (AT)						
H = mm - in.	Profile	\$ / Length	Outside corner, 90°	Outside corner, 135°	Inside corner, 90°	Inside corner, 135°	\$ / Unit
8 - 5/16	RC 80 AT 39	57.21	E90 RC 80 AT 39	E135 RC 80 AT 39	I90 RC 80 AT 39	I135 RC 80 AT 39	27.39
10 - 3/8	RC 100 AT 39	58.47	E90 RC 100 AT 39	E135 RC 100 AT 39	I90 RC 100 AT 39	I135 RC 100 AT 39	27.39
12.5 - 1/2	RC 125 AT 39	60.92	E90 RC 125 AT 39	E135 RC 125 AT 39	I90 RC 125 AT 39	I135 RC 125 AT 39	27.39



Schluter®-RONDEC-CT							
Length = 2.5 m - 8' 2-1/2"	Brushed nickel anodized aluminum (ATGB)						
H = mm - in.	Profile	\$ / Length	Outside corner, 90°	Outside corner, 135°	Inside corner, 90°	Inside corner, 135°	\$ / Unit
8 - 5/16	RC 80 ATGB 39	62.17	E90 RC 80 ATGB 39	E135 RC 80 ATGB 39	I90 RC 80 ATGB 39	I135 RC 80 ATGB 39	31.55
10 - 3/8	RC 100 ATGB 39	63.37	E90 RC 100 ATGB 39	E135 RC 100 ATGB 39	I90 RC 100 ATGB 39	I135 RC 100 ATGB 39	31.55
12.5 - 1/2	RC 125 ATGB 39	63.81	E90 RC 125 ATGB 39	E135 RC 125 ATGB 39	I90 RC 125 ATGB 39	I135 RC 125 ATGB 39	31.55

Length = 2.5 m - 8' 2-1/2"	Satin copper anodized aluminum (AK)						
H = mm - in.	Profile	\$ / Length	Outside corner, 90°	Outside corner, 135°	Inside corner, 90°	Inside corner, 135°	\$ / Unit
8 - 5/16	RC 80 AK 39	57.21	E90 RC 80 AK 39	E135 RC 80 AK 39	I90 RC 80 AK 39	I135 RC 80 AK 39	27.39
10 - 3/8	RC 100 AK 39	58.47	E90 RC 100 AK 39	E135 RC 100 AK 39	I90 RC 100 AK 39	I135 RC 100 AK 39	27.39
12.5 - 1/2	RC 125 AK 39	60.92	E90 RC 125 AK 39	E135 RC 125 AK 39	I90 RC 125 AK 39	I135 RC 125 AK 39	27.39

Length = 2.5 m - 8' 2-1/2"	Brushed copper anodized aluminum (AKGB)						
H = mm - in.	Profile	\$ / Length	Outside corner, 90°	Outside corner, 135°	Inside corner, 90°	Inside corner, 135°	\$ / Unit
8 - 5/16	RC 80 AKGB 39	62.17	E90 RC 80 AKGB 39	E135 RC 80 AKGB 39	I90 RC 80 AKGB 39	I135 RC 80 AKGB 39	31.55
10 - 3/8	RC 100 AKGB 39	63.37	E90 RC 100 AKGB 39	E135 RC 100 AKGB 39	I90 RC 100 AKGB 39	I135 RC 100 AKGB 39	31.55
12.5 - 1/2	RC 125 AKGB 39	63.81	E90 RC 125 AKGB 39	E135 RC 125 AKGB 39	I90 RC 125 AKGB 39	I135 RC 125 AKGB 39	31.55

Length = 2.5 m - 8' 2-1/2"	Satin brass anodized aluminum (AM)						
H = mm - in.	Profile	\$ / Length	Outside corner, 90°	Outside corner, 135°	Inside corner, 90°	Inside corner, 135°	\$ / Unit
8 - 5/16	RC 80 AM 39	53.89	E90 RC 80 AM 39	E135 RC 80 AM 39	I90 RC 80 AM 39	I135 RC 80 AM 39	27.39
10 - 3/8	RC 100 AM 39	55.18	E90 RC 100 AM 39	E135 RC 100 AM 39	I90 RC 100 AM 39	I135 RC 100 AM 39	27.39
12.5 - 1/2	RC 125 AM 39	57.62	E90 RC 125 AM 39	E135 RC 125 AM 39	I90 RC 125 AM 39	I135 RC 125 AM 39	27.39

Length = 2.5 m - 8' 2-1/2"	Brushed brass anodized aluminum (AMGB)						
H = mm - in.	Profile	\$ / Length	Outside corner, 90°	Outside corner, 135°	Inside corner, 90°	Inside corner, 135°	\$ / Unit
8 - 5/16	RC 80 AMGB 39	59.35	E90 RC 80 AMGB 39	E135 RC 80 AMGB 39	I90 RC 80 AMGB 39	I135 RC 80 AMGB 39	31.55
10 - 3/8	RC 100 AMGB 39	59.68	E90 RC 100 AMGB 39	E135 RC 100 AMGB 39	I90 RC 100 AMGB 39	I135 RC 100 AMGB 39	31.55
12.5 - 1/2	RC 125 AMGB 39	61.76	E90 RC 125 AMGB 39	E135 RC 125 AMGB 39	I90 RC 125 AMGB 39	I135 RC 125 AMGB 39	31.55

Schluter®-TRENDLINE Textured Color-coated Aluminum

Length = 2.5 m - 8' 2-1/2"	Textured color-coated aluminum (TS)	
H = mm - in.	Profile	\$ / Length
8 - 5/16	RC 80 + color* 39	77.60
10 - 3/8	RC 100 + color* 39	81.81
12.5 - 1/2	RC 125 + color* 39	83.80

***Color Codes**



TSB
Beige



TSOB
Bronze



TSG
Pewter

* To complete the item number, add the color code (e.g., RC 80 **TSB** 39).

Length = 2.5 m - 8' 2-1/2"	Textured color-coated aluminum (TS)				
H = mm - in.	Outside corner, 90°	Outside corner, 135°	Inside corner, 90°	Inside corner, 135°	\$ / Unit
8 - 5/16	E90 RC 80 + color* 39	E135 RC 80 + color* 39	I90 RC 80 + color* 39	I135 RC 80 + color* 39	33.13
10 - 3/8	E90 RC 100 + color* 39	E135 RC 100 + color* 39	I90 RC 100 + color* 39	I135 RC 100 + color* 39	33.13
12.5 - 1/2	E90 RC 125 + color* 39	E135 RC 125 + color* 39	I90 RC 125 + color* 39	I135 RC 125 + color* 39	33.13



Schluter®-SCHIENE-STEP

Schluter®-SCHIENE-STEP is a finishing and edging profile for ceramic tile and natural stone installations on countertops, stairs, and tile over tile applications on walls. The top of the profile features a vertical wall section that finishes and protects the tile from damage, while the vertical leg covers the edge of the sub-assembly, top of the riser, or existing wall tile edge.

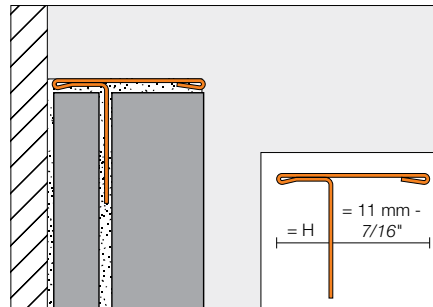
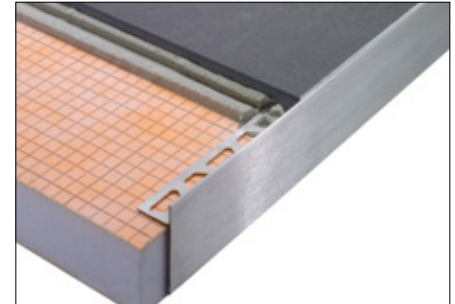
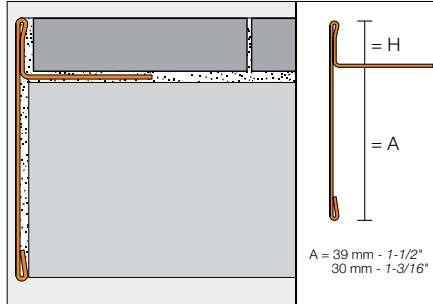

Schluter®-SCHIENE-STEP							
Length = 2.5 m - 8' 2-1/2"	Brushed Stainless Steel 304 (1.4301 = V2A) (EB)						
H = mm - in.	Profile	\$ / Length	Inside corner, 90°	Inside corner, 135°	Outside corner, 90° and End Cap	Outside corner, 135°	\$ / Unit
A: 39 mm - 1-1/2"							
6 - 1/4	SS 60 EB 39	143.10	I90 / SS 60 EB 39	I135 / SS 60 EB 39	E90 / SS 60 EB 39	E135 / SS 60 EB 39	18.90
9 - 11/32	SS 90 EB 39	149.04	I90 / SS 90 EB 39	I135 / SS 90 EB 39	E90 / SS 90 EB 39	E135 / SS 90 EB 39	18.90
11 - 7/16	SS 110 EB 39	151.73	I90 / SS 110 EB 39	I135 / SS 110 EB 39	E90 / SS 110 EB 39	E135 / SS 110 EB 39	18.90
12.5 - 1/2	SS 125 EB 39	154.12	I90 / SS 125 EB 39	I135 / SS 125 EB 39	E90 / SS 125 EB 39	E135 / SS 125 EB 39	18.90
A: 30 mm - 1-3/16"							
9 - 11/32	SS 90 EB 30	112.69	-	-	E90 / SS 90 EB 30	-	18.90
11 - 7/16	SS 110 EB 30	114.13	-	-	E90 / SS 110 EB 30	-	18.90
12.5 - 1/2	SS 125 EB 30	115.58	-	-	E90 / SS 125 EB 30	-	18.90
A: 11 mm - 7/16"							
6 - 1/4	SS 60 EB 11	108.41					
12.5 - 1/2	SS 125 EB 11	109.81					

Brushed Stainless Steel 304 (1.4301 = V2A) (EB)		
H = mm - in.	Connector	\$ / Unit
A: 39 mm - 1-1/2"		
6 - 1/4	V / SS 60 EB 39	16.07
9 - 11/32	V / SS 90 EB 39	16.07
11 - 7/16	V / SS 110 EB 39	16.07
12.5 - 1/2	V / SS 125 EB 39	16.07
A: 30 mm - 1-3/16"		
9 - 11/32	V / SS 90 EB 30	16.07
11 - 7/16	V / SS 110 EB 30	16.07
12.5 - 1/2	V / SS 125 EB 30	16.07
A: 11 mm - 7/16"		
6 - 1/4	V / SS 60 EB 11	16.07
12.5 - 1/2	V / SS 125 EB 11	16.07

Note: The anchoring leg of **Schluter®-SCHIENE-STEP** is available with a special radius perforation so that the profile can be used to form curves.

- Price surcharge: \$0.70 per foot
- Item No.: R / Profile No. (e.g., R/SS 60 EB 11)
- For delivery time, please call Customer Service





Schluter®-ECK-E

Schluter®-ECK-E is a stainless steel edging profile for outside corners of tiled walls that offers excellent edge protection against mechanical stresses in commercial/industrial applications. The profile produces a radiused edge along the outside wall corner for a clean, decorative finish. ECK-E is installed simultaneously with the tile, while ECK-K (page 55) is subsequently installed on the outside corners of existing installations.

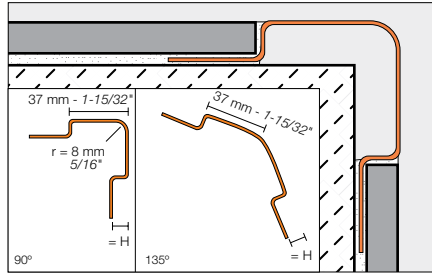

Note: ECK-E is also available in stainless steel 316L (1.4404 = V4A). Contact Customer Service for price and availability.

Schluter®-ECK-E				
H = mm - in.	Stainless steel 304 (1.4301 = V2A) (E)		Brushed stainless steel 304 (1.4301 = V2A) (EB)	
	Item No.	\$ / Length	Item No.	\$ / Length
90° Angle				
Length = 1.50 m - 4' 11"				
6 - 1/4	E37 V2A 60/150	61.89	E37 V2A EB 60/150	80.44
8 - 5/16	E37 V2A 80/150	64.36	E37 V2A EB 80/150	83.66
11 - 7/16	E37 V2A 110/150	66.93	E37 V2A EB 110/150	86.99
Length = 2.00 m - 6' 7"				
6 - 1/4	E37 V2A 60/200	79.50	E37 V2A EB 60/200	103.38
8 - 5/16	E37 V2A 80/200	82.66	E37 V2A EB 80/200	107.50
11 - 7/16	E37 V2A 110/200	86.08	E37 V2A EB 110/200	111.92
Length = 2.5 m - 8' 2-1/2"				
6 - 1/4	E37 V2A 60/250	97.12	E37 V2A EB 60/250	126.24
8 - 5/16	E37 V2A 80/250	101.01	E37 V2A EB 80/250	131.30
11 - 7/16	E37 V2A 110/250	105.28	E37 V2A EB 110/250	136.86
Length = 3.00 m - 9' 10"				
6 - 1/4	E37 V2A 60/300	120.00	E37 V2A EB 60/300	156.04
8 - 5/16	E37 V2A 80/300	126.61	E37 V2A EB 80/300	164.60
11 - 7/16	E37 V2A 110/300	131.01	E37 V2A EB 110/300	170.36
135° Angle				
Length = 2.5 m - 8' 2-1/2"				
6 - 1/4	E37 E 60S	93.17	E37 EB 60S	121.33
8 - 5/16	E37 E 80S	96.58	E37 EB 80S	125.68
11 - 7/16	E37 E 110S	100.49	E37 EB 110S	130.66
Length = 3.00 m - 9' 10"				
6 - 1/4	E37 E 60S/300	111.74	E37 EB 60S/300	145.52
8 - 5/16	E37 E 80S/300	115.85	E37 EB 80S/300	150.80
11 - 7/16	E37 E 110S/300	120.58	E37 EB 110S/300	156.78



Schluter®-ECK-K

Schluter®-ECK-K is a stainless steel edging profile for outside corners of tiled walls that offers excellent edge protection against mechanical stresses in commercial/ industrial applications. The profile produces a radiused edge along the outside wall corner for a clean, decorative finish. ECK-K is subsequently bonded to the outside corners of existing installations. As such, ECK-K can be installed as a repair so that existing, damaged corners do not have to be replaced.

Note: ECK-K is also available in stainless steel 316L (1.4404 = V4A). Contact Customer Service for price and availability.

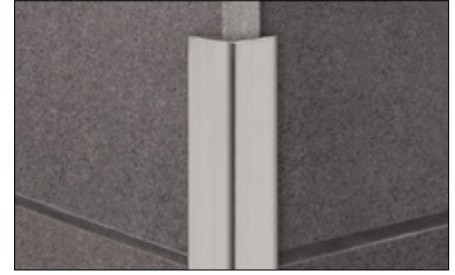
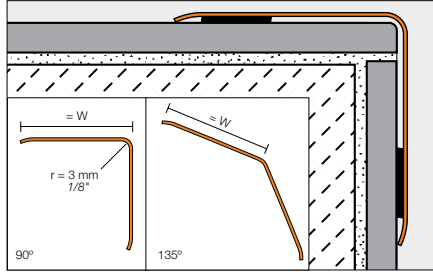

Schluter®-ECK-K				
W = mm - in.	Stainless steel 304 (1.4301 = V2A) (E)		Brushed stainless steel 304 (1.4301 = V2A) (EB)	
	Item No.	\$ / Length	Item No.	\$ / Length
90° Angle				
Length = 1.50 m - 4' 11"				
15 - 9/16	K15 V2A/150	36.58	K15 V2A EB/150	47.57
32 - 1-9/32	K32 V2A/150	60.18	K32 V2A EB/150	78.27
50 - 2	K50 V2A/150	77.44	K50 V2A EB/150	100.72
Length = 2.00 m - 6' 7"				
32 - 1-9/32	K32 V2A/200	80.36	K32 V2A EB/200	104.42
50 - 2	K50 V2A/200	103.26	K50 V2A EB/200	134.23
Length = 2.5 m - 8' 2-1/2"				
15 - 9/16	K15 V2A/250	60.92	K15 V2A EB/250	79.29
32 - 1-9/32	K32 V2A/250	100.35	K32 V2A EB/250	130.49
50 - 2	K50 V2A/250	129.07	K50 V2A EB/250	167.75
Length = 3.00 m - 9' 10"				
15 - 9/16	K15 V2A/300	73.10	K15 V2A EB/300	95.02
32 - 1-9/32	K32 V2A/300	121.83	K32 V2A EB/300	158.32
50 - 2	K50 V2A/300	154.03	K50 V2A EB/300	200.22
135° Angle				
Length = 1.50 m - 4' 11"				
32 - 1-9/32	K32 ES/150	58.43		
Length = 2.5 m - 8' 2-1/2"				
32 - 1-9/32	K32 ES	97.32		
Length = 3.00 m - 9' 10"				
32 - 1-9/32	K32 ES/300	116.79		



Schluter®-ECK-KHK

Schluter®-ECK-KHK is a stainless steel profile for inside wall corners that produces a radiused edge for a clean, decorative finish. ECK-KHK provides a 5/16" (8 mm) radius to prevent the accumulation of dirt and make cleaning simple. Thus, the profile is especially suited for commercial kitchens, bathrooms, food processing plants or any environment where a sanitary corner is desired. ECK-KHK is subsequently bonded to the inside corners of existing tile or other wall coverings. As such, the profile can be installed as a repair so that existing, damaged corners do not have to be replaced.

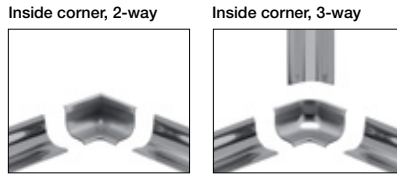
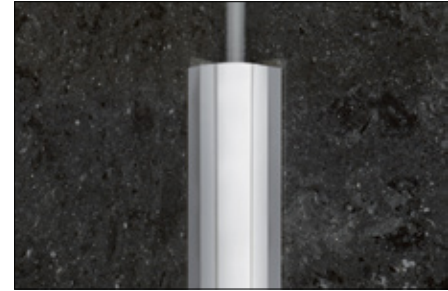
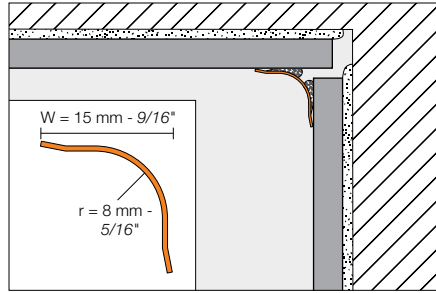

Schluter®-ECK-KHK						
Stainless steel 304 (1.4301 = V2A) (E)						
W = mm - in.	Profile	\$ / Length	Outside corner, 90°	Inside corner, 90° (2-way)	Inside corner, 90° (3-way)	\$ / Unit
Length = 1.50 m - 4' 11"			E/KHK 15 E	1/2KHK 15 E	1/3KHK 15 E	10.71
15 - 9/16	KHK 15 E/150	25.16				
Length = 2.00 m - 6' 7"						
15 - 9/16	KHK 15 E/200	33.54				
Length = 2.5 m - 8' 2-1/2"						
15 - 9/16	KHK 15 E	41.93				
Length = 3.00 m - 9' 10"						
15 - 9/16	KHK 15 E/300	50.31	V/KHK 15 E			7.27
Connector						

Brushed stainless steel 304 (1.4301 = V2A) (EB)						
W = mm - in.	Profile	\$ / Length	Outside corner, 90°	Inside corner, 90° (2-way)	Inside corner, 90° (3-way)	\$ / Unit
Length = 1.50 m - 4' 11"			E/KHK 15 EB	1/2KHK 15 EB	1/3KHK 15 EB	10.71
15 - 9/16	KHK 15 EB/150	28.25				
Length = 2.00 m - 6' 7"						
15 - 9/16	KHK 15 EB/200	37.66				
Length = 2.5 m - 8' 2-1/2"						
15 - 9/16	KHK 15 EB	47.09				
Length = 3.00 m - 9' 10"						
15 - 9/16	KHK 15 EB/300	56.51	V/KHK 15 EB			7.27
Connector						



Schluter®-ECK-KI

Schluter®-ECK-KI is a stainless steel profile for inside wall corners that produces a clean, decorative finish. ECK-KI is subsequently bonded to the inside corners of existing tile or other wall coverings. As such, the profile can be installed as a repair so that existing, damaged corners do not have to be replaced.

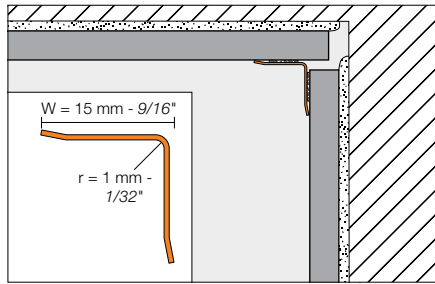

Schluter®-ECK-KI				
W = mm - in.	Stainless steel 304 (1.4301 = V2A) (E)		Brushed stainless steel 304 (1.4301 = V2A) (EB)	
	Item No.	\$ / Length	Item No.	\$ / Length
Length = 1.50 m - 4' 11"				
15 - 9/16	KI15 E/150	25.16	KI15 EB/150	28.25
Length = 2.00 m - 6' 7"				
15 - 9/16	KI15 E/200	33.54	KI15 EB/200	37.66
Length = 2.5 m - 8' 2-1/2"				
15 - 9/16	KI15 E	41.93	KI15 EB	47.09
Length = 3.00 m - 9' 10"				
15 - 9/16	KI15 E/300	50.31	KI15 EB/300	56.51

Schluter®-REMA

Schluter®-REMA is a system for creating concealed access panels in tiled walls without impairing the visual appearance of the tile covering. REMA is suited for all tile sizes and thicknesses, and adapts perfectly to the joint pattern.

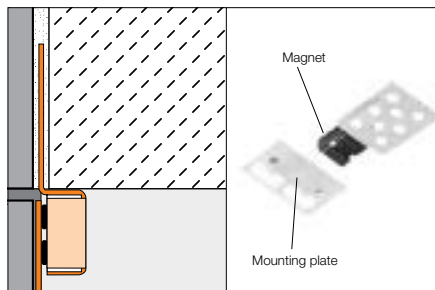

Schluter®-REMA	
Set = 4 Magnets + 4 Mounting plates	
Item No.	\$ / Set
REMA	11.38



Schluter®-DESIGNBASE-SL

The Schluter®-DESIGNBASE-SL profile provides a modern alternative to traditional baseboards. The profile is available in brushed stainless steel, anodized aluminum, and color-coated aluminum. DESIGNBASE features a clean, sleek look, and is simply attached to the wall with a suitable adhesive. An optional sealing lip accessory is available to protect the floor/wall transition from moisture penetration and to reduce the transmission of impact sound.

The brushed stainless steel profile is available in 4-3/8" or 6-3/8" (110 or 160 mm) heights to meet code requirements for a commercial cove base.

The anodized and color-coated aluminum profiles are available in 2-3/8" or 3-1/8" (60 or 80 mm) heights.

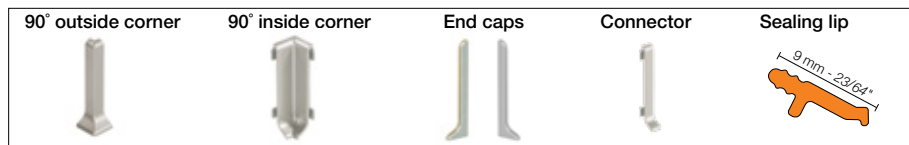
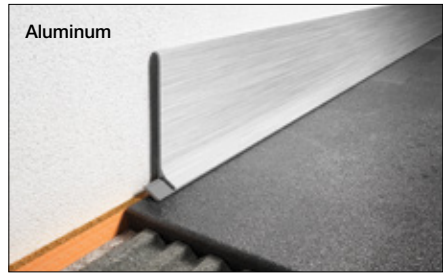
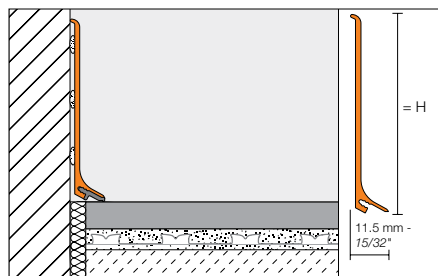
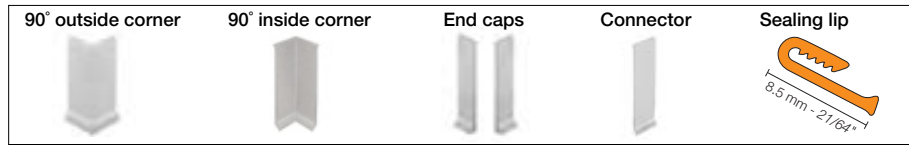
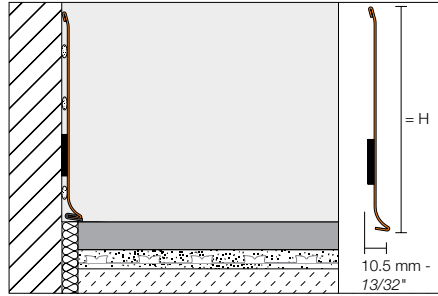

Schluter®-DESIGNBASE-SL-E

Length = 2.5 m - 8' 2-1/2"		Brushed stainless steel 304 (1.4301 = V2A) (EB)				
H = mm - in.	Profile	\$ / Length	Outside corner, 90°	\$ / Unit	Inside corner, 90°	\$ / Unit
110 - 4-3/8	DB SL 110 EB	120.26	E90 / DB SL 110 EB	59.90	I90 / DB SL 110 EB	59.90
160 - 6-3/8	DB SL 160 EB	168.61	E90 / DB SL 160 EB	61.95	I90 / DB SL 160 EB	61.95

H = mm - in.	End cap (left)	\$ / Unit	End cap (right)	\$ / Unit	Connector	\$ / Unit
110 - 4-3/8	EL / DB SL 110 EB	59.90	ER / DB SL 110 EB	59.90	V / DB SL 110 EB	32.57
160 - 6-3/8	EL / DB SL 160 EB	61.95	ER / DB SL 160 EB	61.95	V / DB SL 160 EB	33.65

Length = 2.5 m - 8' 2-1/2"		Schluter®-DESIGNBASE-SLZ-E	
Sealing lip		\$ / Length	
DB ZS LL E		18.44	

Schluter®-DESIGNBASE-SL

Length = 2.5 m - 8' 2-1/2"		Satin anodized aluminum (AE)				
H = mm - in.	Profile	\$ / Length	Outside corner, 90°	\$ / Unit	Inside corner, 90°	\$ / Unit
60 - 2-3/8	DB SL 60 AE	28.63	ED / DB SL 60 AE	10.47	ID / DB SL 60 AE	10.47
80 - 3-1/8	DB SL 80 AE	34.99	ED / DB SL 80 AE	10.47	ID / DB SL 80 AE	10.47

H = mm - in.	End cap (left)	\$ / Unit	End cap (right)	\$ / Unit	Connector	\$ / Unit
60 - 2-3/8	EL / DB SL 60 AE	9.20	ER / DB SL 60 AE	9.20	V / DB SL 60 AE	9.20
80 - 3-1/8	EL / DB SL 80 AE	9.20	ER / DB SL 80 AE	9.20	V / DB SL 80 AE	9.20

Schluter®-DESIGNBASE-SL

Length = 2.5 m - 8' 2-1/2"	Anodized aluminum with brushed stainless steel appearance (AEEB)					
H = mm - in.	Profile	\$ / Length	Outside corner, 90°	\$ / Unit	Inside corner, 90°	\$ / Unit
60 - 2-3/8	DB SL 60 AEEB	88.53	ED / DB SL 60 AEEB	10.47	ID / DB SL 60 AEEB	10.47
80 - 3-1/8	DB SL 80 AEEB	116.12	ED / DB SL 80 AEEB	10.47	ID / DB SL 80 AEEB	10.47

H = mm - in.	End cap (left)	\$ / Unit	End cap (right)	\$ / Unit	Connector	\$ / Unit
60 - 2-3/8	EL / DB SL 60 AEEB	9.20	ER / DB SL 60 AEEB	9.20	V / DB SL 60 AEEB	9.20
80 - 3-1/8	EL / DB SL 80 AEEB	9.20	ER / DB SL 80 AEEB	9.20	V / DB SL 80 AEEB	9.20

Note: For reasons associated with production technology, inside corners ID / DB SL 60 AEEB and ID / DB SL 80 AEEB are not brushed.

Length = 2.5 m - 8' 2-1/2"	Matte white color-coated aluminum (MBW)					
H = mm - in.	Profile	\$ / Length	Outside corner, 90°	\$ / Unit	Inside corner, 90°	\$ / Unit
60 - 2-3/8	DB SL 60 MBW	49.18	ED / DB SL 60 MBW	10.47	ID / DB SL 60 MBW	10.47
80 - 3-1/8	DB SL 80 MBW	69.79	ED / DB SL 80 MBW	10.47	ID / DB SL 80 MBW	10.47

H = mm - in.	End cap (left)	\$ / Unit	End cap (right)	\$ / Unit	Connector	\$ / Unit
60 - 2-3/8	EL / DB SL 60 MBW	9.20	ER / DB SL 60 MBW	9.20	V / DB SL 60 MBW	9.20
80 - 3-1/8	EL / DB SL 80 MBW	9.20	ER / DB SL 80 MBW	9.20	V / DB SL 80 MBW	9.20

Length = 2.5 m - 8' 2-1/2"	Schluter®-DESIGNBASE-SLZ	
	Sealing lip	\$ / Length
	DB ZS LL	10.47



Schluter® Profiles

Edge-protection & slip-resistant profiles for stairs

Tiled stair edges are vulnerable to chipping and breaking and create a slip hazard, especially in exterior applications. Schluter stair-nosing profiles protect exposed tile edges and improve safety on tiled stairways by providing slip-resistant wear surfaces and increased visibility—all while providing decorative accents within the tile covering.

Stair-nosing profiles are available in a variety of shapes, sizes, materials, and finishes, with options designed for both commercial and residential applications.





Schluter®-RONDEC-STEP

Schluter®-RONDEC-STEP is a finishing and edging profile for ceramic tile and dimension stone installations on countertops and stairs. The top of the profile features a symmetrically rounded edge that matches the Schluter®-RONDEC profile (page 28), while the vertical leg of the profile hides the exposed edge of the sub-assembly. RONDEC-STEP features an integrated joint spacer that establishes a defined joint cavity between the tile and the profile.

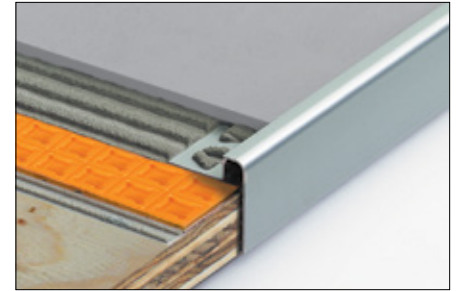
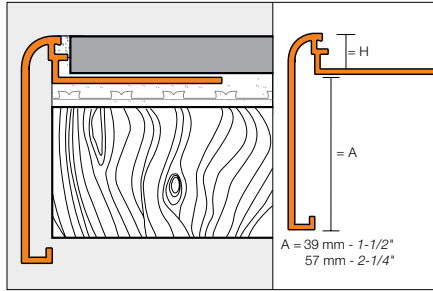

Outside corner (90° or 135°)

Inside corner (90° or 135°)



Schluter®-RONDEC-STEP

Length = 2.5 m - 8' 2-1/2"		Satin anodized aluminum (AE)						
H = mm - in.	Profile	\$/ Length	Outside corner, 90°	Outside corner, 135°	Inside corner, 90°	Inside corner, 135°	\$/ Unit	
A: 39 mm - 1-1/2"								
8 - 5/16	RS 80 AE 39	47.18	E90 RS 80 AE 39	E135 RS 80 AE 39	I90 RS 80 AE 39	I135 RS 80 AE 39	22.01	
10 - 3/8	RS 100 AE 39	47.95	E90 RS 100 AE 39	E135 RS 100 AE 39	I90 RS 100 AE 39	I135 RS 100 AE 39	22.01	
12.5 - 1/2	RS 125 AE 39	49.58	E90 RS 125 AE 39	E135 RS 125 AE 39	I90 RS 125 AE 39	I135 RS 125 AE 39	22.01	
A: 57 mm - 2-1/4"								
8 - 5/16	RS 80 AE 57	48.40	E90 RS 80 AE 57	E135 RS 80 AE 57	I90 RS 80 AE 57	I135 RS 80 AE 57	22.01	
10 - 3/8	RS 100 AE 57	49.18	E90 RS 100 AE 57	E135 RS 100 AE 57	I90 RS 100 AE 57	I135 RS 100 AE 57	22.01	
12.5 - 1/2	RS 125 AE 57	51.46	E90 RS 125 AE 57	E135 RS 125 AE 57	I90 RS 125 AE 57	I135 RS 125 AE 57	22.01	

Length = 2.5 m - 8' 2-1/2"		Brushed chrome anod. alu. (ACGB)						
H = mm - in.	Profile	\$/ Length	Outside corner, 90°	Outside corner, 135°	Inside corner, 90°	Inside corner, 135°	\$/ Unit	
A: 39 mm - 1-1/2"								
8 - 5/16	RS 80 ACGB 39	61.77	E90 RS 80 ACGB 39	E135 RS 80 ACGB 39	I90 RS 80 ACGB 39	I135 RS 80 ACGB 39	24.85	
10 - 3/8	RS 100 ACGB 39	62.46	E90 RS 100 ACGB 39	E135 RS 100 ACGB 39	I90 RS 100 ACGB 39	I135 RS 100 ACGB 39	24.85	
12.5 - 1/2	RS 125 ACGB 39	64.61	E90 RS 125 ACGB 39	E135 RS 125 ACGB 39	I90 RS 125 ACGB 39	I135 RS 125 ACGB 39	24.85	
A: 57 mm - 2-1/4"								
8 - 5/16	RS 80 ACGB 57	62.91	E90 RS 80 ACGB 57	E135 RS 80 ACGB 57	I90 RS 80 ACGB 57	I135 RS 80 ACGB 57	24.85	
10 - 3/8	RS 100 ACGB 57	63.62	E90 RS 100 ACGB 57	E135 RS 100 ACGB 57	I90 RS 100 ACGB 57	I135 RS 100 ACGB 57	24.85	
12.5 - 1/2	RS 125 ACGB 57	65.74	E90 RS 125 ACGB 57	E135 RS 125 ACGB 57	I90 RS 125 ACGB 57	I135 RS 125 ACGB 57	24.85	

Length = 2.5 m - 8' 2-1/2"		Satin nickel anod. alu. (AT)						
H = mm - in.	Profile	\$/ Length	Outside corner, 90°	Outside corner, 135°	Inside corner, 90°	Inside corner, 135°	\$/ Unit	
A: 39 mm - 1-1/2"								
8 - 5/16	RS 80 AT 39	47.18	E90 RS 80 AT 39	E135 RS 80 AT 39	I90 RS 80 AT 39	I135 RS 80 AT 39	22.01	
10 - 3/8	RS 100 AT 39	47.95	E90 RS 100 AT 39	E135 RS 100 AT 39	I90 RS 100 AT 39	I135 RS 100 AT 39	22.01	
12.5 - 1/2	RS 125 AT 39	49.58	E90 RS 125 AT 39	E135 RS 125 AT 39	I90 RS 125 AT 39	I135 RS 125 AT 39	22.01	
A: 57 mm - 2-1/4"								
8 - 5/16	RS 80 AT 57	48.40	E90 RS 80 AT 57	E135 RS 80 AT 57	I90 RS 80 AT 57	I135 RS 80 AT 57	22.01	
10 - 3/8	RS 100 AT 57	49.18	E90 RS 100 AT 57	E135 RS 100 AT 57	I90 RS 100 AT 57	I135 RS 100 AT 57	22.01	
12.5 - 1/2	RS 125 AT 57	51.46	E90 RS 125 AT 57	E135 RS 125 AT 57	I90 RS 125 AT 57	I135 RS 125 AT 57	22.01	

Length = 2.5 m - 8' 2-1/2"		Brushed nickel anod. alu. (ATGB)						
H = mm - in.	Profile	\$/ Length	Outside corner, 90°	Outside corner, 135°	Inside corner, 90°	Inside corner, 135°	\$/ Unit	
A: 39 mm - 1-1/2"								
8 - 5/16	RS 80 ATGB 39	61.77	E90 RS 80 ATGB 39	E135 RS 80 ATGB 39	I90 RS 80 ATGB 39	I135 RS 80 ATGB 39	24.85	
10 - 3/8	RS 100 ATGB 39	62.46	E90 RS 100 ATGB 39	E135 RS 100 ATGB 39	I90 RS 100 ATGB 39	I135 RS 100 ATGB 39	24.85	
12.5 - 1/2	RS 125 ATGB 39	64.61	E90 RS 125 ATGB 39	E135 RS 125 ATGB 39	I90 RS 125 ATGB 39	I135 RS 125 ATGB 39	24.85	



Schluter®-RONDEC-STEP

Length = 2.5 m - 8' 2-1/2"							
Satin copper anod. alu. (AK)							
H = mm - in.	Profile	\$ / Length	Outside corner, 90°	Outside corner, 135°	Inside corner, 90°	Inside corner, 135°	\$ / Unit
A: 39 mm - 1-1/2"							
8 - 5/16	RS 80 AK 39	47.18	E90 RS 80 AK 39	E135 RS 80 AK 39	I90 RS 80 AK 39	I135 RS 80 AK 39	22.01
10 - 3/8	RS 100 AK 39	47.95	E90 RS 100 AK 39	E135 RS 100 AK 39	I90 RS 100 AK 39	I135 RS 100 AK 39	22.01
12.5 - 1/2	RS 125 AK 39	49.58	E90 RS 125 AK 39	E135 RS 125 AK 39	I90 RS 125 AK 39	I135 RS 125 AK 39	22.01
A: 57 mm - 2-1/4"							
8 - 5/16	RS 80 AK 57	48.40	E90 RS 80 AK 57	E135 RS 80 AK 57	I90 RS 80 AK 57	I135 RS 80 AK 57	22.01
10 - 3/8	RS 100 AK 57	49.18	E90 RS 100 AK 57	E135 RS 100 AK 57	I90 RS 100 AK 57	I135 RS 100 AK 57	22.01
12.5 - 1/2	RS 125 AK 57	51.46	E90 RS 125 AK 57	E135 RS 125 AK 57	I90 RS 125 AK 57	I135 RS 125 AK 57	22.01

Length = 2.5 m - 8' 2-1/2"							
Brushed copper anod. alu. (AKGB)							
H = mm - in.	Profile	\$ / Length	Outside corner, 90°	Outside corner, 135°	Inside corner, 90°	Inside corner, 135°	\$ / Unit
A: 39 mm - 1-1/2"							
8 - 5/16	RS 80 AKGB 39	61.77	E90 RS 80 AKGB 39	E135 RS 80 AKGB 39	I90 RS 80 AKGB 39	I135 RS 80 AKGB 39	24.85
10 - 3/8	RS 100 AKGB 39	62.46	E90 RS 100 AKGB 39	E135 RS 100 AKGB 39	I90 RS 100 AKGB 39	I135 RS 100 AKGB 39	24.85
12.5 - 1/2	RS 125 AKGB 39	64.61	E90 RS 125 AKGB 39	E135 RS 125 AKGB 39	I90 RS 125 AKGB 39	I135 RS 125 AKGB 39	24.85
A: 57 mm - 2-1/4"							
8 - 5/16	RS 80 AKGB 57	62.91	E90 RS 80 AKGB 57	E135 RS 80 AKGB 57	I90 RS 80 AKGB 57	I135 RS 80 AKGB 57	24.85
10 - 3/8	RS 100 AKGB 57	63.62	E90 RS 100 AKGB 57	E135 RS 100 AKGB 57	I90 RS 100 AKGB 57	I135 RS 100 AKGB 57	24.85
12.5 - 1/2	RS 125 AKGB 57	65.74	E90 RS 125 AKGB 57	E135 RS 125 AKGB 57	I90 RS 125 AKGB 57	I135 RS 125 AKGB 57	24.85

Length = 2.5 m - 8' 2-1/2"							
Satin brass anod. alu. (AM)							
H = mm - in.	Profile	\$ / Length	Outside corner, 90°	Outside corner, 135°	Inside corner, 90°	Inside corner, 135°	\$ / Unit
A: 57 mm - 2-1/4"							
8 - 5/16	RS 80 AM 57	48.40	E90 RS 80 AM 57	E135 RS 80 AM 57	I90 RS 80 AM 57	I135 RS 80 AM 57	22.01
10 - 3/8	RS 100 AM 57	49.18	E90 RS 100 AM 57	E135 RS 100 AM 57	I90 RS 100 AM 57	I135 RS 100 AM 57	22.01
12.5 - 1/2	RS 125 AM 57	51.46	E90 RS 125 AM 57	E135 RS 125 AM 57	I90 RS 125 AM 57	I135 RS 125 AM 57	22.01

Length = 2.5 m - 8' 2-1/2"							
Brushed brass anod. alu. (AMGB)							
H = mm - in.	Profile	\$ / Length	Outside corner, 90°	Outside corner, 135°	Inside corner, 90°	Inside corner, 135°	\$ / Unit
A: 39 mm - 1-1/2"							
8 - 5/16	RS 80 AMGB 39	61.77	E90 RS 80 AMGB 39	E135 RS 80 AMGB 39	I90 RS 80 AMGB 39	I135 RS 80 AMGB 39	24.85
10 - 3/8	RS 100 AMGB 39	62.46	E90 RS 100 AMGB 39	E135 RS 100 AMGB 39	I90 RS 100 AMGB 39	I135 RS 100 AMGB 39	24.85
12.5 - 1/2	RS 125 AMGB 39	64.61	E90 RS 125 AMGB 39	E135 RS 125 AMGB 39	I90 RS 125 AMGB 39	I135 RS 125 AMGB 39	24.85
A: 57 mm - 2-1/4"							
8 - 5/16	RS 80 AMGB 57	62.91	E90 RS 80 AMGB 57	E135 RS 80 AMGB 57	I90 RS 80 AMGB 57	I135 RS 80 AMGB 57	24.85
10 - 3/8	RS 100 AMGB 57	63.62	E90 RS 100 AMGB 57	E135 RS 100 AMGB 57	I90 RS 100 AMGB 57	I135 RS 100 AMGB 57	24.85
12.5 - 1/2	RS 125 AMGB 57	65.74	E90 RS 125 AMGB 57	E135 RS 125 AMGB 57	I90 RS 125 AMGB 57	I135 RS 125 AMGB 57	24.85

Length = 2.5 m - 8' 2-1/2"							
Brushed antique bronze anod. alu. (ABGB)							
H = mm - in.	Profile	\$ / Length	Outside corner, 90°	Outside corner, 135°	Inside corner, 90°	Inside corner, 135°	\$ / Unit
A: 39 mm - 1-1/2"							
8 - 5/16	RS 80 ABGB 39	61.77	E90 RS 80 ABGB 39	E135 RS 80 ABGB 39	I90 RS 80 ABGB 39	I135 RS 80 ABGB 39	24.85
10 - 3/8	RS 100 ABGB 39	62.46	E90 RS 100 ABGB 39	E135 RS 100 ABGB 39	I90 RS 100 ABGB 39	I135 RS 100 ABGB 39	24.85
12.5 - 1/2	RS 125 ABGB 39	64.61	E90 RS 125 ABGB 39	E135 RS 125 ABGB 39	I90 RS 125 ABGB 39	I135 RS 125 ABGB 39	24.85



Schluter®-SCHIENE-STEP

Schluter®-SCHIENE-STEP is a finishing and edging profile for ceramic tile and natural stone installations on countertops, stairs, and tile over tile applications on walls. The top of the profile features a vertical wall section that finishes and protects the tile from damage, while the vertical leg covers the edge of the sub-assembly, top of the riser, or existing wall tile edge.

SCHIENE-STEP is available in anodized aluminum and brushed stainless steel versions, which have different shapes and intended uses. The stainless steel version is available in three vertical leg lengths: 1-1/2" (39 mm), 1-3/16" (30 mm), and 7/16" (11 mm). The anodized aluminum version is intended for residential stair applications (stairs not exposed to heavy traffic). It is available in two vertical leg lengths, 1-3/16" (30 mm) and 1-1/2" (39 mm). The ribbed vertical leg covers the sub-assembly or top of the riser. The integrated joint spacer establishes a defined joint cavity between the tile and the profile.

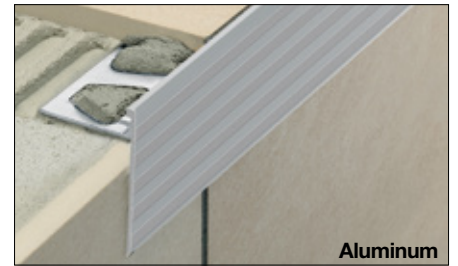
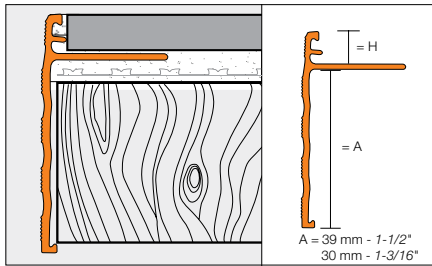
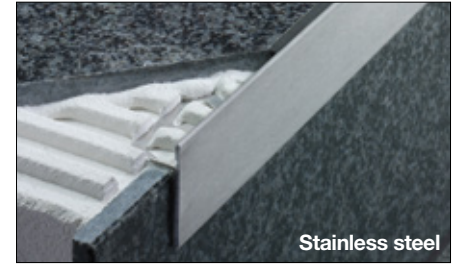
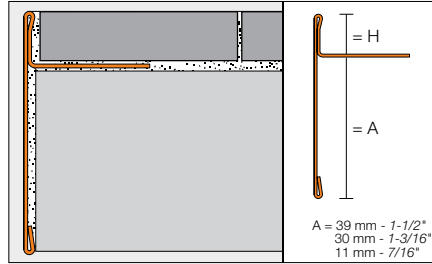

Schluter®-SCHIENE-STEP									
Length = 2.5 m - 8' 2-1/2"	Brushed Stainless Steel 304 (1.4301 = V2A) (EB)								
H = mm - in.	Profile	\$ / Length	Inside corner, 90°	Inside corner, 135°	Outside corner, 90° and End Cap	Outside corner, 135°	\$ / Unit		
A: 39 mm - 1-1/2"									
6 - 1/4	SS 60 EB 39	143.10	I90 / SS 60 EB 39	I135 / SS 60 EB 39	E90 / SS 60 EB 39	E135 / SS 60 EB 39	18.90		
9 - 11/32	SS 90 EB 39	149.04	I90 / SS 90 EB 39	I135 / SS 90 EB 39	E90 / SS 90 EB 39	E135 / SS 90 EB 39	18.90		
11 - 7/16	SS 110 EB 39	151.73	I90 / SS 110 EB 39	I135 / SS 110 EB 39	E90 / SS 110 EB 39	E135 / SS 110 EB 39	18.90		
12.5 - 1/2	SS 125 EB 39	154.12	I90 / SS 125 EB 39	I135 / SS 125 EB 39	E90 / SS 125 EB 39	E135 / SS 125 EB 39	18.90		
A: 30 mm - 1-3/16"									
9 - 11/32	SS 90 EB 30	112.69	-	-	E90 / SS 90 EB 30	-	18.90		
11 - 7/16	SS 110 EB 30	114.13	-	-	E90 / SS 110 EB 30	-	18.90		
12.5 - 1/2	SS 125 EB 30	115.58	-	-	E90 / SS 125 EB 30	-	18.90		
A: 11 mm - 7/16"									
6 - 1/4	SS 60 EB 11	108.41							
12.5 - 1/2	SS 125 EB 11	109.81							

Brushed Stainless Steel 304 (1.4301 = V2A) (EB)		
H = mm - in.	Connector	\$ / Unit
A: 39 mm - 1-1/2"		
6 - 1/4	V / SS 60 EB 39	16.07
9 - 11/32	V / SS 90 EB 39	16.07
11 - 7/16	V / SS 110 EB 39	16.07
12.5 - 1/2	V / SS 125 EB 39	16.07
A: 30 mm - 1-3/16"		
9 - 11/32	V / SS 90 EB 30	16.07
11 - 7/16	V / SS 110 EB 30	16.07
12.5 - 1/2	V / SS 125 EB 30	16.07
A: 11 mm - 7/16"		
6 - 1/4	V / SS 60 EB 11	16.07
12.5 - 1/2	V / SS 125 EB 11	16.07

Schluter®-SCHIENE-STEP				
Length = 2.5 m - 8' 2-1/2"	Satin anodized aluminum (AE)		Satin nickel anodized aluminum (AT)	
H = mm - in.	Profile	\$ / Length	Profile	\$ / Length
A: 30 mm - 1-3/16"				
8 - 5/16	SS 80 AE 30	39.28	SS 80 AT 30	43.34
10 - 3/8	SS 100 AE 30	39.90	SS 100 AT 30	43.79
12.5 - 1/2	SS 125 AE 30	40.63	SS 125 AT 30	44.52
15 - 9/16	SS 150 AE 30	41.25	SS 150 AT 30	45.13
A: 39 mm - 1-1/2"				
8 - 5/16	SS 80 AE 39	42.72	SS 80 AT 39	46.60
10 - 3/8	SS 100 AE 39	43.41	SS 100 AT 39	47.28
12.5 - 1/2	SS 125 AE 39	44.01	SS 125 AT 39	47.91
15 - 9/16	SS 150 AE 39	44.70	SS 150 AT 39	48.57

Note: The anchoring leg of **Schluter®-SCHIENE-STEP** is available with a special radius perforation so that the profile can be used to form curves.

- Available in stainless steel only
- Price surcharge: \$0.70 per foot
- Item No.: R / Profile No. (e.g., R/SS 60 EB 11)
- For delivery time, please call Customer Service





Schluter®-TREP-FL

Schluter®-TREP-FL is a decorative stair-nosing profile with a protruding rounded edge that can be integrated into stairs covered with tile or stone. The profile protects the front edge of stairs and adds a high degree of safety by improving the visibility of the stair edges. The profile is available in stainless steel or anodized aluminum. TREP-FL is suitable for residential applications, e.g., stairs not exposed to heavy traffic.

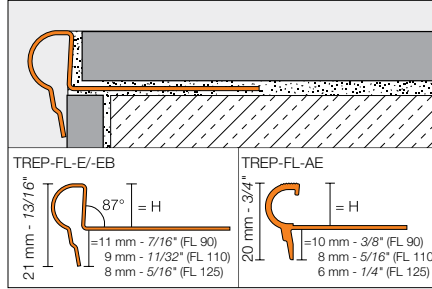

End cap (E)



Schluter®-TREP-FL		
Stainless steel 304 (1.4301 = V2A) (E)		
H = mm - in.	Item No.	\$ / Length
Length = 2.5 m - 8' 2-1/2"		
9 - 11/32	FL 90 E	66.59
11 - 7/16	FL 110 E	69.51
12.5 - 1/2	FL 125 E	72.60
Length = 1.50 m - 4' 11"		
9 - 11/32	FL 90 E/150	39.94
11 - 7/16	FL 110 E/150	41.70
12.5 - 1/2	FL 125 E/150	43.56
End cap		\$ / Unit
E/FLEB		4.75

Schluter®-TREP-FL		
Brushed stainless steel 304 (1.4301 = V2A) (EB)		
H = mm - in.	Item No.	\$ / Length
Length = 2.5 m - 8' 2-1/2"		
9 - 11/32	FL 90 EB	79.92
11 - 7/16	FL 110 EB	83.42
12.5 - 1/2	FL 125 EB	87.11
Length = 1.50 m - 4' 11"		
9 - 11/32	FL 90 EB/150	47.96
11 - 7/16	FL 110 EB/150	50.03
12.5 - 1/2	FL 125 EB/150	52.28
End cap		\$ / Unit
E/FLEB		4.75

Schluter®-TREP-FL		
Satin anodized aluminum (AE)		
H = mm - in.	Item No.	\$ / Length
Length = 2.5 m - 8' 2-1/2"		
9 - 11/32	FL 90 AE	30.46
11 - 7/16	FL 110 AE	31.10
12.5 - 1/2	FL 125 AE	31.72
Length = 1.50 m - 4' 11"		
9 - 11/32	FL 90 AE/150	21.58
11 - 7/16	FL 110 AE/150	21.97
12.5 - 1/2	FL 125 AE/150	23.61
End cap		\$ / Unit
E/FLAE		1.92



Schluter®-TREP-E

Schluter®-TREP-E is designed to protect tiled stair edges and provide an easily visible, slip-resistant wear surface for durable, safe, and visually appealing stair-nosing design. The profile is made of stainless steel with an integrated slip-resistant tread, making it suitable for interior and exterior use in areas subjected to heavy foot-traffic, such as offices or public buildings. TREP-E features a trapezoid-perforated anchoring leg that is secured in the bond coat beneath the tile.

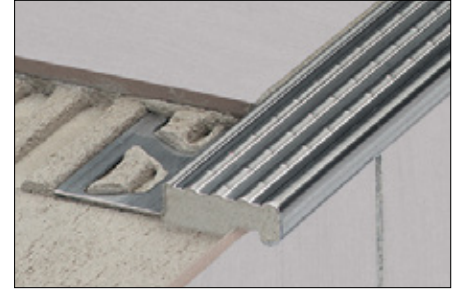
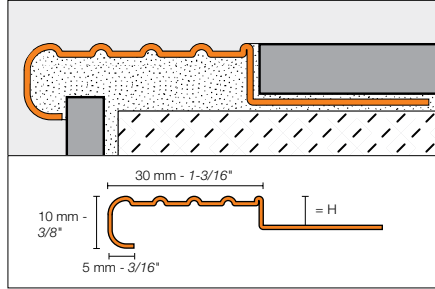

Note: Sizes 80, 110, and 160 are also available in stainless steel 316L (1.4404 = V4A). Contact Customer Service for pricing and availability.



A version without the anchoring leg for retrofit applications is also available. Please refer to TREP-EK on page 70.

Schluter®-TREP-E		
Stainless steel 304 (1.4301 = V2A) (E)		
H = mm - in.	Item No.	\$ / Length
Length = 2.5 m - 8' 2-1/2"		
2 - 3/32	TE 20	49.09
5 - 3/16	TE 50	50.75
8 - 5/16	TE 80	52.26
11 - 7/16	TE 110	53.80
16 - 5/8	TE 160	56.39
25 - 1	TE 250	60.58
Length = 1.50 m - 4' 11"		
2 - 3/32	TE 20/150	30.71
5 - 3/16	TE 50/150	31.72
8 - 5/16	TE 80/150	32.68
11 - 7/16	TE 110/150	33.60
16 - 5/8	TE 160/150	35.27
25 - 1	TE 250/150	38.28
End cap		\$ / Unit
E/TE		3.12

End cap (E/)

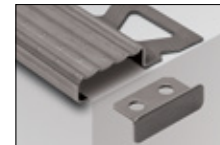

Schluter®-TREP-E



Schluter®-TREP-G

Schluter®-TREP-G is designed to protect tiled stair edges and provide an easily visible, slip-resistant wear surface for durable, safe, and visually appealing stair-nosing design. The profile is made of stainless steel, making it suitable for interior and exterior use in areas subjected to heavy foot-traffic, such as offices or public buildings. The surface features a self-adhesive, non-slip tread with an embedded mineral grain coating, which can be replaced in case of damage or wear. TREP-G features a trapezoid-perforated anchoring leg that is secured in the bond coat beneath the tile.

Note: Sizes 130 and 150 are not stocked. Please call Customer Service for delivery times.



A version without the anchoring leg for retrofit applications is also available. Please refer to TREP-GK on page 71.

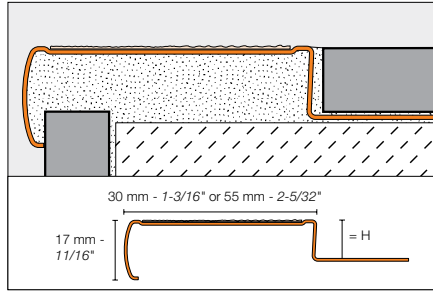

Schluter®-TREP-G-S		
Brushed stainless steel support with non-slip tread (30 mm - 1-3/16")		
H = mm - in.	Item No.	\$ / Length
Length = 2.5 m - 8' 2-1/2"		
9 - 11/32	GS EB 90 + color*	138.16
11 - 7/16	GS EB 110 + color*	139.66
13 - 33/64	GS EB 130 + color*	141.12
15 - 9/16	GS EB 150 + color*	143.54
Length = 1.50 m - 4' 11"		
9 - 11/32	GS EB 90 + color*/150	87.51
11 - 7/16	GS EB 110 + color*/150	88.47
13 - 33/64	GS EB 130 + color*/150	89.38
15 - 9/16	GS EB 150 + color*/150	90.74
Replacement tread		
Length = 18.3 m - 60' 1/32"		\$ / Unit
GS KB 183 + color*		152.27
End cap		\$ / Unit
E/GS EB		4.70

Schluter®-TREP-G-B		
Brushed stainless steel support with non-slip tread (55 mm - 2-5/32")		
H = mm - in.	Item No.	\$ / Length
Length = 2.5 m - 8' 2-1/2"		
9 - 11/32	GB EB 90 + color*	177.27
11 - 7/16	GB EB 110 + color*	178.51
13 - 33/64	GB EB 130 + color*	180.00
15 - 9/16	GB EB 150 + color*	181.48
Length = 1.50 m - 4' 11"		
9 - 11/32	GB EB 90 + color*/150	111.65
11 - 7/16	GB EB 110 + color*/150	112.45
13 - 33/64	GB EB 130 + color*/150	113.38
15 - 9/16	GB EB 150 + color*/150	114.30
Replacement tread		
Length = 18.3 m - 60' 1/32"		\$ / Unit
GB KB 183 + color*		274.41
End cap		\$ / Unit
E/GB EB		4.70

***Color Codes**

Transparent

Black

* To complete the item number, add the color code (e.g., GS EB 90 GS).

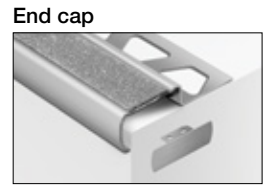



Schluter®-TREP-V



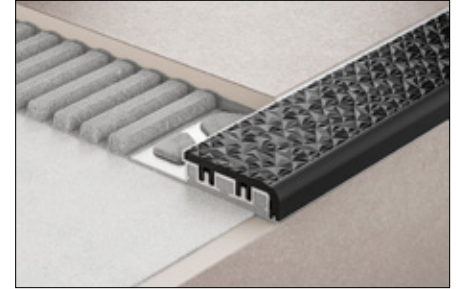
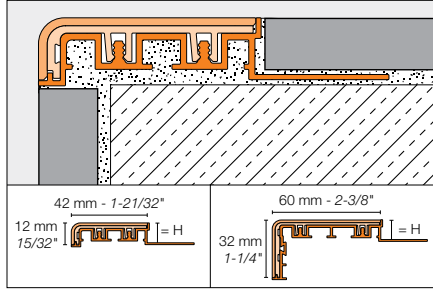



Schluter®-TREP-V is an anodized aluminum profile with a PVC tread designed to protect tiled stair edges. The specially textured slip resistant tread makes TREP-V well suited for use in areas with heavy foot traffic, such as offices or public buildings. The replaceable PVC tread is available in a variety of colors including high visibility options. TREP-V is available with either a narrow (TREP-V 42) or wide (TREP-V 60) tread. End caps are also available.



Schluter®-TREP-V 42			
Anodized aluminum support with slip-resistant PVC insert (42 mm / 12 mm - 1-21/32" / 15/32")			
H = mm - in.	Item No.		\$/ Length
Length = 1 m - 3' 3"			
9 - 11/32	TVL 42 + color* 90/100		26.03
11 - 7/16	TVL 42 + color* 110/100		27.63
12.5 - 1/2	TVL 42 + color* 125/100		28.83
Length = 1.50 m - 4' 11"			
9 - 11/32	TVL 42 + color* 90/150		39.41
11 - 7/16	TVL 42 + color* 110/150		41.82
12.5 - 1/2	TVL 42 + color* 125/150		43.64
Length = 2 m - 6' 7"			
9 - 11/32	TVL 42 + color* 90/200		52.71
11 - 7/16	TVL 42 + color* 110/200		55.93
12.5 - 1/2	TVL 42 + color* 125/200		58.36
Length = 3.05 m - 10'			
9 - 11/32	TVL 42 + color* 90/300		78.90
11 - 7/16	TVL 42 + color* 110/300		83.70
12.5 - 1/2	TVL 42 + color* 125/300		87.30
Replacement PVC insert (42 mm / 12 mm - 1-21/32" / 15/32")			
Length = 2 m - 6' 7"			
	TVL 42 + color*/200		21.02
Length = 3.05 m - 10'			
	TVL 42 + color*/300		31.32
End cap (1 right + 1 left)			\$/ Set
	E / TV 42 + color*		4.00

Schluter®-TREP-V 60			
Anodized aluminum support with slip-resistant PVC insert (60 mm / 32 mm - 2-3/8" / 1-1/4")			
H = mm - in.	Item No.		\$/ Length
Length = 1 m - 3' 3"			
9 - 11/32	TVL 60 + color* 90/100		36.11
11 - 7/16	TVL 60 + color* 110/100		38.29
12.5 - 1/2	TVL 60 + color* 125/100		39.94
Length = 1.50 m - 4' 11"			
9 - 11/32	TVL 60 + color* 90/150		54.66
11 - 7/16	TVL 60 + color* 110/150		57.96
12.5 - 1/2	TVL 60 + color* 125/150		60.47
Length = 2 m - 6' 7"			
9 - 11/32	TVL 60 + color* 90/200		73.10
11 - 7/16	TVL 60 + color* 110/200		77.51
12.5 - 1/2	TVL 60 + color* 125/200		80.87
Length = 3.05 m - 10'			
9 - 11/32	TVL 60 + color* 90/300		109.30
11 - 7/16	TVL 60 + color* 110/300		115.90
12.5 - 1/2	TVL 60 + color* 125/300		121.00
Replacement PVC insert (60 mm / 32 mm - 2-3/8" / 1-1/4")			
Length = 2 m - 6' 7"			
	TVL 60 + color*/200		29.13
Length = 3.05 m - 10'			
	TVL 60 + color*/300		43.39
End cap (1 right + 1 left)			\$/ Set
	E / TV 60 + color*		4.73

***Color Codes**

 SP Sand pebble	 HB Light beige	 NB Nut brown	 FG Grout grey
 SG Stone grey	 HG Light grey	 GS Black	

* To complete the item number, add the color code (e.g., TVL 42 **GS** 90/200).

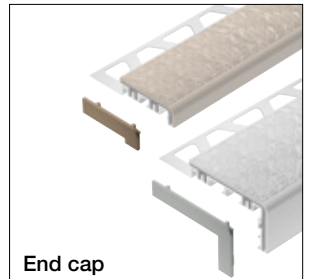
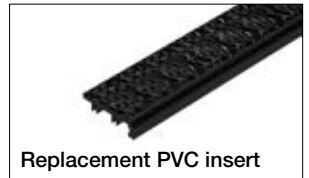



Schluter®-TREP-SE/-S/-B

Schluter®-TREP-SE/-S/-B are designed to protect tiled stair edges and provide an easily visible, slip-resistant wear surface for durable, safe, and visually appealing stair-nosing design. They are suitable for use in areas subjected to heavy foot-traffic, such as offices or public buildings. The profiles feature a trapezoid-perforated anchoring leg made of stainless steel (SE) or aluminum (-S and -B), with a slip-resistant, thermoplastic rubber wear surface. The tread surface is available in a variety of colors and can be replaced in case of damage or wear.

Note: Radius of leading edge for TREP-S and TREP-B: 8 mm - 5/16".

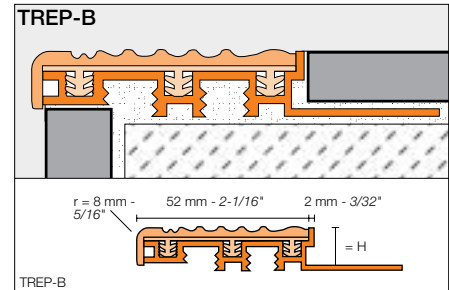
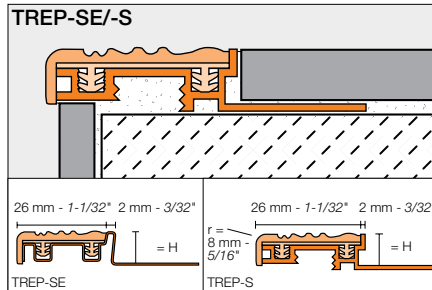
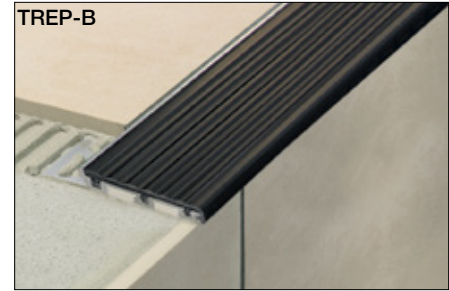
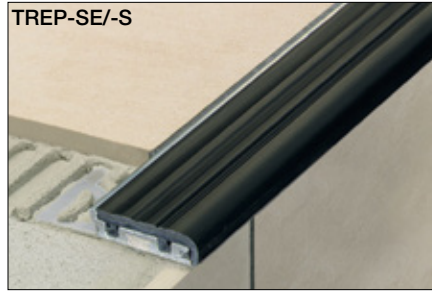

Schluter®-TREP-SE

Stainless steel support with thermoplastic rubber insert (26 mm - 1-1/32")

H = mm - in.	Item No.	\$ / Length
Length = 2.5 m - 8' 2-1/2"		
8 - 5/16	color* + 8 SE	78.34
10 - 3/8	color* + 10 SE	80.76
12.5 - 1/2	color* + 12 SE	84.08
Length = 1.50 m - 4' 11"		
8 - 5/16	color* + 8 SE/150	48.95
10 - 3/8	color* + 10 SE/150	50.48
12.5 - 1/2	color* + 12 SE/150	51.90

Stainless steel support section

H = mm - in.	Item No.	\$ / Length
Length = 2.5 m - 8' 2-1/2"		
8 - 5/16	TES 8	59.83
10 - 3/8	TES 10	62.22
12.5 - 1/2	TES 12	65.57
Length = 1.50 m - 4' 11"		
8 - 5/16	TES 8/150	40.60
10 - 3/8	TES 10/150	41.06
12.5 - 1/2	TES 12/150	42.13

Replacement thermoplastic rubber insert

Length = 2.5 m - 8' 2-1/2"		PE 26/+ color*	18.34
Length = 3 m - 9' 10"		PE 26/+ color*/300	22.93
End cap		\$ / Unit	
E 26/+ color*			1.73

***Color Codes**

Yellow	Light beige	Nut brown	Grey	Black

* To complete the item number, add the color code (e.g., G 10 SE).

Schluter®-TREP-S

Aluminum support with thermoplastic rubber insert (26 mm - 1-1/32")

H = mm - in.	Item No.	\$ / Length
Length = 2.5 m - 8' 2-1/2"		
8 - 5/16	color* + 8 S	52.35
10 - 3/8	color* + 10 S	54.37
12.5 - 1/2	color* + 12 S	57.78
Length = 1.50 m - 4' 11"		
8 - 5/16	color* + 8 S/150	33.38
10 - 3/8	color* + 10 S/150	33.99
12.5 - 1/2	color* + 12 S/150	36.09

Aluminum support section

H = mm - in.	Item No.	\$ / Length
Length = 2.5 m - 8' 2-1/2"		
8 - 5/16	TAS 8	34.55
10 - 3/8	TAS 10	36.56
12.5 - 1/2	TAS 12	39.95
Length = 1.50 m - 4' 11"		
8 - 5/16	TAS 8/150	17.30
10 - 3/8	TAS 10/150	18.28
12.5 - 1/2	TAS 12/150	19.99

Replacement thermoplastic rubber insert

Length = 2.5 m - 8' 2-1/2"		PEA 26/+ color*	18.34
Length = 3 m - 9' 10"		PEA 26/+ color*/300	22.93
Length = 15 m - 50'		PEA 26/+ color*/50	114.65
End cap		\$ / Unit	
E 26/+ color*			1.73

End cap (E26/ or E52/)

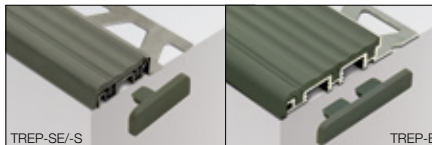

Schluter®-TREP-B

Aluminum support with thermoplastic rubber insert (52 mm - 2-1/16")

H = mm - in.	Item No.	\$ / Length
Length = 2.5 m - 8' 2-1/2"		
8 - 5/16	color* + 8 B	76.00
10 - 3/8	color* + 10 B	80.63
12.5 - 1/2	color* + 12 B	84.15
15 - 9/16	color* + 15 B	88.79
25 - 1	color* + 25 B	90.79

Aluminum support section

H = mm - in.	Item No.	\$ / Length
Length = 2.5 m - 8' 2-1/2"		
8 - 5/16	color* + 8 B/150	47.51
10 - 3/8	color* + 10 B/150	50.39
12.5 - 1/2	color* + 12 B/150	52.57
15 - 9/16	color* + 15 B/150	55.49
25 - 1	color* + 25 B/150	56.77

Aluminum support section

H = mm - in.	Item No.	\$ / Length
Length = 2.5 m - 8' 2-1/2"		
8 - 5/16	TAB 8	47.19
10 - 3/8	TAB 10	51.82
12.5 - 1/2	TAB 12	55.33
15 - 9/16	TAB 15	59.98
25 - 1	TAB 25	61.99

Replacement thermoplastic rubber insert

Length = 2.5 m - 8' 2-1/2"		PEA 52/+ color*	29.67
Length = 3 m - 9' 10"		PEA 52/+ color*/ 300	37.09
Length = 15 m - 50'		PEA 52/+ color*/ 50	185.55
End cap		\$ / Unit	
E 52/+ color*			2.14



Schluter®-TREP-TAP

Schluter®-TREP-TAP is an anodized aluminum cover profile that integrates with the Schluter®-TREP-S/-B stair-nosing profiles (page 68) to conceal the top of the riser. There are two options available: a 2-13/32" (61 mm) version featuring horizontal grooves, and a 2" (50 mm) version with a smooth surface finish.

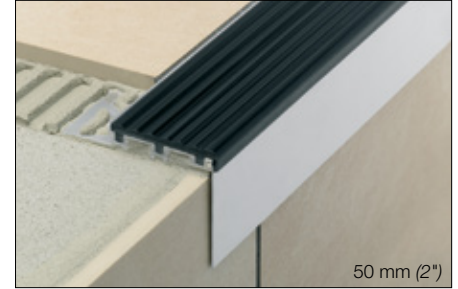
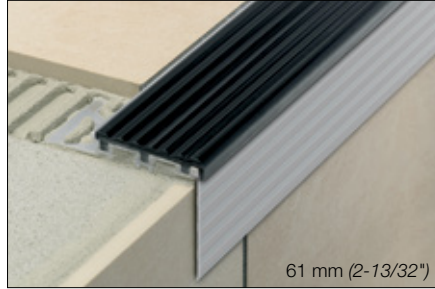

Schluter®-TREP-TAP	
Satin anodized aluminum (AE)	
Item No.	\$ / Length
50 mm - 2" Smooth	
Length = 2.5 m - 8' 2-1/2"	
TAP 50 AE	34.27
Length = 1.50 m - 4' 11"	
TAP 50 AE/150	21.58
Length = 1.00 m - 3' 3"	
TAP 50 AE/100	15.87
61 mm - 2-13/32" Grooved	
Length = 2.5 m - 8' 2-1/2"	
TAPR 61 AE	35.24
Length = 1.50 m - 4' 11"	
TAPR 61 AE/150	21.50

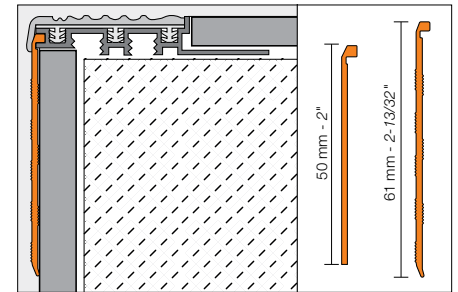

Schluter®-TREP-E (page 65)



Safety can be retrofitted

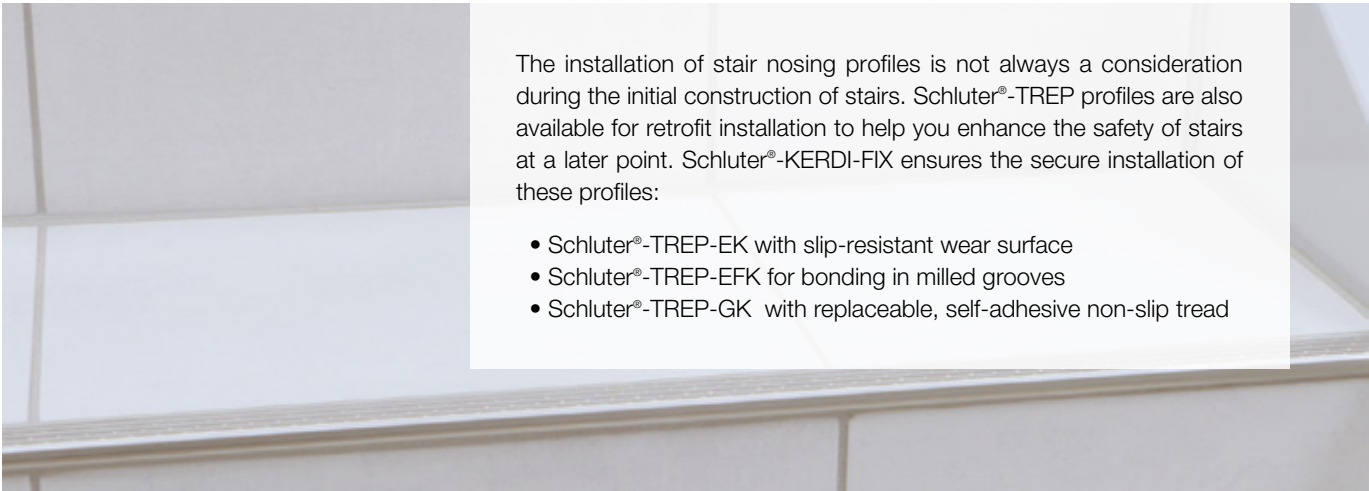

The installation of stair nosing profiles is not always a consideration during the initial construction of stairs. Schluter®-TREP profiles are also available for retrofit installation to help you enhance the safety of stairs at a later point. Schluter®-KERDI-FIX ensures the secure installation of these profiles:

- Schluter®-TREP-EK with slip-resistant wear surface
- Schluter®-TREP-EFK for bonding in milled grooves
- Schluter®-TREP-GK with replaceable, self-adhesive non-slip tread

Schluter®-TREP-EK

Schluter®-TREP-EK is designed to protect tiled stair edges and provide an easily visible, slip-resistant wear surface for durable, safe, and visually appealing stair-nosing design. The profile is made of stainless steel with an integrated slip-resistant wear surface, making it suitable for interior and exterior use in areas subjected to heavy foot-traffic, such as offices or public buildings.

TREP-EK is subsequently bonded to existing installations. As such, TREP-EK can be installed as a repair so that existing, damaged stair treads do not have to be replaced.

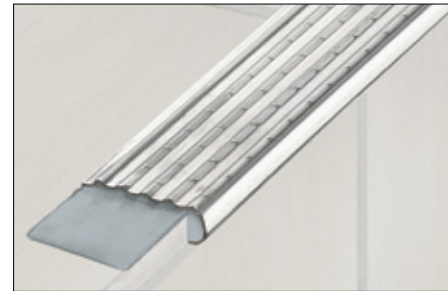
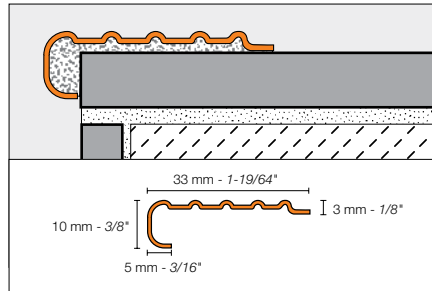

Schluter®-TREP-EK	
Stainless steel 304 (1.4301 = V2A) (E)	
Item No.	\$ / Length
Length = 2.5 m - 8' 2-1/2"	
TEK	53.79
Length = 1.50 m - 4' 11"	
TEK/150	32.27

Schluter®-TREP-EFK

Schluter®-TREP-EFK is a retrofit stainless steel stair profile which is bonded to existing steps. The stair profile features an easily visible, slip-resistant wear surface for durable and safe stairs. The profile is suitable for interior and exterior use in areas subjected to heavy foot traffic, such as offices or public buildings.

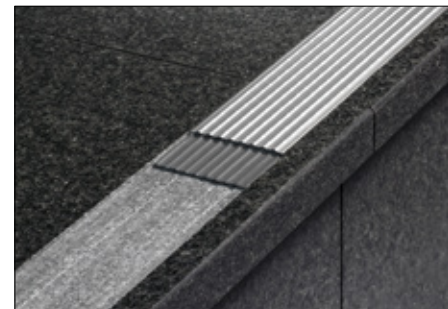
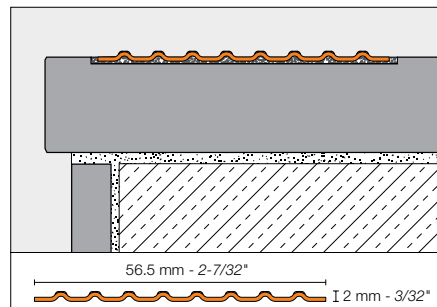

Schluter®-TREP-EFK	
Stainless steel 316L (1.4404 = V4A) (E)	
Item No.	\$ / Length
Length = 2.5 m - 8' 2-1/2"	
TEF56K/V4A	69.92



Schluter®-TREP-GK

Schluter®-TREP-GK is designed to protect tiled stair edges and provide an easily visible, slip-resistant wear surface for durable, safe, and visually appealing stair-nosing design. The profile is made of stainless steel, making it suitable for interior and exterior use in areas subjected to heavy foot-traffic, such as offices or public buildings. The surface features a self-adhesive, non-slip tread with an embedded mineral grain coating, which can be replaced in case of damage or wear.

TREP-GK is subsequently bonded to existing installations. As such, TREP-GK can be installed as a repair so that existing, damaged stair treads do not have to be replaced.

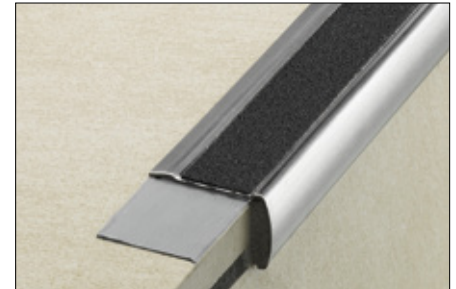
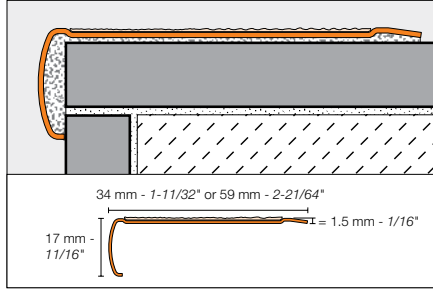

Schluter®-TREP-GK-S	
Brushed stainless steel support with non-slip tread (34 mm - 1-11/32")	
Item No.	\$ / Length
Length = 2.5 m - 8' 2-1/2"	
GS EBK + color*	116.85
Length = 1.50 m - 4' 11"	
GS EBK + color*/150	74.08
Replacement tread	
Length = 18.3 m - 60' 1/32"	
GS KB 183 + color*	152.27

Schluter®-TREP-GK-B	
Brushed stainless steel support with non-slip tread (59 mm - 2-21/64")	
Item No.	\$ / Length
Length = 2.5 m - 8' 2-1/2"	
GB EBK + color*	155.74
Length = 1.50 m - 4' 11"	
GB EBK + color*/150	98.07
Replacement tread	
Length = 18.3 m - 60' 1/32"	
GB KB 183 + color*	274.41

***Color Codes**



Transparent



Black

* To complete the item number, add the **color** code (e.g., GS EBK **GS**).



Schluter® Profiles

Movement joint & cove-shaped profiles

Movement joints are an integral part of any tile assembly and must be incorporated within the tile field at doorsills, and at transitions to walls and other restraining structures to allow movement of the assembly and prevent stresses that can damage the system. Schluter movement joint profiles protect tile edges and prevent sound bridges and surface water penetration, resulting in a permanent, maintenance-free installation.

Cove bases are a practical and hygienic method for treating floor-to-wall or wall-to-wall transitions, as they provide a curved surface that is easy to clean and prevent the accumulation of dirt. Schluter cove-shaped profiles provide an attractive, clean, and maintenance-free alternative for inside wall corners and floor/wall (including countertop/backsplash) transitions. Plus, they completely eliminate the need for caulk.





Schluter®-DILEX-MOP

Schluter®-DILEX-MOP is a screed joint profile with rigid PVC side sections that protect tile edges and a soft PVC movement zone that separates individual fields in the tile assembly and forms the visible surface. DILEX-MOP is designed to provide movement joints in tile installations that are set in a mortar bed (e.g., ceramic tile, natural stone, pavers, and agglomerate tile).

Note: Available only in grey.

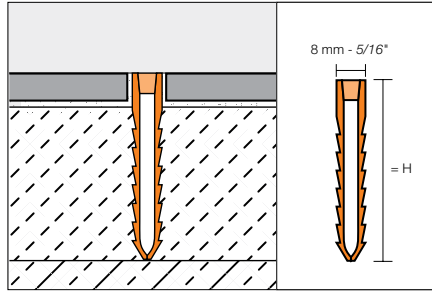

Schluter®-DILEX-MOP		
Length = 2.5 m - 8' 2-1/2"	Screed joint profile	
H = mm - in.	Item No.	\$/ Length
35 - 1-3/8	MOP 35 G	18.15
50 - 2	MOP 50 G	23.15
65 - 2-5/8	MOP 65 G	26.94

⚠ WARNING: Cancer www.P65Warnings.ca.gov

Schluter®-DILEX-MP/-MPV

Schluter®-DILEX-MP is a screed joint profile with rigid PVC side sections that protect tile edges and a soft chlorinated polyethylene (CPE) movement zone that separates individual fields in the tile assembly and forms the visible surface. The movement zone is available in different colors to match the grout. DILEX-MP is designed to provide movement joints in tile installations that are set in a mortar bed (e.g., ceramic tile, natural stone, pavers, and agglomerate tile). DILEX-MP adjusts to the thickness of the mortar bed and tile surface by attaching the DILEX-MPV extensions.

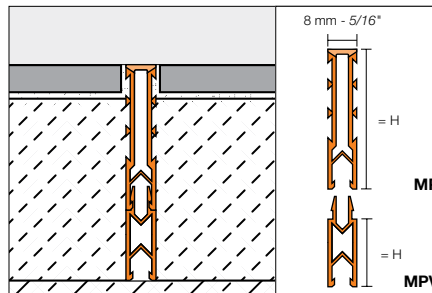

*Color Codes



* To complete the item number, add the **color** code (e.g., MP 35 **G**).

Schluter®-DILEX-MP		
Length = 2.5 m - 8' 2-1/2"	Screed joint profile	
H = mm - in.	Item No.	\$/ Length
35 - 1-3/8	MP 35 + color*	21.36

Schluter®-DILEX-MPV		
Length = 2.5 m - 8' 2-1/2"	Extension profile	
H = mm - in.	Item No.	\$/ Length
15 - 9/16	MPV 15	14.44
25 - 1	MPV 25	15.53

Schluter®-DILEX-EZ 6 + 9

Schluter®-DILEX-EZ 6 and 9 combine decorative design with stress-relieving function for tile and stone set in a thin bed of adhesive. The profile features two usable surfaces in different colors. The sidewalls are made of rigid PVC; the movement zones are made of soft PVC.

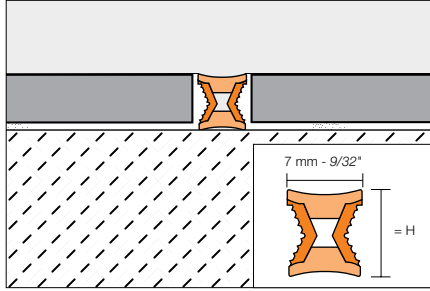

***Color Codes**

G Grey
CG Yellow

M/G = Brass inlay / grey
C/CG = Chrome inlay / yellow

Schluter®-DILEX-EZ 6 + 9			
Length = 2.5 m - 8' 2-1/2"	Decorative movement joint		
H = mm - in.	Item No.		\$ / Length
6 - 1/4	EZ M/G 6		17.35
6 - 1/4	EZ C/CG 6		17.35
9 - 11/32	EZ M/G 9		20.65
9 - 11/32	EZ C/CG 9		20.65

⚠ WARNING: Cancer and Reproductive Harm - www.P65Warnings.ca.gov

Schluter®-DILEX-BWS

Schluter®-DILEX-BWS is a surface joint profile with rigid PVC anchoring legs that protect tile edges and a 3/16" (5 mm)-wide, soft CPE movement zone that separates individual fields in the tile covering and forms the visible surface. The movement zone is available in different colors to match the grout. The profile absorbs relatively limited movements and may be installed with greater frequency to create smaller fields, or the Schluter®-DILEX-BWB (3/8" - 10 mm movement zone) may be used. DILEX-BWS is suitable for residential to medium-duty commercial applications subject to light mechanical loads (e.g., offices and stores). The profile is also suited for exterior use.

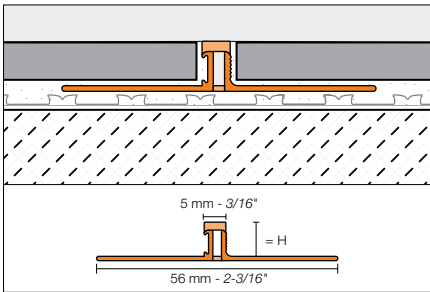

***Color Codes**

BW Bright white
SP Sand pebble
HB Light beige
PG Classic grey
G Grey

C Cream
SG Stone grey
FG Grout grey
DA Dark anthracite
GS Black

* To complete the item number, add the **color** code (e.g., BWS 80 **G**).

Schluter®-DILEX-BWS			
Length = 2.5 m - 8' 2-1/2"	PVC surface joint profile (5 mm - 3/16")		
H = mm - in.	Item No.		\$ / Length
4.5 - 3/16	BWS 45 + color*		19.00
6 - 1/4	BWS 60 + color*		19.00
8 - 5/16	BWS 80 + color*		19.00
9 - 11/32	BWS 90 + color*		19.97
10 - 3/8	BWS 100 + color*		19.97
11 - 7/16	BWS 110 + color*		19.97
12.5 - 1/2	BWS 125 + color*		19.97



Schluter®-DILEX-BWB

Schluter®-DILEX-BWB is a surface joint profile with rigid PVC anchoring legs that protect tile edges and a 3/8" (10 mm)-wide, soft CPE movement zone that separates individual fields in the tile covering and forms the visible surface. The movement zone is available in different colors to match the grout. DILEX-BWB is suitable for residential to medium-duty commercial applications subject to light mechanical loads (e.g., offices and stores). The profile is also suited for exterior use.

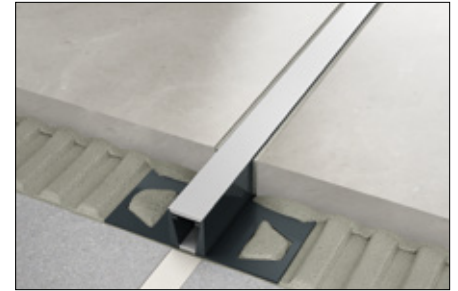
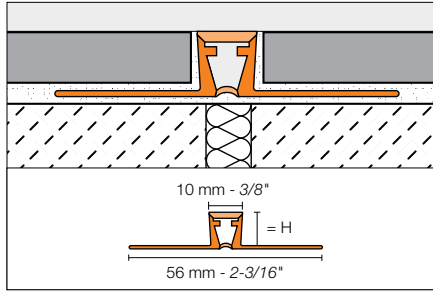

***Color Codes**

BW Bright white	SP Sand pebble	HB Light beige	PG Classic grey	G Grey
C Cream	SG Stone grey	FG Grout grey	DA Dark anthracite	GS Black

* To complete the item number, add the **color** code (e.g., BWB 80 **G**).

** BWB 60 is not available in sand pebble (SP).

Schluter®-DILEX-BWB			
Length = 2.5 m - 8' 2-1/2"		PVC surface joint profile (10 mm - 3/8")	
H = mm - in.		Item No.	\$/ Length
6 - 1/4		BWB 60 + color**	20.52
8 - 5/16		BWB 80 + color*	21.05
10 - 3/8		BWB 100 + color*	22.04
12.5 - 1/2		BWB 125 + color*	22.04
15 - 9/16		BWB 150 G (Grey only)	25.53
20 - 3/4		BWB 200 G (Grey only)	27.33

Schluter®-DILEX-F

Schluter®-DILEX-F is a surface joint profile with rigid, recycled PVC anchoring legs and a narrow replaceable silicone inlay that ties together tile fields to form a seamless visible surface. The carrier profile (DILEX-FCS) has a protective cover that is removed after tile installation and replaced with the selected color of silicone insert (DILEX-FIS). The trapezoid-perforated anchoring legs transfer movement to the profile movement zone. The special silicone inlay is equipped with anti-stretch properties and a low-friction coating that repels dust. The inlay is approximately 1/8" (3.5 mm) wide when installed and available in 10 colors to match the grout. The DILEX-F system is suitable for residential to medium-duty commercial applications subject to light mechanical loads (e.g., offices and stores).

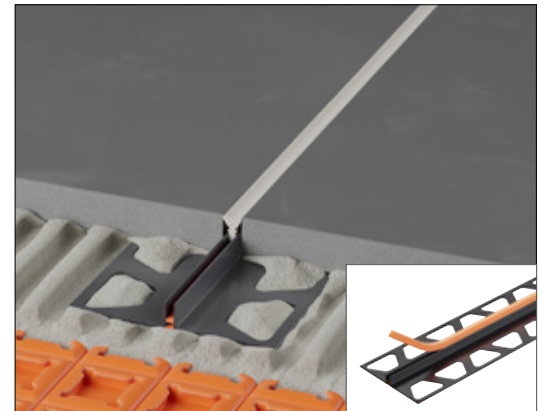
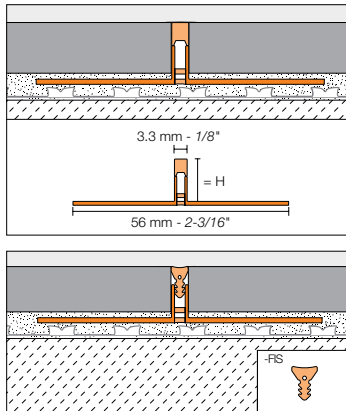

Schluter®-DILEX-FCS			
Length = 2.5 m - 8' 2-1/2"		Carrier profile with protective cover	
H = mm - in.		Item No.	\$/ Length
9 - 11/32		FCS 90	13.00
10 - 3/8		FCS 100	13.00
11 - 7/16		FCS 110	13.00
12.5 - 1/2		FCS 125	13.00

***Color Codes**

BW Bright white	SP Sand pebble	HB Light beige	PG Classic grey	G Grey
C Cream	SG Stone grey	FG Grout grey	DA Dark anthracite	GS Black

* To complete the item number, add the **color** code (e.g., FIS 300 **G**).

Schluter®-DILEX-FIS		
Silicone inlay		
Length = 31 m - 100'		
Item No.		\$/ Length
FIS 300 + color*		253.99



An installation tool is included with each roll of silicone inlay to facilitate cleaning of the joint and insertion of the inlay.

Schluter®-DILEX-KSN

Schluter®-DILEX-KSN is a surface joint profile with stainless steel or aluminum anchoring legs that protect tile edges and a 7/16" (11 mm)-wide, soft thermoplastic rubber movement zone that separates individual fields in the tile covering and forms the visible surface. The movement zone is available in different colors to match the grout and can be replaced if damaged. DILEX-KSN in stainless steel offers secure edge protection for surfaces exposed to heavy-duty commercial traffic (e.g., warehouses, production facilities, or shopping malls).

Note: DILEX-KSN is also available in stainless steel 316L (1.4404 = V4A). Contact Customer Service for price and availability.

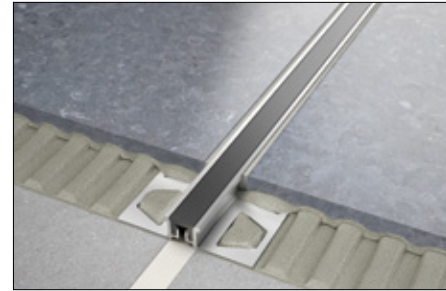
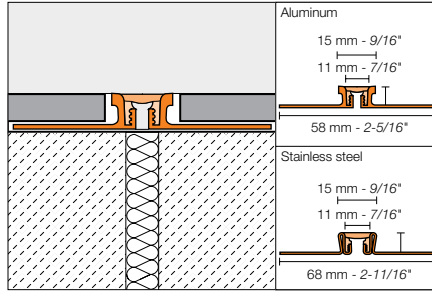

*Color Codes



* To complete the item number, add the **color** code (e.g., AKSN 125 **G**).

¹ The colors cream (C), stone grey (SG), grout grey (FG), and dark anthracite (DA) are only available in the following profile sizes:
EKSN sizes 100, 110, 125, 140, and 160
AKSN sizes 100, 110, and 125

Schluter®-DILEX-KSN

Length = 2.5 m - 8' 2-1/2"		Stainless steel 304 (1.4301 = V2A) (E)		Aluminum (A)	
H = mm - in.	Item No.	\$ / Length	Item No.	\$ / Length	
8 - 5/16	EKSN 80 + color*	98.27	AKSN 80 + color*	46.91	
10 - 3/8	EKSN 100 + color*	117.48	AKSN 100 + color*	48.95	
11 - 7/16	EKSN 110 + color*	120.41	AKSN 110 + color*	51.18	
12.5 - 1/2	EKSN 125 + color*	121.00	AKSN 125 + color*	50.99	
14 - 17/32	EKSN 140 + color*	123.09	AKSN 140 + color*	52.35	
16 - 5/8	EKSN 160 + color*	126.61	AKSN 160 + color*	54.37	
18.5 - 23/32	EKSN 185 + color*	129.42	-	-	
21 - 13/16	EKSN 210 + color*	132.94	AKSN 210 + color*	59.80	
25 - 1	EKSN 250 + color*	139.30	-	-	
30 - 1-3/16	EKSN 300 + color*	145.61	-	-	
Rubber insert replacement			KSE/ + color*		15.70

Schluter®-DILEX-AKWS

Schluter®-DILEX-AKWS is a surface joint profile with aluminum anchoring legs that protect tile edges and a 1/4" (6 mm)-wide, soft PVC movement zone that separates individual fields in the tile covering and forms the visible surface. The movement zone is available in different colors to match the grout. DILEX-AKWS is suitable for residential to medium-duty commercial applications, such as areas subject to moderate mechanical stresses, including light vehicular traffic.

An adhesive strip on the back of the profile ensures that the movement zone remains free of mortar during installation.

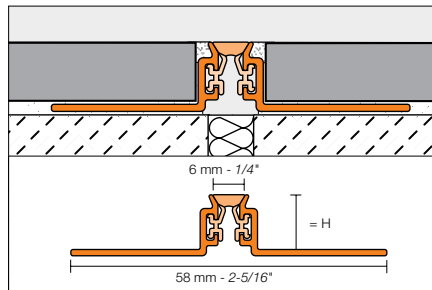

Schluter®-DILEX-AKWS

Length = 2.5 m - 8' 2-1/2"		Aluminum (A)	
H = mm - in.	Item No.	\$ / Length	
8 - 5/16	AKWS 80 + color*	34.66	
9 - 11/32	AKWS 90 + color*	36.68	
10 - 3/8	AKWS 100 + color*	37.40	
11 - 7/16	AKWS 110 + color*	38.05	
12.5 - 1/2	AKWS 125 + color*	40.14	
14 - 17/32	AKWS 140 + color*	43.50	
16 - 5/8	AKWS 160 + color*	46.22	
21 - 13/16	AKWS 210 + color*	50.29	

*Color codes



* To complete the item number, add the **color** code (e.g., AKWS 80 **G**).



Schluter®-DILEX-EKSB

Schluter®-DILEX-EKSB is a surface joint profile for thinner floor coverings (e.g., VCT flooring or coatings) with stainless steel anchoring legs and a 1/4" (6 mm)-wide, soft thermoplastic rubber movement zone that separates individual fields in the floor covering and forms the visible surface. The movement zone is available in different colors. DILEX-EKSB is suitable for residential to medium-duty commercial applications.

Note: DILEX-EKSB is also available in stainless steel 316L (1.4404 = V4A). Contact Customer Service for price and availability.

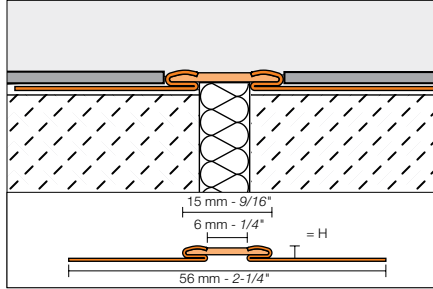

***Color Codes**

HB Light beige	PG Classic grey	G Grey	GS Black
--------------------------	---------------------------	------------------	--------------------

* To complete the item number, add the **color** code (e.g., EKSB 60 **G**).

Schluter®-DILEX-EKSB		
Length = 2.5 m - 8' 2-1/2"	Stainless steel 304 (1.4301 = V2A) (E)	
H = mm - in.	Item No.	\$/ Length
2.5 - 3/32	EKSB 25 + color*	86.20
4.5 - 3/16	EKSB 45 + color*	91.16
6 - 1/4	EKSB 60 + color*	94.74

Schluter®-DILEX-EDP

Schluter®-DILEX-EDP is a stainless steel surface joint profile that protects tile edges and separates individual fields in the tile covering. The profile accommodates horizontal movement via the 15/32" (12 mm)-wide stainless steel tongue-and-groove connection, which also forms the visible surface. DILEX-EDP is particularly suited for tile surfaces subject to heavy use, including areas exposed to continuous vehicular traffic. The profile is, therefore, suited for use in production facilities, warehouses, shopping centers, and underground parking garages, or for floor surfaces maintained with cleaning machines.

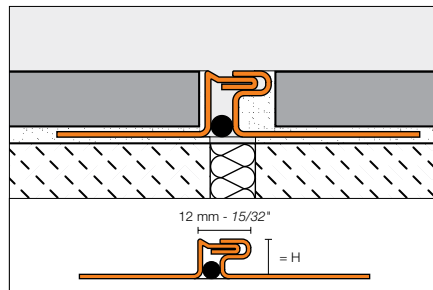

Schluter®-DILEX-EDP		
Length = 2.5 m - 8' 2-1/2"	Stainless steel 304 (1.4301 = V2A) (E)	
H = mm - in.	Item No.	\$/ Length
8 - 5/16	EDP 80	107.34
9 - 11/32	EDP 90	108.87
10 - 3/8	EDP 100	109.99
11 - 7/16	EDP 110	110.99
12.5 - 1/2	EDP 125	112.97
14 - 17/32	EDP 140	114.50
16 - 5/8	EDP 160	117.22
18.5 - 23/32	EDP 185	120.02
21 - 13/16	EDP 210	122.71
25 - 1	EDP 250	127.77
30 - 1-3/16	EDP 300	133.50

Schluter®-DILEX-BT

Schluter®-DILEX-BT is an expansion joint profile made of anodized aluminum that bridges expansion joints and accommodates movement via the 1-3/16" (30 mm)-wide telescopic center section, which also forms the visible surface. DILEX-BT protects tile edges and is suitable for tile surfaces exposed to foot traffic as well as vehicular traffic and is, therefore, suited for use in warehouses, production facilities, shopping centers, airports, train stations, and parking garages, or for coverings cleaned with machines.

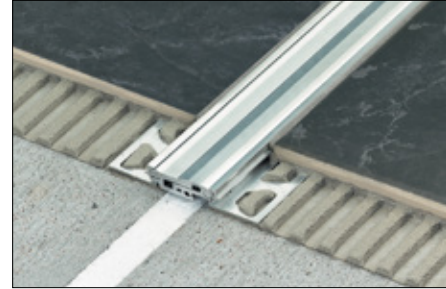
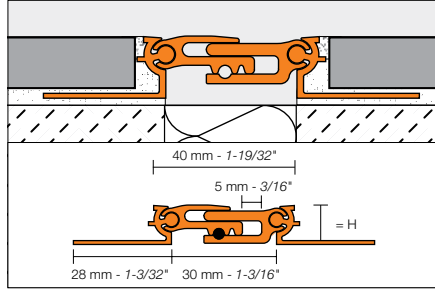

Schluter®-DILEX-BT		
Length = 2.5 m - 8' 2-1/2"	Satin anodized aluminum (AE)	
H = mm - in.	Item No.	\$ / Length
8 - 5/16	AEBT 80	158.07
10 - 3/8	AEBT 100	160.70
12.5 - 1/2	AEBT 125	163.73
15 - 9/16	AEBT 150	166.38
17.5 - 11/16	AEBT 175	169.72
20 - 3/4	AEBT 200	178.32

Schluter®-DILEX-BTO

Schluter®-DILEX-BTO is an expansion joint profile made of anodized aluminum that bridges expansion joints at floor/wall transitions and accommodates movement via the 1-3/16" (30 mm)-wide telescopic center section, which also forms the visible surface. DILEX-BTO protects tile edges and is suitable for tile surfaces exposed to foot traffic as well as vehicular traffic and is, therefore, suited for use in warehouses, production facilities, shopping centers, airports, train stations, and parking garages, or for coverings cleaned with machines.

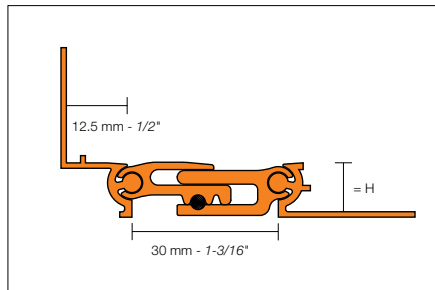

Schluter®-DILEX-BTO		
Length = 2.5 m - 8' 2-1/2"	Satin anodized aluminum (AE)	
H = mm - in.	Item No.	\$ / Length
8 - 5/16	AEBT 80/O 125	163.06
10 - 3/8	AEBT 100/O 125	164.31
12.5 - 1/2	AEBT 125/O 125	165.85
15 - 9/16	AEBT 150/O 125	167.22
17.5 - 11/16	AEBT 175/O 125	169.01
20 - 3/4	AEBT 200/O 125	173.17



Schluter®-DILEX-BTS

Schluter®-DILEX-BTS is an expansion joint profile made of anodized aluminum that bridges expansion joints and accommodates movement via the 1-3/16" (30 mm)-wide telescopic center section, which also forms the visible surface. The profile is installed in completed tile coverings. DILEX-BTS protects tile edges and is suitable for tile surfaces exposed to foot traffic as well as vehicular traffic and is, therefore, suited for use in warehouses, production facilities, shopping centers, airports, train stations, and parking garages, or for coverings cleaned with machines.

Note: DILEX-BTS can be inserted into existing joint spaces. The joints must be at least 1-3/4" (44 mm) wide and 3/8" (10 mm) deep.

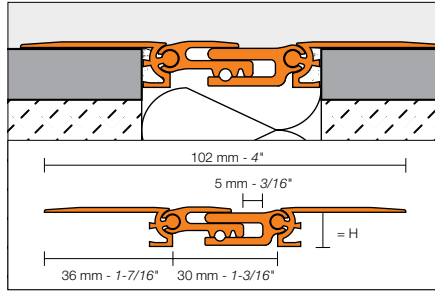

Schluter®-DILEX-BTS		
Length = 2.5 m - 8' 2-1/2"	Satin anodized aluminum (AE)	
H = mm - in.	Item No.	\$ / Length
10 - 3/8	AEBTS 100	163.73

Schluter®-DILEX-AS

Schluter®-DILEX-AS is a perimeter joint profile with a rigid PVC anchoring leg and a flexible joining leg with self-adhesive tape to bond the profile to fixed building elements (e.g., bathtubs, shower trays, door and window frames). DILEX-AS isolates the tile covering from the fixed building element and accommodates movement via the flexible joining leg, which also forms the visible surface. Suitable for tiles 3/16" to 3/8" (4 – 10 mm) thick.

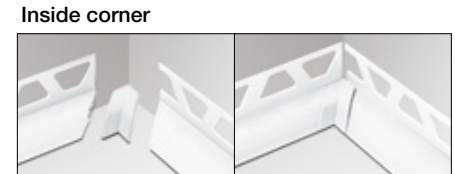
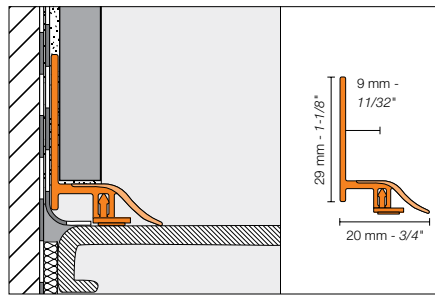

Schluter®-DILEX-AS								
Length = 2.5 m - 8' 2-1/2"	PVC perimeter joint profile Bright white (BW)							
H = mm - in.	Profile	\$ / Length	End cap (Right)	End cap (Left)	Inside corner	\$ / Unit	2 inside corners + 1 right end cap + 1 left end cap	\$ / Set
9 - 11/32	AS20BW	31.92	EKR/AS20BW	EKL/AS20BW	I/AS20BW	3.80	EKI/AS20BW	13.77

Schluter®-DILEX-BWA

Schluter®-DILEX-BWA is a perimeter joint profile with a rigid PVC anchoring leg and a 3/16" (5 mm)-wide, soft CPE movement zone that isolates the tile covering from fixed building elements (e.g., bathtubs, shower trays, door and window frames) and forms the visible surface. The movement zone is available in different colors to match the grout. The profile also features a dovetailed channel made of rigid PVC that can be bonded to the fixed building elements.

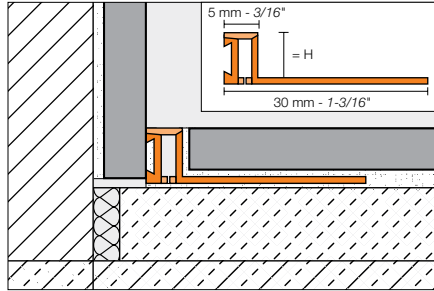

***Color Codes**

BW Bright white	SP Sand pebble	HB Light beige	PG Classic grey	G Grey
C Cream	SG Stone grey	FG Grout grey	DA Dark anthracite	GS Black

* To complete the item number, add the **color** code (e.g., BWA 80 **G**).
 ** BWA 45 is not available in Sand Pebble (SP)

Schluter®-DILEX-BWA			
Length = 2.5 m - 8' 2-1/2"	PVC perimeter joint profile		
H = mm - in.	Item No.	\$ / Length	
4.5 - 3/16	BWA 45 + color**	20.39	
6 - 1/4	BWA 60 + color*	21.74	
8 - 5/16	BWA 80 + color*	23.11	
10 - 3/8	BWA 100 + color*	23.79	
12.5 - 1/2	BWA 125 + color*	24.47	

Schluter®-DILEX-KSA

Schluter®-DILEX-KSA is a perimeter joint profile with a stainless steel or aluminum anchoring leg and a 3/8" (10 mm)-wide, soft thermoplastic rubber movement zone that isolates the tile covering from fixed building elements (e.g., window and door frames). The movement zone is available in different colors to match the grout and can be replaced if damaged. The profile also features a self-adhesive strip that allows it to bond to the fixed building elements.

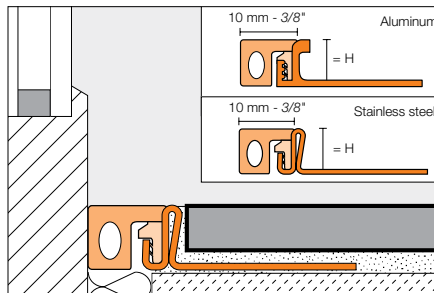

Note: DILEX-KSA is also available in stainless steel 316L (1.4404 = V4A). Contact Customer Service for price and availability.

Schluter®-DILEX-KSA					
Length = 2.5 m - 8' 2-1/2"	Stainless steel 304 (1.4301 = V2A) (E)			Aluminum (A)	
H = mm - in.	Item No.	\$ / Length	Item No.	\$ / Length	
8 - 5/16	EKSA 80 + color*	68.41	AKSA 80 + color*	38.09	
10 - 3/8	EKSA 100 + color*	83.37	AKSA 100 + color*	39.12	
11 - 7/16	EKSA 110 + color*	85.46	AKSA 110 + color*	40.09	
12.5 - 1/2	EKSA 125 + color*	85.88	AKSA 125 + color*	40.43	
14 - 17/32	EKSA 140 + color*	87.35	AKSA 140 + color*	42.24	
16 - 5/8	EKSA 160 + color*	89.86	-	-	
18.5 - 23/32	EKSA 185 + color*	91.86	-	-	
21 - 13/16	EKSA 210 + color*	94.35	-	-	
25 - 1	EKSA 250 + color*	98.87	-	-	
30 - 1-3/16	EKSA 300 + color*	103.37	-	-	
Rubber insert replacement			KSAE/+ color*		16.83

***Color Codes**

HB Light beige	PG Classic grey	G Grey	GS Black
--------------------------	---------------------------	------------------	--------------------

* To complete the item number, add the **color** code (e.g., EKSA 80 **G**).



Schluter®-DILEX-EKE

Schluter®-DILEX-EKE is a corner movement joint profile with rigid PVC anchoring legs and a 3/16" (5 mm)-wide, soft CPE movement zone that separates individual tile fields at floor/wall transitions and inside wall corners and forms the visible surface. The movement zone is available in different colors to match the grout and forms a discreet, uniform joint. DILEX-EKE prevents surface water penetration and prevents sound bridges, making it ideal for floor/wall transitions in sound-rated floors.

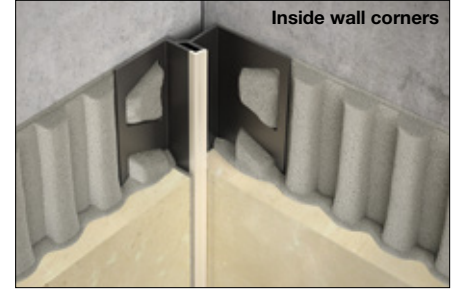
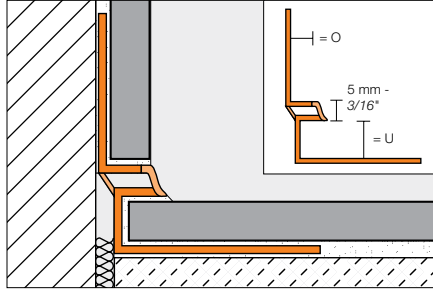

***Color Codes**

Bright white	Sand pebble	Light beige	Classic grey	Grey
Black				

* To complete the item number, add the **color** code (e.g., EKE U 8 / O 7 **BW**).

Schluter®-DILEX-EKE		\$ / Length
Corner movement profile		
Length = 2.5 m - 8' 2-1/2"		
U = floor or wall, O = wall		
EKE U 8/O 7	+ color*	19.45
EKE U 9/O 8	+ color*	19.97
EKE U 11/O 10	+ color*	20.11
EKE U 13/O 12	+ color*	20.58
EKE U 15/O 14	+ color*	21.22



U: 8 mm = 5/16"	9 mm = 11/32"	11 mm = 7/16"	13 mm = 33/64"	15 mm = 9/16"
O: 7 mm = 9/32"	8 mm = 5/16"	10 mm = 3/8"	12 mm = 1/2"	14 mm = 17/32"

Get perfect cuts!

Schluter®-SNIPS for PVC profiles. See page 188 for more information.



Floor: Schluter®-DILEX-EKE in sand pebble
Wall: Schluter®-QUADEC in cream (page 39)

Schluter®-DILEX-HKW

Schluter®-DILEX-HKW is a PVC cove-shaped profile for inside wall corners and floor/wall transitions in applications where limited movement is expected. The profile provides an 11/16" (18 mm) radius to prevent the accumulation of dirt and makes cleaning simple. DILEX-HKW accommodates wall and floor tiles that are of the same thickness. DILEX-HKW prevents surface water penetration and meets the maintenance and hygienic requirements of commercial kitchens, bathrooms, food processing plants, or any tiled environment where a sanitary cove base is desired.

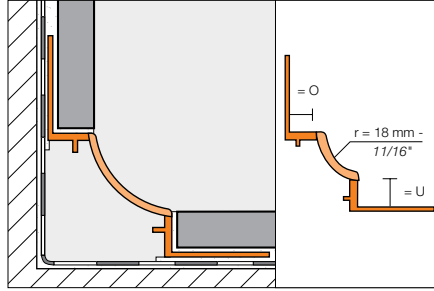

Outside corner (90°)

Inside corner, 3-way (90°)



Inside corner, 2-way (90°)

End cap

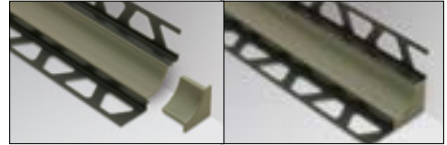
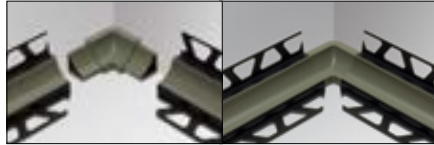

***Color Codes**



* To complete the item number, add the **color** code (e.g., HKW U 9 / O 9 **HB**).

U: 7 mm = 9/32" 9 mm = 11/32" 11 mm = 7/16"
O: 7 mm = 9/32" 9 mm = 11/32" 11 mm = 7/16"

Schluter®-DILEX-HKW

Length = 2.5 m - 8' 2-1/2" U = floor or wall, O = wall		Cove base profile				
Profile	\$/ Length	Outside corner, 90°	Inside corner, 90° (2-way)	Inside corner, 90° (3-way)	End cap	\$/ Unit
HKW U 7/O 7 + color *	25.94					
HKW U 9/O 9 + color *	25.94	A/HKW/+ color *	I/HKW 2 R18/+ color *	I/HKW 3 R18/+ color *	E/HKW/G (Grey only)	4.89
HKW U 11/O 11 + color *	25.94					



Schluter®-DILEX-HK

Schluter®-DILEX-HK is a cove-shaped profile with rigid PVC anchoring legs and a soft CPE movement zone that separates individual tile fields at floor/wall transitions and forms the visible surface. The profile provides an 11/16" (18 mm) radius to prevent the accumulation of dirt and makes cleaning simple. DILEX-HK accommodates wall and floor tiles of dissimilar thicknesses and features a tile pocket that hides cut tile edges. DILEX-HKW (page 82) integrates with DILEX-HK where cove trim is required for inside wall corners. DILEX-HK prevents surface water penetration and meets the maintenance and hygienic requirements of commercial kitchens, bathrooms, food processing plants, or any tiled environment where a sanitary cove base is desired. DILEX-HK also prevents sound bridges, making it ideal for floor/wall transitions in sound-rated floors.

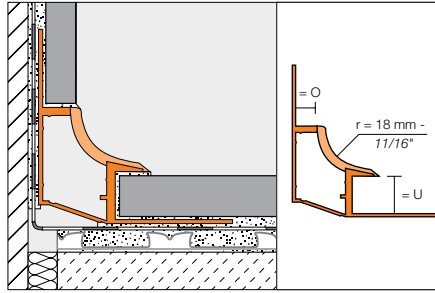

Outside corner (90°)

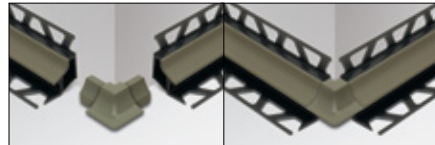

Connector



Inside corner, 2-way (90°)

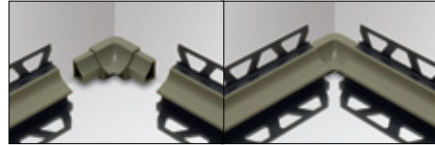

End cap (right or left)

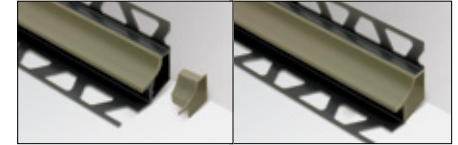

Inside corner, 3-way (90°)



Note: 3-way corners are to be used with DILEX-HKW (page 82) on the vertical.

***Color Codes**



* To complete the item number, add the **color** code (e.g., HK U 12 / O 9 **BW**).

U: 12 mm = 1/2"
O: 9 mm = 11/32"

Schluter®-DILEX-HK					
Length = 2.5 m - 8' 2-1/2" U = floor or wall, O = wall	Cove base profile				
Profile	\$ / Length	Outside corner, 90°	Inside corner, 90° (2-way)	Inside corner, 90° (3-way)	\$ / Unit
HK U 12/O 9 + color*	37.26	A/HK+ color*	I/HK 2 R18/+ color*	I/HK 3 R18/+ color*	4.89
Connector		V/HK			2.07
End cap (Left)		EL/HK/G (Grey only)			4.89
End cap (Right)		ER/HK/G (Grey only)			4.89



Schluter®-DILEX-AHK in dark anthracite (page 86)

Schluter®-DILEX-AHK

Schluter®-DILEX-AHK is a cove-shaped profile with a single trapezoid-perforated anchoring leg for inside wall corners, countertop/backsplash transitions and floor/wall transitions in applications where limited movement is expected. DILEX-AHK provides a 3/8" (10 mm) radius to prevent accumulation of dirt and makes cleaning simple. DILEX-AHK is available in anodized aluminum and textured color-coated aluminum. DILEX-AHK prevents surface water penetration and meets the maintenance and hygienic requirements of commercial kitchens, bathrooms, food processing plants, or any tiled environment where a sanitary cove base is desired.

Note: 90° outside corners are available in 2 configurations. The "round" corner (E90) features a rounded front that integrates with RONDEC, while the "square" corner (E90Q) features a square shaped front that integrates with QUADEC.

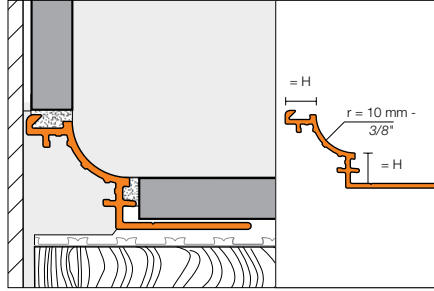

Outside corner, round (90° or 135°)



Inside corner (90° or 135°)

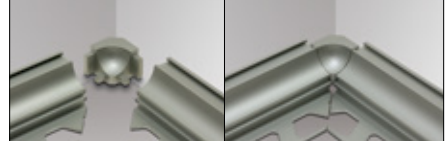

90° inside corners can be used 2-way or 3-way.

Outside corner, square (90°)

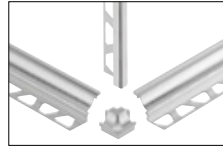

Connector

End cap

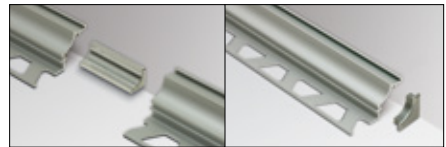

Schluter®-DILEX-AHK							
Length = 2.5 m - 8' 2-1/2"	Satin anodized aluminum (AE)						
H = mm - in.	Profile	\$ / Length	Outside corner, 90°	Outside corner, 135°	Inside corner, 90°	Inside corner, 135°	\$ / Unit
8 - 5/16	AHK 1S 80 AE	31.24	E 90/AHK 1S/AE	E 135/AHK 1S/AE	I 90/AHK 1S/AE	I 135/AHK 1S/AE	27.39
10 - 3/8	AHK 1S 100 AE	32.52					
12.5 - 1/2	AHK 1S 125 AE	34.01					
Outside corner square, 90°	E90 Q/AHK 1S/AE						26.55
Connector	V/AHK						4.63
End cap	E/AHK 1S/AE						16.42

Length = 2.5 m - 8' 2-1/2"	Polished chrome anod. alu. (ACG)						
H = mm - in.	Profile	\$ / Length	Outside corner, 90°	Outside corner, 135°	Inside corner, 90°	Inside corner, 135°	\$ / Unit
8 - 5/16	AHK 1S 80 ACG	54.12	E 90/AHK 1S/ACG	E 135/AHK 1S/ACG	I 90/AHK 1S/ACG	I 135/AHK 1S/ACG	31.55
10 - 3/8	AHK 1S 100 ACG	55.25					
12.5 - 1/2	AHK 1S 125 ACG	56.49					
Outside corner square, 90°	E90 Q/AHK 1S/ACG						30.98
Connector	V/AHK						4.63
End cap	E/AHK 1S/ACG						20.57

Length = 2.5 m - 8' 2-1/2"	Brushed chrome anod. alu. (ACGB)						
H = mm - in.	Profile	\$ / Length	Outside corner, 90°	Outside corner, 135°	Inside corner, 90°	Inside corner, 135°	\$ / Unit
8 - 5/16	AHK 1S 80 ACGB	48.42	E 90/AHK 1S/ACGB	E 135/AHK 1S/ACGB	I 90/AHK 1S/ACGB	I 135/AHK 1S/ACGB	31.55
10 - 3/8	AHK 1S 100 ACGB	49.76					
12.5 - 1/2	AHK 1S 125 ACGB	51.25					
Connector	V/AHK						4.63
End cap	E/AHK 1S/ACGB						20.57



Schluter®-DILEX-AHK							
Length = 2.5 m - 8' 2-1/2"	Satin nickel anod. alu. (AT)						
H = mm - in.	Profile	\$/ Length	Outside corner, 90°	Outside corner, 135°	Inside corner, 90°	Inside corner, 135°	\$/ Unit
8 - 5/16	AHK 1S 80 AT	36.13	E 90/AHK 1S/AT	E 135/AHK 1S/AT	I 90/AHK 1S/AT	I 135/AHK 1S/AT	27.39
10 - 3/8	AHK 1S 100 AT	37.46					
12.5 - 1/2	AHK 1S 125 AT	38.97					
15 - 9/16	AHK 1S 150 AT	40.46					
Outside corner square, 90°	E90 Q/AHK 1S/AT						26.55
Connector	V/AHK						4.63
End cap	E/AHK 1S/AT						16.42

Length = 2.5 m - 8' 2-1/2"	Polished nickel anod. alu. (ATG)						
H = mm - in.	Profile	\$/ Length	Outside corner, 90°	Outside corner, 135°	Inside corner, 90°	Inside corner, 135°	\$/ Unit
8 - 5/16	AHK 1S 80 ATG	57.20	E 90/AHK 1S/ATG	E 135/AHK 1S/ATG	I 90/AHK 1S/ATG	I 135/AHK 1S/ATG	31.55
10 - 3/8	AHK 1S 100 ATG	58.33					
12.5 - 1/2	AHK 1S 125 ATG	59.56					
Connector	V/AHK						
End cap	E/AHK 1S/ATG						20.57

Length = 2.5 m - 8' 2-1/2"	Brushed nickel anod. alu. (ATGB)						
H = mm - in.	Profile	\$/ Length	Outside corner, 90°	Outside corner, 135°	Inside corner, 90°	Inside corner, 135°	\$/ Unit
8 - 5/16	AHK 1S 80 ATGB	52.07	E 90/AHK 1S/ATGB	E 135/AHK 1S/ATGB	I 90/AHK 1S/ATGB	I 135/AHK 1S/ATGB	31.55
10 - 3/8	AHK 1S 100 ATGB	53.40					
12.5 - 1/2	AHK 1S 125 ATGB	54.89					
Connector	V/AHK						
End cap	E/AHK 1S/ATGB						20.57

Length = 2.5 m - 8' 2-1/2"	Satin copper anod. alu. (AK)						
H = mm - in.	Profile	\$/ Length	Outside corner, 90°	Outside corner, 135°	Inside corner, 90°	Inside corner, 135°	\$/ Unit
8 - 5/16	AHK 1S 80 AK	36.13	E 90/AHK 1S/AK	E 135/AHK 1S/AK	I 90/AHK 1S/AK	I 135/AHK 1S/AK	27.39
10 - 3/8	AHK 1S 100 AK	37.46					
12.5 - 1/2	AHK 1S 125 AK	38.97					
Connector	V/AHK						
End cap	E/AHK 1S/AK						16.42

Length = 2.5 m - 8' 2-1/2"	Polished copper anod. alu. (AKG)						
H = mm - in.	Profile	\$/ Length	Outside corner, 90°	Outside corner, 135°	Inside corner, 90°	Inside corner, 135°	\$/ Unit
8 - 5/16	AHK 1S 80 AKG	57.20	E 90/AHK 1S/AKG	E 135/AHK 1S/AKG	I 90/AHK 1S/AKG	I 135/AHK 1S/AKG	31.55
10 - 3/8	AHK 1S 100 AKG	58.33					
12.5 - 1/2	AHK 1S 125 AKG	59.56					
Connector	V/AHK						
End cap	E/AHK 1S/AKG						20.57

Length = 2.5 m - 8' 2-1/2"	Brushed copper anod. alu. (AKGB)						
H = mm - in.	Profile	\$/ Length	Outside corner, 90°	Outside corner, 135°	Inside corner, 90°	Inside corner, 135°	\$/ Unit
8 - 5/16	AHK 1S 80 AKGB	52.07	E 90/AHK 1S/AKGB	E 135/AHK 1S/AKGB	I 90/AHK 1S/AKGB	I 135/AHK 1S/AKGB	31.55
10 - 3/8	AHK 1S 100 AKGB	53.40					
12.5 - 1/2	AHK 1S 125 AKGB	54.89					
Connector	V/AHK						
End cap	E/AHK 1S/AKGB						20.57

Schluter®-DILEX-AHK							
Length = 2.5 m - 8' 2-1/2"	Satin brass anod. alu. (AM)						
H = mm - in.	Profile	\$ / Length	Outside corner, 90°	Outside corner, 135°	Inside corner, 90°	Inside corner, 135°	\$ / Unit
8 - 5/16	AHK 1S 80 AM	36.13	E 90/AHK 1S/AM	E 135/AHK 1S/AM	I 90/AHK 1S/AM	I 135/AHK 1S/AM	27.39
10 - 3/8	AHK 1S 100 AM	37.46					
12.5 - 1/2	AHK 1S 125 AM	38.97					
Connector	V/AHK						4.63
End cap	E/AHK 1S/AM						16.42

Schluter®-DILEX-AMG							
Length = 2.5 m - 8' 2-1/2"	Polished brass anod. alu. (AMG)						
H = mm - in.	Profile	\$ / Length	Outside corner, 90°	Outside corner, 135°	Inside corner, 90°	Inside corner, 135°	\$ / Unit
8 - 5/16	AHK 1S 80 AMG	55.74	E 90/AHK 1S/AMG	E 135/AHK 1S/AMG	I 90/AHK 1S/AMG	I 135/AHK 1S/AMG	31.55
10 - 3/8	AHK 1S 100 AMG	56.82					
12.5 - 1/2	AHK 1S 125 AMG	58.09					
Connector	V/AHK						4.63
End cap	E/AHK 1S/AMG						20.57

Schluter®-DILEX-AMGB							
Length = 2.5 m - 8' 2-1/2"	Brushed brass anod. alu. (AMGB)						
H = mm - in.	Profile	\$ / Length	Outside corner, 90°	Outside corner, 135°	Inside corner, 90°	Inside corner, 135°	\$ / Unit
8 - 5/16	AHK 1S 80 AMGB	50.32	E 90/AHK 1S/AMGB	E 135/AHK 1S/AMGB	I 90/AHK 1S/AMGB	I 135/AHK 1S/AMGB	31.55
10 - 3/8	AHK 1S 100 AMGB	51.63					
12.5 - 1/2	AHK 1S 125 AMGB	53.12					
Connector	V/AHK						4.63
End cap	E/AHK 1S/AMGB						20.57

Schluter®-DILEX-AGRB							
Length = 2.5 m - 8' 2-1/2"	Brushed graphite anod. alu. (AGRB)						
H = mm - in.	Profile	\$ / Length	Outside corner, 90°	Outside corner, 135°	Inside corner, 90°	Inside corner, 135°	\$ / Unit
8 - 5/16	AHK 1S 80 AGRB	52.07	E 90/AHK 1S/AGRB	E 135/AHK 1S/AGRB	I 90/AHK 1S/AGRB	I 135/AHK 1S/AGRB	31.55
10 - 3/8	AHK 1S 100 AGRB	53.40					
12.5 - 1/2	AHK 1S 125 AGRB	54.89					
15 - 9/16	AHK 1S 150 AGRB	56.55					
Connector	V/AHK						4.63
End cap	E/AHK 1S/AGRB						20.57

Schluter®-TRENDLINE Textured Color-coated Aluminum

Schluter®-TRENDLINE Textured Color-coated Aluminum (TS)							
Length = 2.5 m - 8' 2-1/2"	Textured color-coated aluminum (TS)						
H = mm - in.	Profile	\$ / Length	Outside corner, 90°	Outside corner, 135°	Inside corner, 90°	Inside corner, 135°	\$ / Unit
8 - 5/16	AHK 1S 80 + color*	54.62	E 90/AHK 1S/ + color*	E 135/AHK 1S/ + color*	I 90/AHK 1S/ + color*	I 135/AHK 1S/ + color*	33.10
10 - 3/8	AHK 1S 100 + color*	55.41					
12.5 - 1/2	AHK 1S 125 + color*	56.58					
15 - 9/16	AHK 1S 150 + color*	57.71					
Outside corner square, 90°	E90 Q/AHK 1S/+ color*						30.74
Connector	V/AHK						4.63
End cap	E/AHK 1S/+ color*						21.90

*Color Codes



* To complete the item number, add the color code (e.g., AHK 1S 80 TSB).



Schluter®-DILEX-AHKA

Schluter®-DILEX-AHKA is a cove-shaped profile for transitions between walls to be tiled and previously finished floors. DILEX-AHKA is available in anodized aluminum and textured color-coated aluminum. The profile features a single-trapezoid perforated anchoring leg that is secured in the mortar bond coat and a dovetailed channel, which can be bonded to floor surfaces using Schluter®-KERDI-FIX, epoxy resin, silicone, thin-set mortar, etc. A 3/8" (10 mm) radius cove section forms the visible surface and prevents the accumulation of dirt, making cleaning simple. DILEX-AHKA prevents surface water penetration and meets the maintenance and hygienic requirements of commercial kitchens, bathrooms, food processing plants, or any tiled environment where a sanitary cove base is desired. DILEX-AHKA integrates with the Schluter®-DILEX-AHK and Schluter®-RONDEC profiles at 90° inside and outside vertical wall corners, respectively.

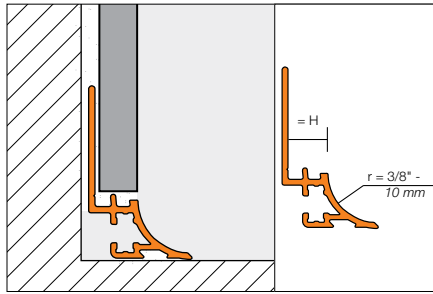

Outside corner (90° or 135°)

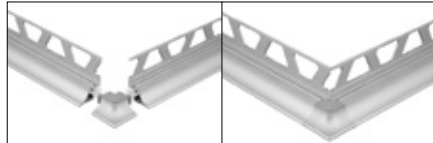

Inside corner (90° or 135°)

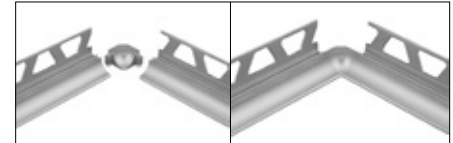

End cap



90° inside corners can be used 2-way, or 3-way when combined with DILEX-AHK on the vertical inside corner.

Schluter®-DILEX-AHKA							
Length = 2.5 m - 8' 2-1/2"		Satin anodized aluminum (AE)					
H = mm - in.	Profile	\$/ Length	Outside corner, 90°	Outside corner, 135°	Inside corner, 90°	Inside corner, 135°	\$/ Unit
8 - 5/16	AHKA 80 AE	31.24	E 90/AHKA/AE	E 135/AHKA/AE	I 90/AHKA/AE	I 135/AHKA/AE	27.39
10 - 3/8	AHKA 100 AE	32.52					
12.5 - 1/2	AHKA 125 AE	34.01					
15 - 9/16	AHKA 150 AE	35.02					
End cap (left)			EL/AHKA/AE				16.42
End cap (right)			ER/AHKA/AE				16.42

Length = 2.5 m - 8' 2-1/2"		Brushed chrome anod. alu. (ACGB)					
H = mm - in.	Profile	\$/ Length	Outside corner, 90°	Outside corner, 135°	Inside corner, 90°	Inside corner, 135°	\$/ Unit
8 - 5/16	AHKA 80 ACGB	48.42	E 90/AHKA/ACGB	E 135/AHKA/ACGB	I 90/AHKA/ACGB	I 135/AHKA/ACGB	31.55
10 - 3/8	AHKA 100 ACGB	49.76					
12.5 - 1/2	AHKA 125 ACGB	51.25					
15 - 9/16	AHKA 150 ACGB	52.80					
End cap (left)			EL/AHKA/ACGB				20.57
End cap (right)			ER/AHKA/ACGB				20.57

Length = 2.5 m - 8' 2-1/2"		Satin nickel anod. alu. (AT)					
H = mm - in.	Profile	\$/ Length	Outside corner, 90°	Outside corner, 135°	Inside corner, 90°	Inside corner, 135°	\$/ Unit
8 - 5/16	AHKA 80 AT	36.13	E 90/AHKA/AT	E 135/AHKA/AT	I 90/AHKA/AT	I 135/AHKA/AT	27.39
10 - 3/8	AHKA 100 AT	37.46					
12.5 - 1/2	AHKA 125 AT	38.97					
15 - 9/16	AHKA 150 AT	40.46					
End cap (left)			EL/AHKA/AT				16.42
End cap (right)			ER/AHKA/AT				16.42

Schluter®-DILEX-AHKA							
Length = 2.5 m - 8' 2-1/2"	Brushed nickel anod. alu. (ATGB)						
H = mm - in.	Profile	\$ / Length	Outside corner, 90°	Outside corner, 135°	Inside corner, 90°	Inside corner, 135°	\$ / Unit
8 - 5/16	AHKA 80 ATGB	52.07	E 90/AHKA/ATGB	E 135/AHKA/ATGB	I 90/AHKA/ATGB	I 135/AHKA/ATGB	31.55
10 - 3/8	AHKA 100 ATGB	53.40					
12.5 - 1/2	AHKA 125 ATGB	54.89					
15 - 9/16	AHKA 150 ATGB	56.55					
End cap (left)	EL/AHKA/ATGB						20.57
End cap (right)	ER/AHKA/ATGB						20.57

Schluter®-TRENDLINE Textured Color-coated Aluminum

Length = 2.5 m - 8' 2-1/2"	Textured color-coated aluminum (TS)						
H = mm - in.	Profile	\$ / Length	Outside corner, 90°	Outside corner, 135°	Inside corner, 90°	Inside corner, 135°	\$ / Unit
8 - 5/16	AHKA 80 + color*	54.62	E 90/AHKA/ + color*	E 135/AHKA/ + color*	I 90/AHKA/ + color*	I 135/AHKA/ + color*	33.10
10 - 3/8	AHKA 100 + color*	55.41					
12.5 - 1/2	AHKA 125 + color*	56.58					
15 - 9/16	AHKA 150 + color*	57.71					
End cap (left)	EL/AHKA/+ color*						21.36
End cap (right)	ER/AHKA/+ color*						21.36

*Color Codes

TSI	TSBG	TSSG	TSC	TSB	TSR	TSOB	TSG	TSLA	TSDA
Ivory	Greige	Stone grey	Cream	Beige	Rustic brown	Bronze	Pewter	Light anthracite	Dark anthracite

* To complete the item number, add the color code (e.g., AHKA 80 **TSB**).



Schluter®-DILEX-PHK

Schluter®-DILEX-PHK is a PVC, cove-shaped profile for inside wall corners, countertop/backsplash transitions and floor/wall transitions in applications where limited movement is expected. DILEX-PHK provides a 3/8" (10 mm) radius to prevent the accumulation of dirt and makes cleaning simple. DILEX-PHK prevents surface water penetration and meets the maintenance and hygienic requirements of commercial kitchens, bathrooms, food processing plants, or any tiled environment where a sanitary cove base is desired.

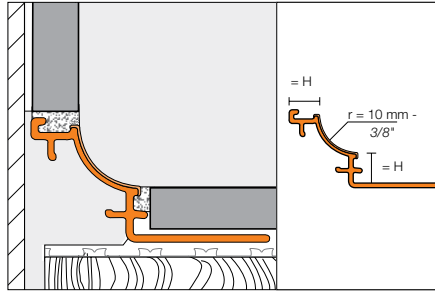

Outside corner (90° or 135°)

Inside corner (90° or 135°)



Connector

End cap



90° inside corners can be used 2-way or 3-way.

***Color Codes**



* To complete the item number, add the color code (e.g., PHK 1S 80 **BW**).

Schluter®-DILEX-PHK

Length = 2.5 m - 8' 2-1/2"		Cove base profile						
H = mm - in.	Profile	\$/ Length	Outside corner, 90°	Outside corner, 135°	Inside corner, 90°	Inside corner, 135°	\$/ Unit	
8 - 5/16	PHK 1S 80 + color*	22.95	E 90/PHK 1S/ + color*	E 135/PHK 1S/ + color*	I 90/PHK 1S/ + color*	I 135/PHK 1S/ + color*	3.27	
10 - 3/8	PHK 1S 100 + color*	24.20						
12.5 - 1/2	PHK 1S 125 + color*	24.55						
Connector	V/PHK						1.82	
End cap	E/PHK 1S/ + color*						3.27	

Schluter®-DILEX-EHK

Schluter®-DILEX-EHK is a stainless steel, cove-shaped profile for inside wall corners, countertop/backsplash transitions and floor/wall transitions in applications where limited movement is expected. DILEX-EHK provides a 23/32" (18.5 mm) radius to prevent the accumulation of dirt and makes cleaning simple. DILEX-EHK prevents surface water penetration and meets the maintenance and hygienic requirements of commercial kitchens, bathrooms, food processing plants, or any tiled environment where a sanitary cove base is desired.

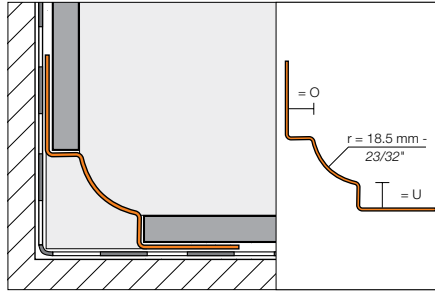

Outside corner (90° or 135°)

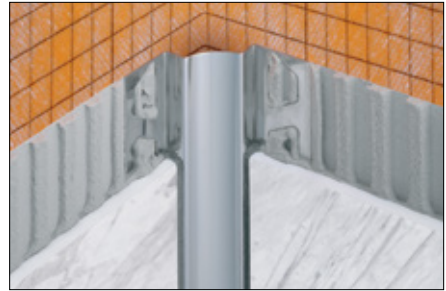

Inside corner, 3-way (90°)

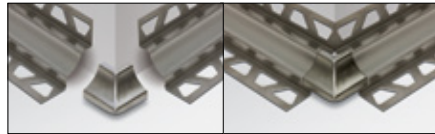

Inside corner, 2-way (90° or 135°)

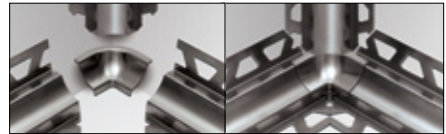

Connector

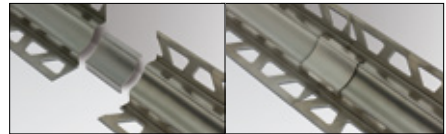
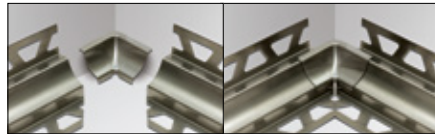

End cap

U:	7 mm = 9/32"	9 mm = 11/32"
	11 mm = 7/16"	16 mm = 5/8"
O:	7 mm = 9/32"	9 mm = 11/32"
	11 mm = 7/16"	16 mm = 5/8"

Schluter®-DILEX-EHK							
Stainless steel 304 (1.4301 = V2A) (E)	Stainless steel 316L (1.4404 = V4A) (EV4A)						
Length = 2.5 m - 8' 2-1/2" U = floor or wall, O = wall Profile	\$/ Length	Outside corner, 90°	Inside corner, 90° (2-way)	Inside corner, 90° (3-way)	Outside corner, 135°	Inside corner, 135°	\$/ Unit
EHK U 7/O 7	79.88	A/EHK 2 R18	I/EHK 2 R18	I/EHK 3 R18	E135/EHK2R18	I135/EHK2R18	9.39
EHK U 9/O 9	82.23						
EHK U 11/O 11	84.85						
Connector		V/EHK					9.39
End cap		E/HKW/G (Grey PVC only)					4.89

Stainless steel 316L (1.4404 = V4A) (EV4A)							
Length = 2.5 m - 8' 2-1/2" U = floor or wall, O = wall Profile	\$/ Length	Outside corner, 90°	Inside corner, 90° (2-way)	Inside corner, 90° (3-way)	Outside corner, 135°	Inside corner, 135°	\$/ Unit
EHK U 7/O 7/V4A	87.83	A/EHK 2 R18	I/EHK 2 R18	I/EHK 3 R18	E135/EHK 2 R18	I135/EHK 2 R18	9.39
EHK U 9/O 9/V4A	90.44						
EHK U 11/O 11/V4A	93.32						
EHK U 16/O 16/V4A	95.19						
Connector		V/EHK					9.39
End cap		E/HKW/G (Grey PVC only)					4.89

Brushed Stainless steel 304 (1.4301 = V2A) (EB)							
Brushed Stainless steel 316L (1.4404 = V4A) (EBV4A)							
Length = 2.5 m - 8' 2-1/2" U = floor or wall, O = wall Profile	\$/ Length	Outside corner, 90°	Inside corner, 90° (2-way)	Inside corner, 90° (3-way)	Outside corner, 135°	Inside corner, 135°	\$/ Unit
EBHK U 7/O 7	103.84	A/EBHK 2 R18	I/EBHK 2 R18	I/EBHK 3 R18	E135/EBHK2R18	I135/EBHK2R18	12.19
EBHK U 9/O 9	106.89						
EBHK U 11/O 11	110.29						
Connector		V/EBHK					12.19
End cap		E/HKW/G (Grey PVC only)					4.89



Schluter®-DILEX-HKS

Schluter®-DILEX-HKS is a stainless steel, cove-shaped profile for inside wall corners, and floor/wall transitions in applications. DILEX-HKS features a soft, thermoplastic rubber movement zone to absorb larger movements at floor/wall transitions and inside wall corners and a 23/32" (18.5 mm) radius to prevent the accumulation of dirt and makes cleaning simple. DILEX-HKS prevents surface water penetration and meets the maintenance and hygienic requirements of commercial kitchens, bathrooms, food processing plants, or any tiled environment where a sanitary cove base is desired.

Note: DILEX-HKS is also available in stainless steel 316L (1.4404 = V4A). Contact Customer Service for price and availability.

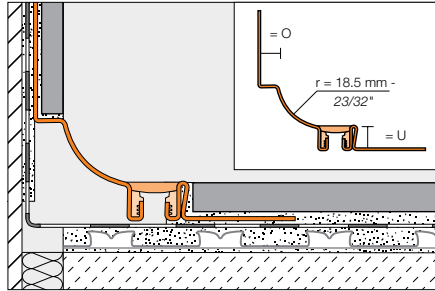

Outside corner (90°)



Inside corner, 2-way (90°)

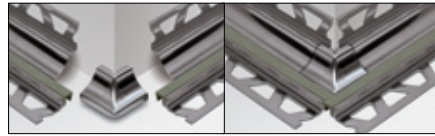

Inside corner, 3-way (90°)

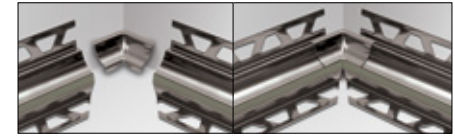

Connector

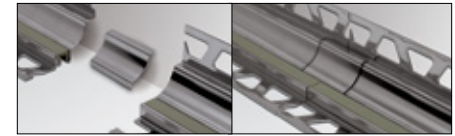
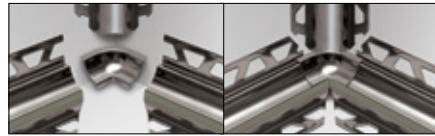

End cap

***Color Codes**



* To complete the item number, add the **color** code (e.g., HKS V2A U 18 / O 7 **G**).

U: 8 mm = 5/16"	10 mm = 3/8"	12 mm = 15/32"	14 mm = 17/32"	16 mm = 5/8"
18 mm = 23/32"	21 mm = 13/16"	25 mm = 1"	30 mm = 1-3/16"	
O: 7 mm = 9/32"	9 mm = 11/32"	11 mm = 7/16"		

Schluter®-DILEX-HKS	
Length = 2.5 m - 8' 2-1/2"	Stainless steel 304 (1.4301 = V2A) (E)
U = floor or wall, O = wall	
Profile	\$ / Length
HKS V2A U 8 / O 7 + color*	140.68
HKS V2A U 10 / O 7 + color*	142.08
HKS V2A U 12 / O 7 + color*	142.74
HKS V2A U 14 / O 7 + color*	144.81
HKS V2A U 16 / O 7 + color*	146.22
HKS V2A U 18 / O 7 + color*	146.91
HKS V2A U 21 / O 7 + color*	148.27
HKS V2A U 25 / O 7 + color*	151.02
HKS V2A U 30 / O 7 + color*	153.09
HKS V2A U 8 / O 9 + color*	140.68
HKS V2A U 10 / O 9 + color*	142.08
HKS V2A U 12 / O 9 + color*	142.74
HKS V2A U 14 / O 9 + color*	144.81
HKS V2A U 16 / O 9 + color*	146.22
HKS V2A U 18 / O 9 + color*	146.91
HKS V2A U 21 / O 9 + color*	148.27
HKS V2A U 25 / O 9 + color*	151.02
HKS V2A U 30 / O 9 + color*	153.09
HKS V2A U 8 / O 11 + color*	140.68
HKS V2A U 10 / O 11 + color*	142.08
HKS V2A U 12 / O 11 + color*	142.74
HKS V2A U 14 / O 11 + color*	144.81
HKS V2A U 16 / O 11 + color*	146.22
HKS V2A U 18 / O 11 + color*	146.91
HKS V2A U 21 / O 11 + color*	148.27
HKS V2A U 25 / O 11 + color*	151.02
HKS V2A U 30 / O 11 + color*	153.09

Schluter®-DILEX-HKS		
	Stainless steel 316L (1.4404 = V4A) (EV4A)	\$ / Unit
Outside corner, 90°	A/EHK 2 R18	9.39
Inside corner, 90° (2-way)	I/EHK 2 R18	9.39
Inside corner, 90° (3-way)	I/EHK 3 R18	9.39
Outside corner, 135°	E135/EHK2R18	9.39
Inside corner, 135°	I135/EHK2R18	9.39
Connector	V/EHK	9.39
End cap	E/HKW/G (Grey PVC only)	4.89

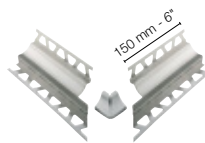

Note: 90° outside corners with pre-cut profile sections are available by special order only. Please contact Customer Service for availability.

Schluter®-DILEX-HKS		
	Stainless steel 304 (1.4301 = V2A) (E)	\$ / Unit
90° outside corner with pre-cut profile sections	E90 V2A U ... / O ... + color**	55.51
	Stainless steel 316L (1.4404 = V4A) (EV4A)	\$ / Unit
90° outside corner with pre-cut profile sections	E90 V4A U ... / O ... + color**	61.67

** To complete the item number, add the "U" and "O" values, and the **color** code (e.g., E90 V2A U 12 / O 9 **G**). Available for U = 8, 10, 12, 14 and 16 mm only.

Schluter®-DILEX-HKU

Schluter®-DILEX-HKU is a stainless steel, cove-shaped profile for inside wall corners and floor/wall (including countertop/backsplash) transitions. DILEX-HKU may be used with floor coverings other than ceramic and stone tile, provided the floor coverings are fastened or adhered (i.e., no floating floors). The profile features a single anchoring leg that turns inward, which allows it to be used with different thicknesses of tile. DILEX-HKU is available with either a 3/8" (10 mm) or 1-7/16" (36 mm) radius cove section. The cove section forms the visible surface and prevents the accumulation of dirt, making cleaning simple. DILEX-HKU prevents surface water penetration and meets the maintenance and hygienic requirements of commercial kitchens, bathrooms, and food processing plants, or any tiled environment where a sanitary cove base is desired.

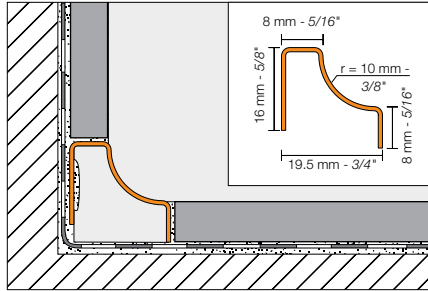

Outside corner (90° or 135°)

Inside corner (90° or 135°)

Connector

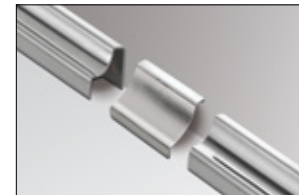
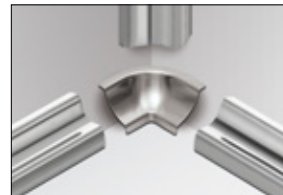
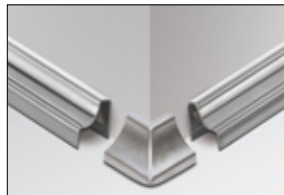

Schluter®-DILEX-HKU (10 mm - 3/8" radius)

Length = 2.5 m - 8' 2-1/2"	Stainless steel 304 (1.4301 = V2A) (E)		Stainless steel 316L (1.4404 = V4A) (EV4A)					
	Profile	\$ / Length	Outside corner 90°	Inside corner 90°	\$ / Unit	Outside corner 135°	Inside corner 135°	\$ / Unit
R = mm - in.								
10 - 3/8	HKUR 10 E	56.16	EQ/HKUR 10 E	I/HKU 3 R 10 E	6.39	E135/HKUR 10 E	I135/HKUR 10 E	6.10
Connector	V/HKUR 10 E							5.80
End cap	EK/HKUR 10 E							5.29

Length = 2.5 m - 8' 2-1/2"	Stainless steel 316L (1.4404 = V4A) (EV4A)							
	Profile	\$ / Length	Outside corner 90°	Inside corner 90°	\$ / Unit	Outside corner 135°	Inside corner 135°	\$ / Unit
R = mm - in.								
10 - 3/8	HKUR 10 E / V4A	84.17	EQ/HKUR 10 E	I/HKU 3 R 10 E	6.39	E135/HKUR 10 E	I135/HKUR 10 E	6.10
Connector	V/HKUR 10 E							5.80
End cap	EK/HKUR 10 E							5.29

Length = 2.5 m - 8' 2-1/2"	Brushed stainless steel 304 (1.4301 = V2A) (EB)		Brushed stainless steel 316L (1.4404 = V4A) (EBV4A)					
	Profile	\$ / Length	Outside corner 90°	Inside corner 90°	\$ / Unit	Outside corner 135°	Inside corner 135°	\$ / Unit
R = mm - in.								
10 - 3/8	HKUR 10 EB	61.50	EQ/HKUR 10 EB	I/HKU 3 R 10 EB	6.39	E135/HKUR 10 EB	I135/HKUR 10 EB	6.10
Connector	V/HKUR 10 EB							5.80
End cap	EK/HKUR 10 EB							5.29

Schluter®-DILEX-HKU (36 mm - 1-7/16" radius)

Length = 2.5 m - 8' 2-1/2"	Stainless steel 304 (1.4301 = V2A) (E)				
	Profile	\$ / Length	Outside corner 90°	Inside corner 90°*	\$ / Unit
R = mm - in.					
36 - 1-7/16	HKUR 36 E	92.00	E/HKUR 36 E	I/HKU 3 R 36 10 E	11.17
External connector, stainless steel	V/HKUR 36 E				11.17
Internal connector, EPS foam	V/HKUR 36				3.16
End cap	EK/HKUR 36 E (grey PVC only)				8.41

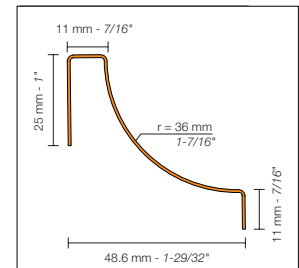

*For 3-way inside corners, use the Schluter®-DILEX-EHK profile on the vertical (page 90).

Internal connector, EPS foam





Schluter®-VINPRO

Profiles designed for resilient surface coverings (LVT)

Luxury vinyl and other resilient flooring materials have improved and evolved into a whole new generation of vinyl floor coverings. Mimicking the natural looks of wood and stone using high-fidelity printing, the product is durable and realistic in both finish and texture. Following trends or creating custom layouts, resilient coverings are not limited to floors and can offer a fresh design and additional warmth to walls in a residential or commercial environment.

VINPRO is a series of finishing, edge-protection and transition profiles designed for luxury vinyl and other resilient coverings, for floors, walls, and stair surfaces.



Schluter®-VINPRO-STEP-R in brushed antique bronze (page 97)



Schluter®-VINPRO-S

Schluter®-VINPRO-S is designed to provide edging for resilient coverings (e.g., LVT). Typical applications include edge protection where the resilient covering is bordered by carpet, floor coverings of similar heights, or as a finishing edge to wall skirting applications. The profile features a 1/4" (6 mm) or 7/16" (11 mm) wide sloped top flange to hide the cut edge of the resilient floor covering, providing a finished look.

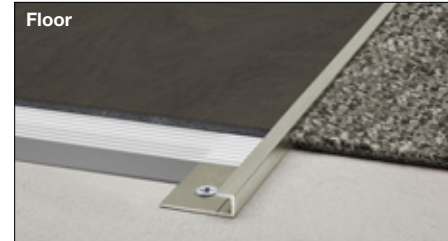
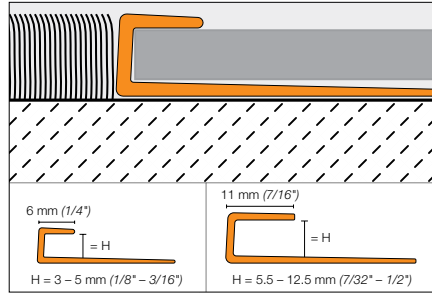

Schluter®-VINPRO-S							
Length = 2.5 m - 8' 2-1/2"	Brushed chrome anod. alu. (ACGB)		Brushed nickel anod. alu. (ATGB)		Brushed antique bronze anod. alu. (ABGB)		
H = mm - in.	Item No.	\$ / Length	Item No.	\$ / Length	Item No.	\$ / Length	
3 - 1/8	VPS 30 ACGB	16.57	VPS 30 ATGB	17.70	VPS 30 ABGB	18.52	
4 - 5/32	VPS 40 ACGB	16.77	VPS 40 ATGB	17.91	VPS 40 ABGB	18.79	
5 - 3/16	VPS 50 ACGB	16.93	VPS 50 ATGB	18.08	VPS 50 ABGB	18.93	
5.5 - 7/32	VPSL 55 ACGB	21.60	VPSL 55 ATGB	22.65	VPSL 55 ABGB	23.45	
6 - 1/4	VPSL 60 ACGB	21.82	VPSL 60 ATGB	22.89	VPSL 60 ABGB	23.68	
6.5 - 17/64	VPSL 65 ACGB	22.04	VPSL 65 ATGB	23.11	VPSL 65 ABGB	23.92	
7 - 9/32	VPSL 70 ACGB	22.26	VPSL 70 ATGB	23.35	VPSL 70 ABGB	24.16	
7.5 - 19/64	VPSL 75 ACGB	22.48	VPSL 75 ATGB	23.58	VPSL 75 ABGB	24.41	
8 - 5/16	VPSL 80 ACGB	22.69	VPSL 80 ATGB	23.82	VPSL 80 ABGB	24.64	
8.5 - 21/64	VPSL 85 ACGB	22.93	VPSL 85 ATGB	24.05	VPSL 85 ABGB	24.90	
9 - 11/32	VPSL 90 ACGB	23.15	VPSL 90 ATGB	24.28	VPSL 90 ABGB	25.14	
10 - 3/8	VPSL 100 ACGB	23.39	VPSL 100 ATGB	24.54	VPSL 100 ABGB	25.40	
11 - 7/16	VPSL 110 ACGB	23.63	VPSL 110 ATGB	24.77	VPSL 110 ABGB	25.65	
12.5 - 1/2	VPSL 125 ACGB	23.86	VPSL 125 ATGB	25.03	VPSL 125 ABGB	25.91	

Schluter®-VINPRO-T

Schluter®-VINPRO-T is designed to provide transitions between same-height resilient floor coverings, (e.g., LVT) primarily in retrofit applications.

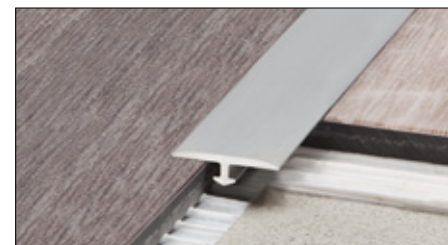
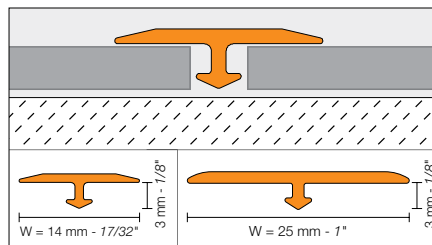

Schluter®-VINPRO-T							
Length = 2.5 m - 8' 2-1/2"	Brushed chrome anod. alu. (ACGB)		Brushed nickel anod. alu. (ATGB)		Brushed antique bronze anod. alu. (ABGB)		
W = mm - in.	Item No.	\$ / Length	Item No.	\$ / Length	Item No.	\$ / Length	
14 - 17/32	VPT 3/14 ACGB	13.96	VPT 3/14 ATGB	13.96	VPT 3/14 ABGB	13.96	
25 - 1	VPTL 3/25 ACGB	17.77	VPTL 3/25 ATGB	17.77	VPTL 3/25 ABGB	17.77	



Schluter®-VINPRO-U

Schluter®-VINPRO-U is designed to provide a smooth transition between resilient floor coverings (e.g. LVT) and floor coverings at lower elevations or finished concrete. The profile features a 1/4" (6 mm) or 7/16" (11 mm) wide sloped top flange to hide the cut edge of the resilient floor covering, providing a finished look.

ADA-Compliant

In installations where the leading edge abuts a lower surface covering, all sizes of VINPRO-U are compliant with the Americans with Disabilities Act (ADA). In installations where the leading edge rests on top of the lower floor covering (e.g., finished concrete), the 7/16" (11 mm) and 1/2" (12.5 mm) sizes are not ADA-compliant.

Technical Note: ADA requirements regarding transitions between surfaces of different heights:

- Up to 6 mm (1/4") - no special requirements
- 6 mm (1/4") to 12.5 mm (1/2") - slope ratio, 1:2
- More than 12.5 mm (1/2") - slope ratio, 1:12

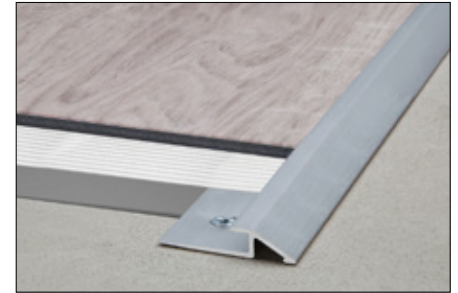
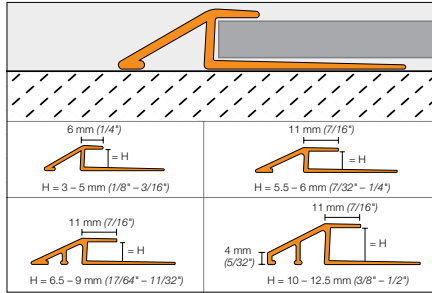
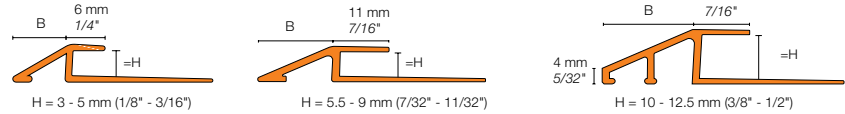

Diagram Values



H = mm - in		B = mm - in	
3	- 1/8	8	- 5/16
4	- 5/32	9.5	- 3/8
5	- 3/16	11.5	- 29/64
5.5	- 7/32	15.4	- 19/32
6	- 1/4	16.5	- 21/32
6.5	- 17/64	17.5	- 11/16
7	- 9/32	18.6	- 47/64
7.5	- 19/64	19.7	- 25/32
8	- 5/16	20.8	- 13/16
8.5	- 21/64	21.8	- 55/64
9	- 11/32	22.9	- 29/32
10	- 3/8	19.2	- 49/64
11	- 7/16	21.5	- 27/32
12.5	- 1/2	24.7	- 31/32

Schluter®-VINPRO-U

Length = 2.5 m - 8' 2-1/2"	Brushed chrome anod. alu. (ACGB)		Brushed nickel anod. alu. (ATGB)		Brushed antique bronze anod. alu. (ABGB)	
	Item No.	\$ / Length	Item No.	\$ / Length	Item No.	\$ / Length
H = 3 - 1/8	VPU 30 ACGB	19.07	VPU 30 ATGB	20.36	VPU 30 ABGB	21.29
4 - 5/32	VPU 40 ACGB	19.42	VPU 40 ATGB	20.71	VPU 40 ABGB	21.75
5 - 3/16	VPU 50 ACGB	20.13	VPU 50 ATGB	21.40	VPU 50 ABGB	22.45
5.5 - 7/32	VPUL 55 ACGB	31.05	VPUL 55 ATGB	33.35	VPUL 55 ABGB	34.16
6 - 1/4	VPUL 60 ACGB	31.98	VPUL 60 ATGB	34.36	VPUL 60 ABGB	35.19
6.5 - 17/64	VPUL 65 ACGB	32.94	VPUL 65 ATGB	35.38	VPUL 65 ABGB	36.24
7 - 9/32	VPUL 70 ACGB	33.93	VPUL 70 ATGB	36.45	VPUL 70 ABGB	37.33
7.5 - 19/64	VPUL 75 ACGB	34.95	VPUL 75 ATGB	37.54	VPUL 75 ABGB	38.46
8 - 5/16	VPUL 80 ACGB	36.00	VPUL 80 ATGB	38.66	VPUL 80 ABGB	39.62
8.5 - 21/64	VPUL 85 ACGB	37.07	VPUL 85 ATGB	39.82	VPUL 85 ABGB	40.80
9 - 11/32	VPUL 90 ACGB	38.19	VPUL 90 ATGB	41.01	VPUL 90 ABGB	42.01
10 - 3/8	VPUL 100 ACGB	41.64	VPUL 100 ATGB	47.68	VPUL 100 ABGB	52.41
11 - 7/16	VPUL 110 ACGB	42.88	VPUL 110 ATGB	49.12	VPUL 110 ABGB	53.98
12.5 - 1/2	VPUL 125 ACGB	44.18	VPUL 125 ATGB	50.59	VPUL 125 ABGB	55.60



Schluter®-VINPRO-RO

Schluter®-VINPRO-RO is a finishing and edging profile for resilient covering (e.g., LVT) installations on stairs and outside corners of resilient surfaces. The reveal of the profile forms a symmetrically rounded corner along the surface edge.

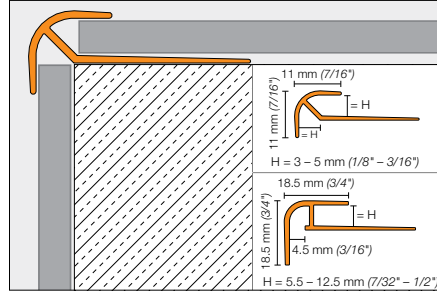

Schluter®-VINPRO-RO						
Length = 2.5 m - 8' 2-1/2"	Brushed chrome anod. alu. (ACGB)		Brushed nickel anod. alu. (ATGB)		Brushed antique bronze anod. alu. (ABGB)	
H = mm - in.	Item No.	\$/ Length	Item No.	\$/ Length	Item No.	\$/ Length
3 - 1/8	VPRO 30 ACGB	24.02	VPRO 30 ATGB	25.58	VPRO 30 ABGB	26.75
4 - 5/32	VPRO 40 ACGB	24.31	VPRO 40 ATGB	25.88	VPRO 40 ABGB	27.05
5 - 3/16	VPRO 50 ACGB	24.77	VPRO 50 ATGB	26.34	VPRO 50 ABGB	27.51
5.5 - 7/32	VPROL 55 ACGB	33.14	VPROL 55 ATGB	34.45	VPROL 55 ABGB	34.78
6 - 1/4	VPROL 60 ACGB	33.48	VPROL 60 ATGB	34.80	VPROL 60 ABGB	35.12
6.5 - 17/64	VPROL 65 ACGB	33.81	VPROL 65 ATGB	35.14	VPROL 65 ABGB	35.47
7 - 9/32	VPROL 70 ACGB	34.14	VPROL 70 ATGB	35.50	VPROL 70 ABGB	35.82
7.5 - 19/64	VPROL 75 ACGB	34.49	VPROL 75 ATGB	35.85	VPROL 75 ABGB	36.18
8 - 5/16	VPROL 80 ACGB	34.84	VPROL 80 ATGB	36.20	VPROL 80 ABGB	36.54
8.5 - 21/64	VPROL 85 ACGB	35.18	VPROL 85 ATGB	36.57	VPROL 85 ABGB	36.91
9 - 11/32	VPROL 90 ACGB	35.54	VPROL 90 ATGB	36.94	VPROL 90 ABGB	37.27
10 - 3/8	VPROL 100 ACGB	35.90	VPROL 100 ATGB	37.30	VPROL 100 ABGB	37.65
11 - 7/16	VPROL 110 ACGB	36.24	VPROL 110 ATGB	37.68	VPROL 110 ABGB	38.03
12.5 - 1/2	VPROL 125 ACGB	36.61	VPROL 125 ATGB	38.06	VPROL 125 ABGB	38.40



Schluter®-VINPRO-STEP

Schluter®-VINPRO-STEP is a finishing and edging profile for resilient floor covering (e.g. LVT) installations on stairs. Two versions are available: the 1/8"-3/16" (3-5 mm) version featuring a 1/4" (6 mm) wide top flange that is grooved to add slip resistance to the horizontal surface, and the 7/32" (5.5 mm) and larger versions that feature a 7/16" (11 mm) wide top flange with a smooth horizontal surface finish. The vertical leg covers the edge of the subassembly and top of the riser.

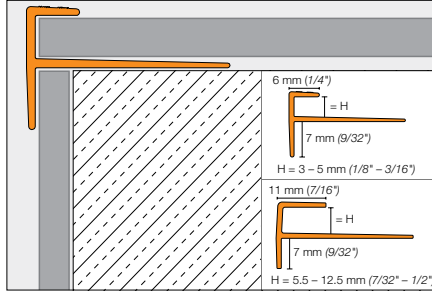

Schluter®-VINPRO-STEP							
Length = 2.5 m - 8' 2-1/2"		Brushed chrome anod. alu. (ACGB)		Brushed nickel anod. alu. (ATGB)		Brushed antique bronze anod. alu. (ABGB)	
H = mm - in.	Item No.	\$/ Length	Item No.	\$/ Length	Item No.	\$/ Length	
3 - 1/8	VPST 30 ACGB	23.38	VPST 30 ATGB	25.01	VPST 30 ABGB	25.01	
4 - 5/32	VPST 40 ACGB	23.55	VPST 40 ATGB	25.24	VPST 40 ABGB	25.24	
5 - 3/16	VPST 50 ACGB	23.77	VPST 50 ATGB	25.47	VPST 50 ABGB	25.47	
5.5 - 7/32	VPSTL 55 ACGB	26.81	VPSTL 55 ATGB	28.33	VPSTL 55 ABGB	30.42	
6 - 1/4	VPSTL 60 ACGB	27.62	VPSTL 60 ATGB	29.18	VPSTL 60 ABGB	31.33	
6.5 - 17/64	VPSTL 65 ACGB	28.44	VPSTL 65 ATGB	30.06	VPSTL 65 ABGB	32.28	
7 - 9/32	VPSTL 70 ACGB	29.30	VPSTL 70 ATGB	30.96	VPSTL 70 ABGB	33.25	
7.5 - 19/64	VPSTL 75 ACGB	30.19	VPSTL 75 ATGB	31.89	VPSTL 75 ABGB	34.25	
8 - 5/16	VPSTL 80 ACGB	31.09	VPSTL 80 ATGB	32.85	VPSTL 80 ABGB	35.26	
8.5 - 21/64	VPSTL 85 ACGB	32.02	VPSTL 85 ATGB	33.84	VPSTL 85 ABGB	36.34	
9 - 11/32	VPSTL 90 ACGB	32.98	VPSTL 90 ATGB	34.85	VPSTL 90 ABGB	37.42	
10 - 3/8	VPSTL 100 ACGB	33.97	VPSTL 100 ATGB	35.90	VPSTL 100 ABGB	38.54	
11 - 7/16	VPSTL 110 ACGB	34.99	VPSTL 110 ATGB	36.97	VPSTL 110 ABGB	39.70	
12.5 - 1/2	VPSTL 125 ACGB	36.04	VPSTL 125 ATGB	38.08	VPSTL 125 ABGB	40.89	

Schluter®-VINPRO-STEP-R

Schluter®-VINPRO-STEP-R is a finishing and edging profile for resilient covering (e.g., LVT) installations on stairs. The top of the profile features a capping flange with a rounded leading edge, while the elongated vertical section provides increased visibility.

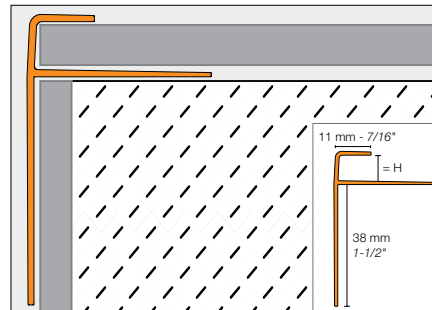

Schluter®-VINPRO-STEP-R							
Length = 2.5 m - 8' 2-1/2"		Brushed chrome anod. alu. (ACGB)		Brushed nickel anod. alu. (ATGB)		Brushed antique bronze anod. alu. (ABGB)	
H = mm - in.	Item No.	\$/ Length	Item No.	\$/ Length	Item No.	\$/ Length	
3 - 1/8	VPSTRL 30 ACGB	43.56	VPSTRL 30 ATGB	47.23	VPSTRL 30 ABGB	47.29	
4 - 5/32	VPSTRL 40 ACGB	44.00	VPSTRL 40 ATGB	47.70	VPSTRL 40 ABGB	47.77	
5 - 3/16	VPSTRL 50 ACGB	44.44	VPSTRL 50 ATGB	48.19	VPSTRL 50 ABGB	48.25	
5.5 - 7/32	VPSTRL 55 ACGB	44.88	VPSTRL 55 ATGB	48.67	VPSTRL 55 ABGB	48.73	
6 - 1/4	VPSTRL 60 ACGB	45.34	VPSTRL 60 ATGB	49.15	VPSTRL 60 ABGB	49.22	
6.5 - 17/64	VPSTRL 65 ACGB	45.80	VPSTRL 65 ATGB	49.64	VPSTRL 65 ABGB	49.71	
7 - 9/32	VPSTRL 70 ACGB	46.24	VPSTRL 70 ATGB	50.14	VPSTRL 70 ABGB	50.20	
7.5 - 19/64	VPSTRL 75 ACGB	46.71	VPSTRL 75 ATGB	50.65	VPSTRL 75 ABGB	50.71	
8 - 5/16	VPSTRL 80 ACGB	47.17	VPSTRL 80 ATGB	51.15	VPSTRL 80 ABGB	51.22	
8.5 - 21/64	VPSTRL 85 ACGB	47.64	VPSTRL 85 ATGB	51.66	VPSTRL 85 ABGB	51.73	
9 - 11/32	VPSTRL 90 ACGB	48.12	VPSTRL 90 ATGB	52.18	VPSTRL 90 ABGB	52.24	
10 - 3/8	VPSTRL 100 ACGB	48.61	VPSTRL 100 ATGB	52.71	VPSTRL 100 ABGB	52.77	
11 - 7/16	VPSTRL 110 ACGB	49.09	VPSTRL 110 ATGB	53.23	VPSTRL 110 ABGB	53.30	
12.5 - 1/2	VPSTRL 125 ACGB	49.58	VPSTRL 125 ATGB	53.76	VPSTRL 125 ABGB	53.83	



Schluter®-KERDI-BOARD

Waterproof, tile-ready substrates & building panels

Whether you work with mosaics or large-format tiles, an absolutely flat substrate with straight and precisely aligned inside and outside corners is essential for creating a perfect tile covering, which tile installers can now achieve on their own using KERDI-BOARD.

KERDI-BOARD gives tile setters control over their projects by providing them with the means to simply and easily create ideal substrates for tile. Unsuitable substrates can be remedied and new substrates can be produced while keeping the technical and aesthetic requirements of the tile covering in mind.

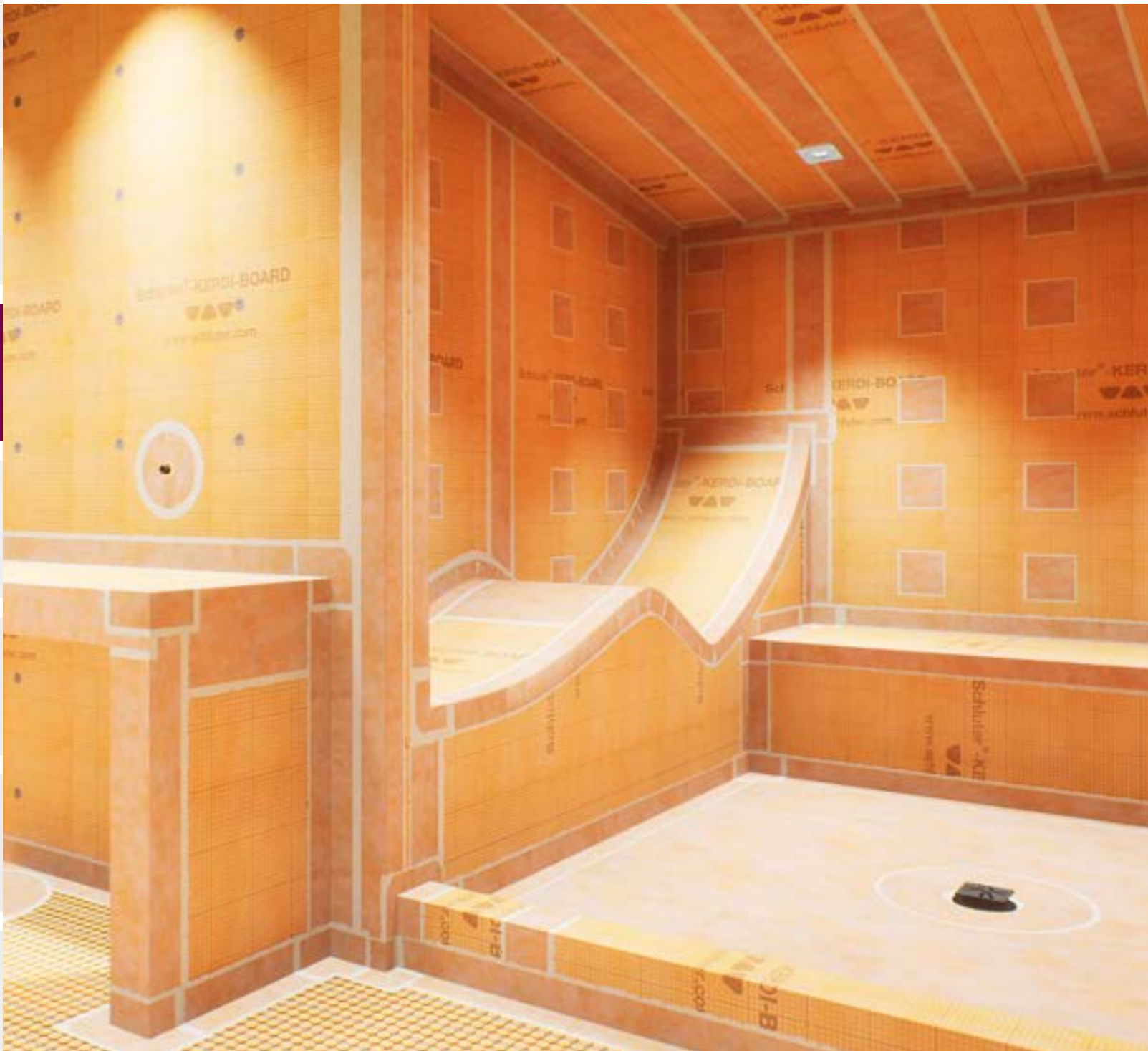



Schluter®-KERDI-BOARD

Schluter®-KERDI-BOARD is a multifunctional tile substrate and building panel, which can also be used for creating bonded waterproofing assemblies with tile coverings. It consists of an extruded polystyrene foam panel, with a special reinforcement material on both sides and fleece webbing for effective anchoring in thin-set mortar.

With the available panel thicknesses of 3/16", 3/8", 1/2", 5/8", 3/4", 1", 1-1/2", and 2" (5, 9, 12.5, 15, 19, 25, 38, and 50 mm), KERDI-BOARD allows the installer to prepare and create a broad range of substrates and building elements for the installation of ceramic and natural stone tile that are flat, level, plumb, square, and dimensionally stable. With suitable preparation of the abutting seams and joint areas, the panel may be used for bonded waterproofing assemblies.

The boards are simply cut to size with a utility knife. The gridlines, which are printed on the surface, are helpful for neat and quick cuts and installation. Tiles can be installed directly over KERDI-BOARD using the thin-set method.

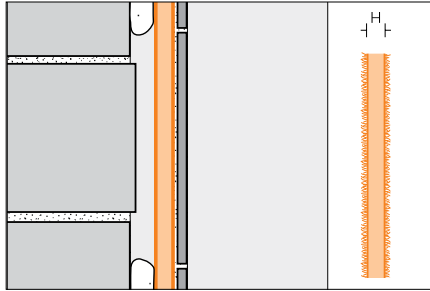

KERDI-BOARD By Pallet

The KERDI-BOARD panels listed in the table below are shipped in full pallets only. Please order in multiples of the pallet quantity.

Schluter®-KERDI-BOARD				
Substrate and building panel				
H = mm - in.	Item No.	\$ / Panel	Panels / Pallet	\$ / Pallet
Panel dimension: 122 cm x 81 cm – 48" x 32"				
12.5 - 1/2	KB 12 1220 812	44.18	144	6,361.92
Panel dimension: 122 cm x 162.5 cm – 48" x 64"				
12.5 - 1/2	KB 12 1220 1625	88.38	78	6,893.64
Panel dimension: 122 cm x 244 cm – 48" x 96"				
12.5 - 1/2	KB 12 1220 2440	132.54	75	9,940.50
15 - 5/8	KB 15 1220 2440	149.86	60	8,991.60
Panel dimension: 122 cm x 305 cm – 48" x 120"				
15 - 5/8	KB 15 1220 3050*	187.31	60	11,238.60

* KERDI-BOARD 5/8" panels in 48" x 120" format are available by special order only. Please contact Customer Service for more information.

KERDI-BOARD By Bundle

The KERDI-BOARD panels listed in the table below are shipped in bundles only. Please order in multiples of the bundle quantity.

Schluter®-KERDI-BOARD				
Substrate and building panel				
H = mm - in.	Item No.	\$ / Panel	Panels / Bundle	\$ / Bundle
Panel dimension: 122 cm x 162.5 cm – 48" x 64"				
5 - 3/16	KB 5 1220 1625	80.50	10	805.00
9 - 3/8	KB 9 1220 1625	84.44	8	675.52
Panel dimension: 122 cm x 244 cm – 48" x 96"				
5 - 3/16	KB 5 1220 2440	120.70	6	724.20
9 - 3/8	KB 9 1220 2440	126.63	5	633.15
Panel dimension: 62.5 cm x 244 cm – 24-1/2" x 96"				
19 - 3/4	KB 19 625 2440	72.47	6	434.82
25 - 1	KB 25 625 2440	76.97	4	307.88
38 - 1-1/2	KB 38 625 2440	88.19	3	264.57
50 - 2	KB 50 625 2440	99.07	3	297.21

⚠ WARNING: Cancer and Reproductive Harm - www.P65Warnings.ca.gov

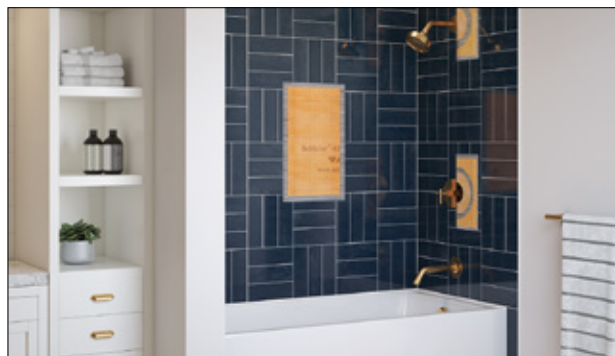

Schluter®-KERDI-BOARD-KIT

Complete kit for waterproofing walls around bathtubs and acrylic shower bases. Refer to page 164.





Schluter®-KERDI-BOARD-V

Schluter®-KERDI-BOARD-V is a vertically grooved substrate and building panel for creating curved elements. If a larger expanse of panels is required, several panels can be connected along the edges with thin-set mortar, Schluter®-KERDI-FIX adhesive, or double-sided adhesive tape.

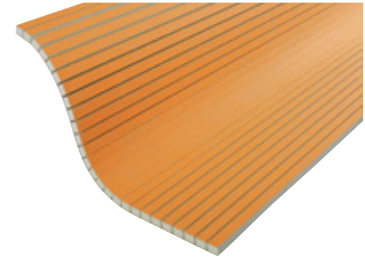
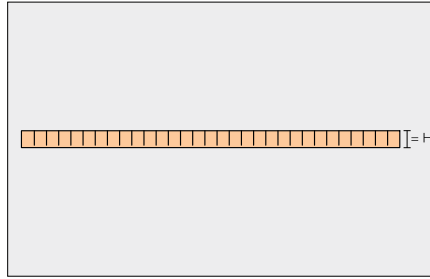

WARNING: Cancer and Reproductive Harm - www.P65Warnings.ca.gov

Schluter®-KERDI-BOARD-V				
Grooved substrate and building panel				
H = mm - in.	Item No.	\$ / Panel	Panels / Bundle	\$ / Bundle
Panel dimension: 62.5 cm x 244 cm – 24-1/2" x 96"				
19 - 3/4	KB 19 625 2440 V	88.07	6	528.42
25 - 1	KB 25 625 2440 V	95.92	4	383.68
38 - 1-1/2	KB 38 625 2440 V	105.61	3	316.83
50 - 2	KB 50 625 2440 V	116.47	3	349.41

Schluter®-KERDI-BOARD-E

Schluter®-KERDI-BOARD-E is an L-shaped panel used to create corners and pipe or column coverings.

The panels feature a V-shaped groove and are shipped in a space-saving flat design, which makes them easy to store. The flat panels are also quick to cut to the necessary dimensions. Thin-set mortar, Schluter®-KERDI-FIX adhesive, or double-sided adhesive tape is applied to the V-groove. The panels are then folded prior to installation.

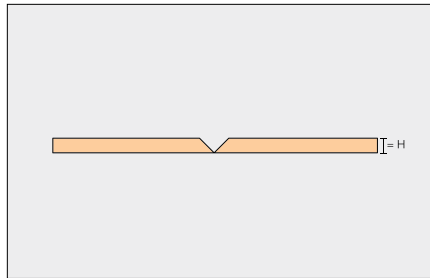

WARNING: Cancer and Reproductive Harm - www.P65Warnings.ca.gov

Schluter®-KERDI-BOARD-E				
L-shaped panel				
H = mm - in.	Item No.	\$ / Panel	Panels / Bundle	\$ / Bundle
Panel dimension: 62.5 cm x 244 cm – 24-1/2" x 96"				
19 - 3/4	KB 19 625 2440 E	95.00	6	570.00
25 - 1	KB 25 625 2440 E	100.86	4	403.44

Schluter®-KERDI-BOARD-U

Schluter®-KERDI-BOARD-U is a U-shaped panel used to create pipe or column coverings.

The panels feature V-shaped grooves and are shipped in a space-saving flat design, which makes them easy to store. The flat panels are also quick to cut to the necessary dimensions. Thin-set mortar, Schluter®-KERDI-FIX adhesive, or double-sided adhesive tape is applied to the V-grooves. The panels are then folded prior to installation.

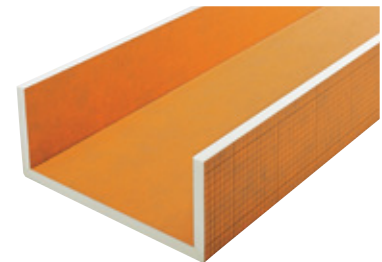
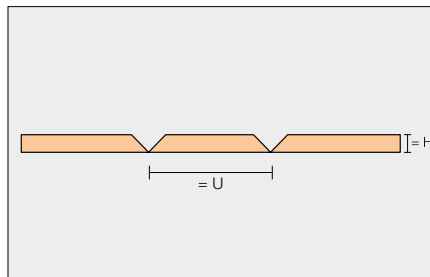

WARNING: Cancer and Reproductive Harm - www.P65Warnings.ca.gov

Schluter®-KERDI-BOARD-U				
U-shaped panel				
H = mm - in.	Item No.	\$ / Panel	Panels / Bundle	\$ / Bundle
Panel dimension: 62.5 cm x 244 cm – 24-1/2" x 96"				
U = 20 cm – 7-7/8"				
19 - 3/4	KB 19 625 2440 U 20	119.25	6	715.50
U = 30 cm – 11-13/16"				
19 - 3/4	KB 19 625 2440 U 30	119.25	6	715.50



Schluter®-KERDI-BOARD-SC

Schluter®-KERDI-BOARD-SC is a prefabricated shower curb made of KERDI-BOARD that is designed to integrate with the Schluter®-Shower System. The curb is lightweight, stable, and load bearing. It can be used in conjunction with the KERDI-SHOWER prefabricated shower trays as well as in mortar bed applications. KERDI-BOARD-SC is quick and easy to install, waterproof and ready to tile, making it a simple solution for tiled shower curbs.

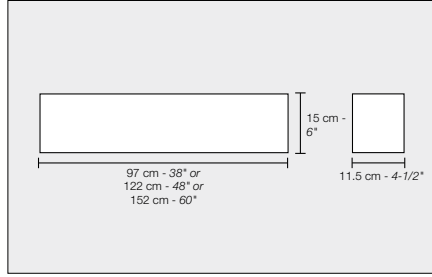

Schluter®-KERDI-BOARD-SC				
Curb				
Item No.	Length	Width	Height	\$ / Unit
KBSC 115 150 970	97 cm - 38"	11.5 cm - 4-1/2"	15 cm - 6"	65.85
KBSC 115 150 1220	122 cm - 48"	11.5 cm - 4-1/2"	15 cm - 6"	71.83
KBSC 115 150 1524	152 cm - 60"	11.5 cm - 4-1/2"	15 cm - 6"	105.35

⚠ WARNING: Cancer and Reproductive Harm - www.P65Warnings.ca.gov

Schluter®-KERDI-BOARD-SB

Schluter®-KERDI-BOARD-SB is a prefabricated shower bench made of KERDI-BOARD that is designed to integrate with the Schluter®-Shower System. The bench is lightweight, stable, and load bearing. It features a sloped surface to prevent the accumulation of water. KERDI-BOARD-SB is quick and easy to install, waterproof and ready to tile, making it a simple solution for tiled shower benches.

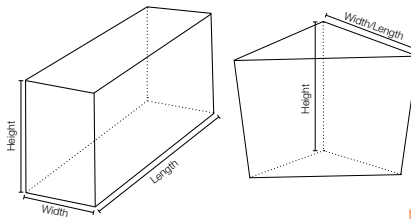

Includes 2 inside and 2 outside KERDI-KERECK waterproofing corners.

Schluter®-KERDI-BOARD-SB					
Bench					
Item No.	Length	Width	Height	Shape	\$ / Unit
KBSB 410 TA	41 cm - 16"	41 cm - 16"	51 cm - 20"	Triangular	181.97
KBSB 610 TA	61 cm - 24"	61 cm - 24"	51 cm - 20"	Triangular	237.05
KBSB 290 970 RA	97 cm - 38"	29 cm - 11-1/2"	51 cm - 20"	Rectangular	293.32
KBSB 410 1220 RA	122 cm - 48"	41 cm - 16"	51 cm - 20"	Rectangular	389.10

⚠ WARNING: Cancer and Reproductive Harm - www.P65Warnings.ca.gov



Schluter®-KERDI-BOARD-SN

Schluter®-KERDI-BOARD-SN is a prefabricated shower niche made of Schluter®-KERDI-BOARD that can be installed in both Schluter®-KERDI and KERDI-BOARD wall assemblies. The shower niche features a 1/2" (12.5 mm) -thick by 2" (50 mm) -wide integrated bonding flange and is available in 4 different sizes.

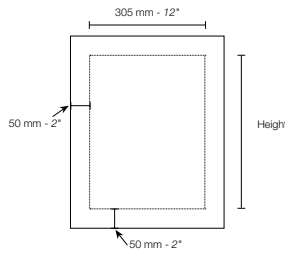

Schluter®-KERDI-BOARD-SN					
Niche					
Item No.	Height	Width	Depth	Shelf	\$/ Unit
KB 12 SN 305 152 A	152 mm - 6"	305 mm - 12"	89 mm - 3-1/2"	-	65.26
KB 12 SN 305 305 A	305 mm - 12"	305 mm - 12"	89 mm - 3-1/2"	-	78.16
KB 12 SN 305 508 A1	508 mm - 20"	305 mm - 12"	89 mm - 3-1/2"	1	105.65
KB 12 SN 305 711 A1	711 mm - 28"	305 mm - 12"	89 mm - 3-1/2"	1	126.27

⚠ WARNING: Cancer and Reproductive Harm - www.P65Warnings.ca.gov

See your Shower
in a Whole New

Light



NEW!
Schluter®-KERDI-BOARD-SNLT
Shower niches with integrated
LIPROTEC LED lighting (page 158)



Schluter®-KERDI-BOARD-ZC

Schluter®-KERDI-BOARD-ZC is a brushed stainless steel, U-shaped profile with one perforated anchoring leg. It is used to finish the edges of countertops, vanities, and similar structures in conjunction with the Schluter®-RONDEC or Schluter®-QUADEC finishing profiles.

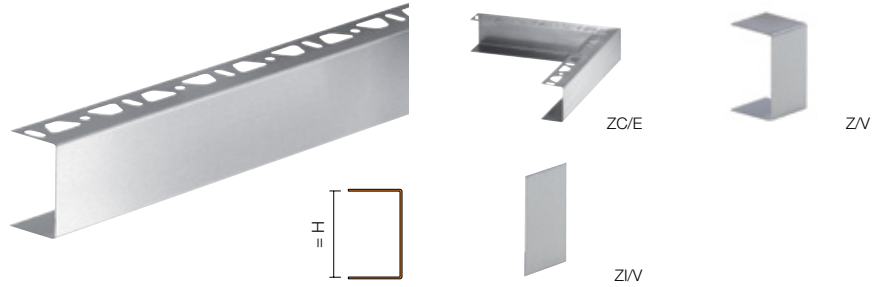

Schluter®-KERDI-BOARD-ZC		
U-shaped brushed stainless steel profile with 1 perforated anchoring leg		
H = mm - in.	Item No.	\$ / Length
Length = 2.50 m - 8' 2-1/2"		
38 - 1-1/2	KB ZC 38 EB	67.88
50 - 2	KB ZC 50 EB	74.17

Schluter®-KERDI-BOARD-ZC/E		
Brushed stainless steel outside corner piece for ZC		
H = mm - in.	Item No.	\$ / Unit
38 - 1-1/2	E/KB ZC 38 EB	24.47
50 - 2	E/KB ZC 50 EB	24.47

Schluter®-KERDI-BOARD-Z/V		
Brushed stainless steel connector for ZC and ZA		
H = mm - in.	Item No.	\$ / Unit
38 - 1-1/2	V/KB Z 38 EB	7.71
50 - 2	V/KB Z 50 EB	7.71

Schluter®-KERDI-BOARD-ZI/V		
Stainless steel internal connector for ZC and ZA		
H = mm - in.	Item No.	\$ / Unit
38 - 1-1/2	V/KB ZI 38 E	4.78
50 - 2	V/KB ZI 50 E	4.78

Schluter®-KERDI-BOARD-ZA

Schluter®-KERDI-BOARD-ZA is a brushed stainless steel, U-shaped profile with two perforated anchoring legs. It is used to finish visible edges of partition walls and shelves.

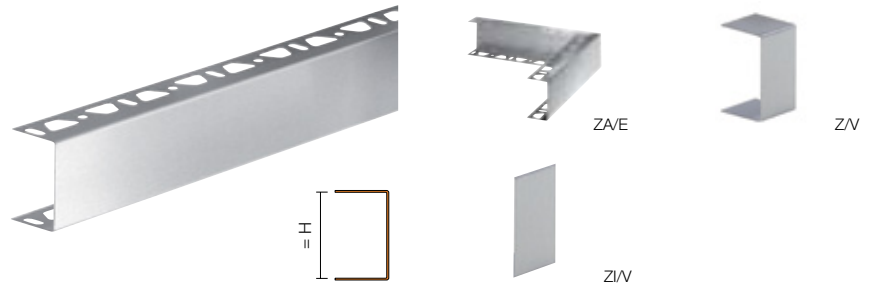

Schluter®-KERDI-BOARD-ZA		
U-shaped brushed stainless steel profile with 2 perforated anchoring legs		
H = mm - in.	Item No.	\$ / Length
Length = 2.50 m - 8' 2-1/2"		
19 - 3/4	KB ZA 19 EB	57.63
25 - 1	KB ZA 25 EB	62.23
38 - 1-1/2	KB ZA 38 EB	67.88
50 - 2	KB ZA 50 EB	74.17

Schluter®-KERDI-BOARD-ZA/E		
Brushed stainless steel outside corner piece for ZA		
H = mm - in.	Item No.	\$ / Unit
38 - 1-1/2	E/KB ZA 38 EB	24.47
50 - 2	E/KB ZA 50 EB	24.47

Schluter®-KERDI-BOARD-Z/V		
Brushed stainless steel connector for ZC and ZA		
H = mm - in.	Item No.	\$ / Unit
19 - 3/4	V/KB Z 19 EB	7.71
25 - 1	V/KB Z 25 EB	7.71
38 - 1-1/2	V/KB Z 38 EB	7.71
50 - 2	V/KB Z 50 EB	7.71

Schluter®-KERDI-BOARD-ZI/V		
Stainless steel internal connector for ZC and ZA		
H = mm - in.	Item No.	\$ / Unit
19 - 3/4	V/KB ZI 19 E	4.78
25 - 1	V/KB ZI 25 E	4.78
38 - 1-1/2	V/KB ZI 38 E	4.78
50 - 2	V/KB ZI 50 E	4.78



Schluter®-KERDI-BOARD-ZB

Schluter®-KERDI-BOARD-ZB is a stainless steel, U-shaped profile with three-sided perforation. It is used to fasten and stabilize partition walls and other structures made of KERDI-BOARD panels. The surfaces of the profile are hidden by the tile covering.

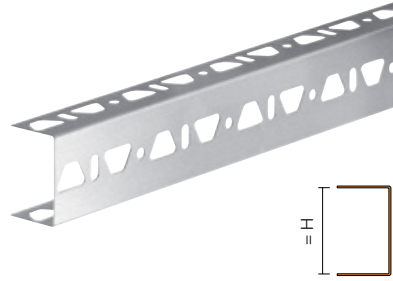

Schluter®-KERDI-BOARD-ZB		
U-shaped stainless steel profile with 3 perforated anchoring legs		
H = mm - in.	Item No.	\$ / Length
Length = 2.50 m - 8' 2-1/2"		
19 - 3/4	KB ZB 19 E	49.66
25 - 1	KB ZB 25 E	53.63
38 - 1-1/2	KB ZB 38 E	58.04
50 - 2	KB ZB 50 E	63.69

Schluter®-KERDI-BOARD-ZW

Schluter®-KERDI-BOARD-ZW is a stainless steel angle profile with two trapezoid perforated anchoring legs. It is used to fasten and stabilize structures made of KERDI-BOARD panels. It is attached to the substrate with either screws or thin-set mortar.

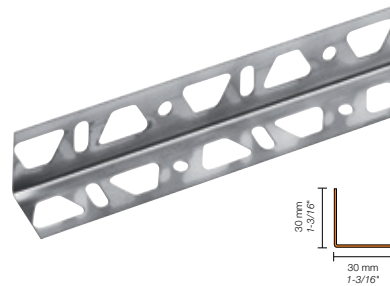

Schluter®-KERDI-BOARD-ZW	
Stainless steel angle profile	
Item No.	\$ / Length
Length = 15 cm - 6"	
KB ZW 30 E/15	1.93
Length = 2.50 m - 8' 2-1/2"	
KB ZW 30 E	28.71

Schluter®-KERDI-BOARD-ZSD

Schluter®-KERDI-BOARD-ZSD are anchors used to provide additional mechanical attachment of KERDI-BOARD when the bond between the thin-set mortar and the substrate is questionable.

Appropriate drill bit size: 8 mm - 5/16".
Drill hole 10 mm - 3/8" deeper than anchor length.

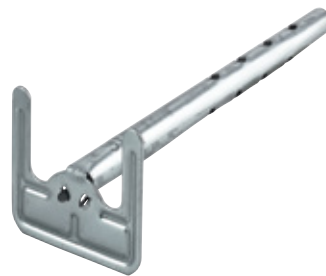

Schluter®-KERDI-BOARD-ZSD			
Stainless steel anchor			
Size = cm - in.	Item No.	Anchors / Box	\$ / Box
9 - 3-1/2	KB ZSD 90 E	25	33.11
11 - 4-5/16	KB ZSD 110 E	25	38.22
Galvanized steel anchor			
9 - 3-1/2	KB ZSD 90 Z	25	17.77
11 - 4-5/16	KB ZSD 110 Z	25	20.45



Schluter®-KERDI-BOARD-ZT/-ZS

Schluter®-KERDI-BOARD-ZT are galvanized steel washers used to fasten KERDI-BOARD to stud framing. They feature tabs that penetrate the surface of the KERDI-BOARD and temporarily hold the washers in place to enable quick installation of the corresponding screws.

Schluter®-KERDI-BOARD-ZS are screws used to fasten KERDI-BOARD to stud framing with the corresponding washers.

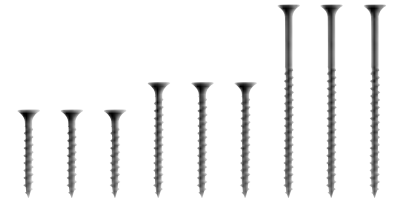
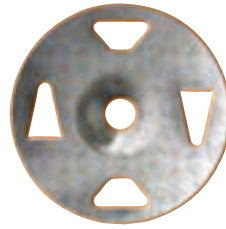

Schluter®-KERDI-BOARD-ZT			
Galvanized steel attachment washer			
Size = mm - in.	Item No.	Washers / Box	\$ / Box
32 - 1-1/4	KB ZT 32 Z	100	13.14
32 - 1-1/4	KB ZT 32 Z/L	1000	108.93

Schluter®-KERDI-BOARD-ZS			
Threaded screw for stud framing			
Size = mm - in.	Item No.	Screws / Box	\$ / Box
41 - 1-5/8	KB ZS 35 G	200	17.93
50 - 2	KB ZS 55 G	100	13.14
75 - 3	KB ZS 75 G	100	20.06



Convenient retail packaging.

Schluter®-KERDI-BOARD-ZT/-ZS			
Washer and Screw Set			
Size = mm - in.	Item No.	Pieces / Box	\$ / Box
41 - 1-5/8	KB ZS 35 GT 32 Z	40 each	14.94
41 - 1-5/8	KB ZS 35 GT 32 Z 100	100 each	28.20

Schluter®-KERDI-BOARD-ZFP

Schluter®-KERDI-BOARD-ZFP is a flat plastic profile, which is adhered behind the KERDI-BOARD-ZA U-shaped profile to improve fastening of hardware with screws.



Schluter®-KERDI-BOARD-ZFP		
Flat plastic profile		
Width mm - in.	Item No.	\$ / Length
Length = 2.50 m - 8' 2-1/2"		
35 - 1-3/8	KB ZFP 35	12.58



Schluter®-KERDI-BAND

Schluter®-KERDI-BAND is a waterproofing strip used to seal joints, corners, and fastener penetrations with the Schluter®-KERDI-BOARD building panels, as well as butt joints and floor/wall connections with the Schluter®-KERDI, DITRA, and DITRA-HEAT membranes.

Note: 1 mil = 1 one-thousandth of an inch

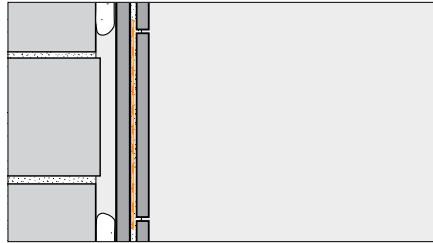

Schluter®-KERDI-BAND					
Waterproofing strip					
Item No.	Width	Length	Thickness	\$ / ft *	\$ / Roll
125 mm - 5" width					
KEBA 100/125/5M	125 mm - 5"	5 m - 16' 5"	4 mil	1.44	23.59
KEBA 100/125/10M	125 mm - 5"	10 m - 33'	4 mil	1.36	44.80
KEBA 100/125	125 mm - 5"	30 m - 98' 5"	4 mil	1.12	110.71
KEBA100/125/300	125 mm - 5"	300 m - 984' 3"	4 mil	1.01	996.46
185 mm - 7-1/4" width					
KEBA 100/185/5M	185 mm - 7-1/4"	5 m - 16' 5"	4 mil	1.88	30.89
KEBA 100/185	185 mm - 7-1/4"	30 m - 98' 5"	4 mil	1.56	153.05
250 mm - 10" width					
KEBA 100/250/5M	250 mm - 10"	5 m - 16' 5"	4 mil	2.35	38.50
KEBA 100/250	250 mm - 10"	30 m - 98' 5"	4 mil	2.00	196.79

* The price per foot is for estimation purposes only. Please order using the price per roll.

Schluter®-KERDI-BOARD-ZSA

Schluter®-KERDI-BOARD-ZSA is an adhesive tape for reinforcing the joint areas of KERDI-BOARD panels.



Schluter®-KERDI-BOARD-ZSA			
Joint reinforcement tape			
Item No.	Width	Length	\$ / Roll
KB ZSA 100/45 M	100 mm - 4"	45 m - 148'	19.53

Schluter®-KERDI-BOARD-ZDK

Schluter®-KERDI-BOARD-ZDK is a double-sided adhesive tape used to attach KERDI-BOARD panels in joint areas or similar.



Schluter®-KERDI-BOARD-ZDK			
Double-sided tape			
Item No.	Width	Length	\$ / Roll
KB ZDK 12/10 M	12.5 mm - 1/2"	10 m - 33'	10.99
KB ZDK 19/10 M	19 mm - 3/4"	10 m - 33'	17.02
KB ZDK 30/10 M	30 mm - 1-3/16"	10 m - 33'	26.73



Schluter®-Systems

Waterproofing & uncoupling membranes

Ceramic and stone tiles are durable, easy to maintain, and hygienic, representing the ideal surface coverings. However, today's lightweight construction methods can make the installation of hard surface coverings particularly challenging. Schluter Systems has developed state-of-the-art installation systems that address the problems associated with today's construction methods, allowing the installation of ceramic and stone tiles on virtually any surface.

DITRA provides uncoupling to prevent cracked tiles and grout, while providing effective waterproofing to protect moisture-sensitive substrates. KERDI is a pliable, sheet-applied waterproofing membrane and vapor-retarder ideal for use in tiled showers, bathtub surrounds, and other wet areas.



Schluter®-DITRA and Schluter®-DITRA-XL

Schluter®-DITRA and **Schluter®-DITRA-XL** are polyethylene uncoupling membranes with a grid structure of square cutback cavities and an anchoring fleece laminated to the underside. DITRA and DITRA-XL provide uncoupling through the open rib structure, which allows for in-plane movement that effectively neutralizes the differential movement stresses between the substrate and the tile, thus eliminating the major cause of cracking and delaminating of the tiled surface. In conjunction with tile coverings, DITRA and DITRA-XL form an uncoupling, waterproofing, and vapor management layer, while providing support/load distribution. The combination of these four essential functions allows for the successful installation of tile over a wide range of substrates, including plywood/OSB, concrete, gypsum, heated floors, etc.

DITRA is 1/8" (3.5 mm) thick, which minimizes tile assembly thickness and reduces transitions to lower surface coverings (e.g., carpet, engineered wood, and vinyl). DITRA allows for ceramic tile application over single-layer plywood or OSB subfloors on joists spaced up to 19.2" (488 mm) o.c. DITRA is listed by cUPC®.

DITRA-XL is 5/16" (7 mm) thick, which permits even transitions between tile and 3/4"-thick hardwood flooring. DITRA-XL allows for ceramic tile application over single-layer plywood/OSB subfloors on joists spaced up to 24" (610 mm) o.c.

DITRA and DITRA-XL were evaluated according to the "Standard Method for the Testing and Evaluation of Volatile Organic Chemical Emissions from Indoor Sources Using Environmental Chambers, Version 1.1 for California Specification 01350 and found to comply with the VOC requirements. California Specification 01350 is referenced by various green building standards and rating systems.

For complete information, a step-by-step installation video and the DITRA Installation Handbook are available for download at: **Schluter.com** or by contacting our Customer Service.

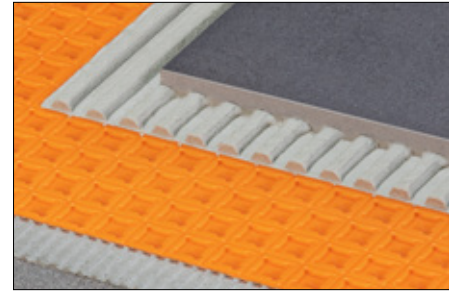
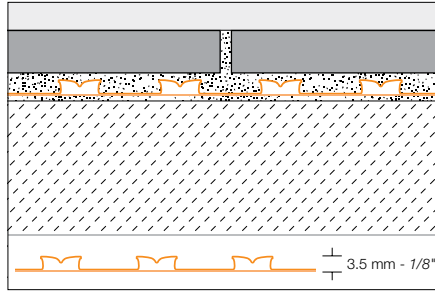

Schluter®-DITRA			
Uncoupling and waterproofing membrane 3.5 mm - 1/8"			
Item No.	Dimensions	\$ / ft² *	\$ / Roll
DITRA 5M	0.995 m x 5.1 m = 5 m² - 3' 3" x 16' 8" = 54 ft²	2.35	127.08
DITRA 150	0.995 m x 14.1 m = 14 m² - 3' 3" x 46' 3" = 150 ft²	2.18	327.29

* The price per square foot is for estimation purposes only. Please order using the price per roll.

DITRA By Pallet

DITRA 30M is shipped as full pallets only. Please order in multiples of the pallet quantity.

Schluter®-DITRA					
Uncoupling and waterproofing membrane 3.5 mm - 1/8"					
Item No.	Dimensions	\$ / ft² *	\$ / Roll	Rolls / Pallet	\$ / Pallet
DITRA 30M	0.995 m x 30.4 m = 30 m² 3' 3" x 99' 8" = 323 ft²	2.06	664.85	9	5,983.65

* The price per square foot is for estimation purposes only. Please order using the price per roll.

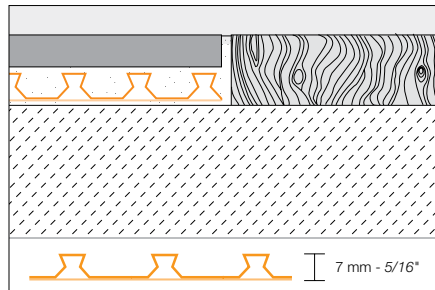

Schluter®-DITRA-XL			
Uncoupling and waterproofing membrane 7 mm - 5/16"			
Item No.	Dimensions	\$ / ft² *	\$ / Roll
DITRA-XL/175	1 m x 16.25 m = 16.25 m² - 3' 3" x 53' 3" = 175 ft²	2.41	421.81

* The price per square foot is for estimation purposes only. Please order using the price per roll.



Schluter®-SET, Schluter®-ALL-SET, and Schluter®-FAST-SET
See page 184



Schluter®-DITRA-TROWEL and Schluter®-DITRA-HEAT/-DITRA-XL-TROWEL
See page 187



Schluter®-DITRA THE ORIGINAL. NOW EVEN BETTER.

Easy Cut
Cutting grooves provide a guide for straight and precise cuts.

Easy Fill
Air release vents at the corners allow for faster filling of the membrane with fewer trowel passes.

Schluter®-KERDI-FLEX

Schluter®-KERDI-FLEX is a flexible polyethylene waterproofing strip used to seal movement joints over Schluter®-DITRA in specialty applications where large movements are expected, i.e. over expansion joints or construction joints.

Note: 1 mil = 1 one-thousandth of an inch

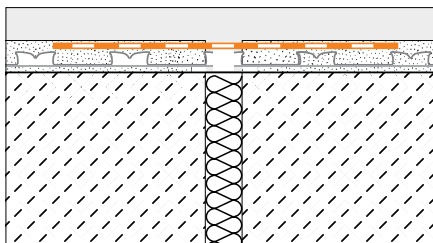

Schluter®-KERDI-FLEX					
Waterproofing strip for use above movement joints					
Item No.	Width	Length	Thickness	\$ / ft *	\$ / Roll
FLEX 125/5M	125 mm - 5"	5 m - 16' 5"	12 mil	2.72	44.58
FLEX 250/5M	250 mm - 10"	5 m - 16' 5"	12 mil	4.40	72.24
FLEX 125/30	125 mm - 5"	30 m - 98' 5"	12 mil	2.07	203.35
FLEX 250/30	250 mm - 10"	30 m - 98' 5"	12 mil	3.76	369.72

* The price per foot is for estimation purposes only. Please order using the price per roll.

Schluter®-KERDI and Schluter®-KERDI-DS

Schluter®-KERDI is a pliable sheet-applied polyethylene waterproofing membrane and vapor retarder that guarantees uniform thickness. It is covered with an anchoring fleece on both sides to anchor the membrane in thin-set mortar and is suitable for waterproofing in conjunction with tiled surfaces on walls and floors. KERDI is 8-mil thick and has a water vapor permeance of 0.90 perms, when tested according to ASTM E96, using Procedure E at 90% relative humidity.

Schluter®-KERDI-DS is a bonded waterproofing membrane and vapor retarder with very low water vapor permeance for use in continuous use steam rooms and similar applications. KERDI-DS is 20-mil thick and features additives to produce a water vapor permeance of 0.19 perms, when tested according to ASTM E96, using Procedure E at 90% relative humidity.

KERDI and KERDI-DS meet the American National Standard for Load Bearing, Bonded, Waterproof Membranes for Thin-Set Ceramic Tile and Dimension Stone Installations (ANSI A118.10). The membranes are listed by cUPC® and evaluated by ICC-ES (Report Nos. ESR-2467 and PMG-1204).

KERDI and KERDI-DS have been evaluated according to the "Standard Method for the Testing and Evaluation of Volatile Organic Chemical Emissions from Indoor Sources Using Environmental Chambers, Version 1.1" for California Specification 01350 and found to comply with the VOC requirements. California Specification 01350 is referenced by various green building standards and rating systems.

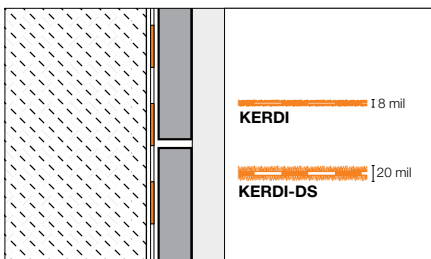

Note: 1 mil = 1 one-thousandth of an inch

Schluter®-KERDI			
Waterproofing membrane			
Item No.	Dimensions	\$ / ft ² *	\$ / Roll
Roll width: 1 m - 3' 3"			
KERDI 200/5M	1 m x 5 m = 5 m ² - 3' 3" x 16' 5" = 54 ft ²	2.35	127.08
KERDI 200/7M	1 m x 7 m = 7 m ² - 3' 3" x 23' = 75 ft ²	2.32	174.05
KERDI 200/10M	1 m x 10 m = 10 m ² - 3' 3" x 33' = 108 ft ²	2.28	246.75
KERDI 200/20M	1 m x 20 m = 20 m ² - 3' 3" x 65' 7" = 215 ft ²	2.19	471.57
KERDI 200	1 m x 30 m = 30 m ² - 3' 3" x 98' 5" = 323 ft ²	2.06	664.85
Roll width: 2 m - 6' 7"			
KERDI 200200/15M	2 m x 15 m = 30 m ² - 6' 7" x 49' 2-1/2" = 323 ft ²	2.06	664.85
KERDI 200200	2 m x 30 m = 60 m ² - 6' 7" x 98' 5" = 646 ft ²	1.97	1,273.83

Schluter®-KERDI-DS			
Waterproofing membrane			
Item No.	Dimensions	\$ / ft ² *	\$ / Roll
KERDI-DS	1 m x 30 m = 30 m ² - 3' 3" x 98' 5" = 323 ft ²	2.79	902.28

* The price per square foot is for estimation purposes only. Please order using the price per roll.



Schluter®-SET, Schluter®-ALL-SET, and Schluter®-FAST-SET
See page 184



Schluter®-KERDI-TROWEL
See page 187

The **WIDE** Roll

- ✓ Wide roll available in two lengths:
6' 7" x 49' 2-1/2" = **323 ft²** and 6' 7" x 98' 5" = **646 ft²**
- ✓ Fewer seams
- ✓ Faster installation
- ✓ Wide format covers wall area from floor to standard shower head height





Schluter®-KERDI-BAND

Schluter®-KERDI-BAND is a waterproofing strip used to seal butt joints and floor/wall connections with the Schluter®-KERDI, DITRA, and DITRA-HEAT membranes, as well as joints, corners, and fastener penetrations with the Schluter®-KERDI-BOARD building panels.

Note: 1 mil = 1 one-thousandth of an inch

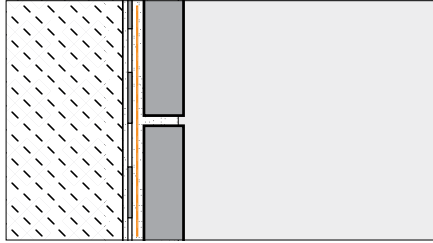

Schluter®-KERDI-BAND					
Waterproofing strip					
Item No.	Width	Length	Thickness	\$ / ft *	\$ / Roll
125 mm - 5" width					
KEBA 100/125/5M	125 mm - 5"	5 m - 16' 5"	4 mil	1.44	23.59
KEBA 100/125/10M	125 mm - 5"	10 m - 33'	4 mil	1.36	44.80
KEBA 100/125	125 mm - 5"	30 m - 98' 5"	4 mil	1.12	110.71
KEBA100/125/300	125 mm - 5"	300 m - 984' 3"	4 mil	1.01	996.46
185 mm - 7-1/4" width					
KEBA 100/185/5M	185 mm - 7-1/4"	5 m - 16' 5"	4 mil	1.88	30.89
KEBA 100/185	185 mm - 7-1/4"	30 m - 98' 5"	4 mil	1.56	153.05
250 mm - 10" width					
KEBA 100/250/5M	250 mm - 10"	5 m - 16' 5"	4 mil	2.35	38.50
KEBA 100/250	250 mm - 10"	30 m - 98' 5"	4 mil	2.00	196.79

* The price per foot is for estimation purposes only. Please order using the price per roll.

Schluter®-KERDI-KERECK-F

Schluter®-KERDI-KERECK-F are preformed, seamless corners made of Schluter®-KERDI for waterproofing inside and outside corners.

Note: 1 mil = 1 one-thousandth of an inch

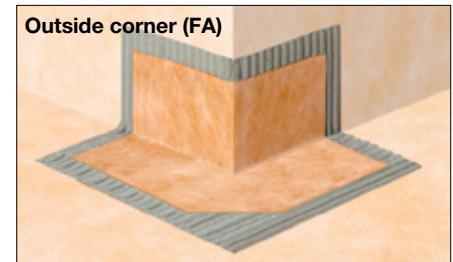
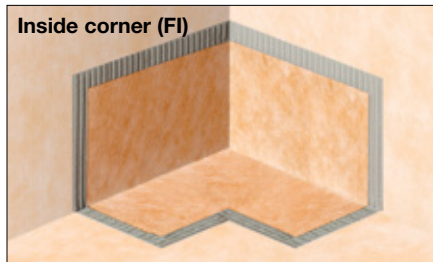

Schluter®-KERDI-KERECK-F			
Waterproofing for 90° corners			
Item No.	Thickness	Packaging	\$ / Package
KERECK/FI 2	4 mil	2 Inside corners	18.20
KERECK/FA 2	4 mil	2 Outside corners	18.20
Waterproofing for 135° corners			
KERECK 135 FI 2	4 mil	2 Inside corners	20.17

Schluter®-KERDI-KERECK-F			
Waterproofing for 90° corners			
Item No.	Thickness	Packaging	\$ / Package
KERECK/FI 10	4 mil	10 Inside corners	86.65
KERECK/FA 10	4 mil	10 Outside corners	86.65
Waterproofing for 135° corners			
KERECK 135 FI 10	4 mil	10 Inside corners	95.76

Schluter®-KERDI-KERS-B

Schluter®-KERDI-KERS-B are preformed, seamless corners for waterproofing 135° angles between triangular shower benches and walls or for curb corners in neo-angle shower applications.

Note: 1 mil = 1 one-thousandth of an inch



Schluter®-KERDI-KERS-B				
Waterproofing corners				
Item No.	Thickness	Description	Packaging	\$ / Package
KERECK 135 FI 2	4 mil	Inside corner, 135°	2 units	20.17
KERECK 135 FI 10	4 mil	Inside corner, 135°	10 units	95.76
KERSB 135 K LR	4 mil	Outside corner, 135°	1 right and 1 left	42.54
KERSB 135 K 5LR	4 mil	Outside corner, 135°	5 right and 5 left	201.99
KERSB 135 K	4 mil	Bench/neo-angle corner kit	1 right and 1 left 135° outside corner, and 2 135° inside corners	62.68

Schluter®-KERDI-KERS

Schluter®-KERDI-KERS are preformed, seamless corners made of Schluter®-KERDI for waterproofing floor/wall/shower base connections in curbless shower applications where the Schluter®-KERDI-LINE linear drain is installed adjacent to the wall.

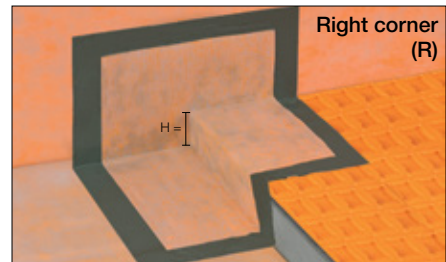
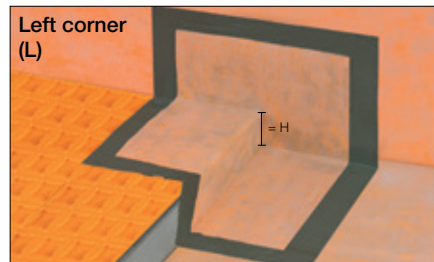

Schluter®-KERDI-KERS				
Waterproofing for corners				
Item No.	H = mm - in.	Thickness	Description	\$ / Unit
KERS 20 L	20 - 3/4	4 mil	Left inside corner	24.47
KERS 28 L	28 - 1-3/32	4 mil	Left inside corner	24.47
KERS 20 R	20 - 3/4	4 mil	Right inside corner	24.47
KERS 28 R	28 - 1-3/32	4 mil	Right inside corner	24.47



Schluter®-KERDI-SEAL-PS/-MV

Schluter®-KERDI-SEAL-PS/-MV pre-fabricated seals are cut sections of the Schluter®-KERDI waterproofing membrane designed to seal protrusions through the Schluter®-KERDI or Schluter®-DITRA/DITRA-XL, as well as Schluter®-KERDI-BOARD building panels. Schluter®-KERDI-SEAL-PS and -MV feature overmolded rubber gaskets and are used to seal pipe protrusions and protect moisture-sensitive solid backing panels at the mixing valve.

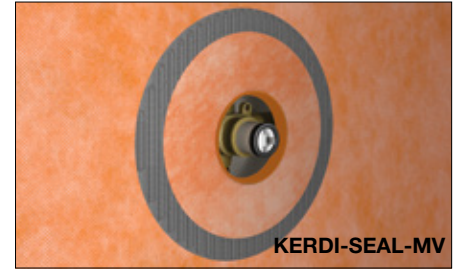
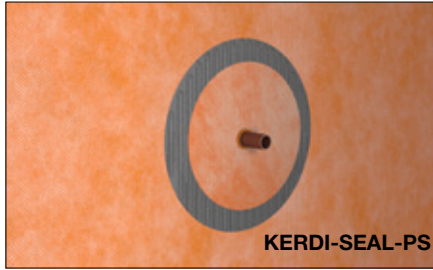

Note: 1 mil = 1 one-thousandth of an inch

Schluter®-KERDI-SEAL-PS				
Pipe seal with overmolded rubber gasket				
Item No.	Pipe nipple opening diam.	Thickness	Packaging	\$ / Package
KMS172/12	12.5 mm - 1/2"	4 mil	1 unit	8.97
KMS172/20	20 mm - 3/4"	4 mil	1 unit	8.97
KMS10172/12	12.5 mm - 1/2"	4 mil	10 units	80.69
KMS10172/20	20 mm - 3/4"	4 mil	10 units	80.69

Schluter®-KERDI-SEAL-MV				
Mixing valve seal with overmolded rubber gasket				
Item No.	Mixing valve opening diam.	Thickness	Packaging	\$ / Package
KMSMV235/114	114 mm - 4-1/2"	4 mil	1 unit	10.34
KMSMV10235/114	114 mm - 4-1/2"	4 mil	10 units	93.11

Schluter®-KERDI-KM

Schluter®-KERDI-KM prefabricated seal is cut sections of the Schluter®-KERDI waterproofing membrane designed to seal protrusions through the KERDI or Schluter®-DITRA/DITRA-XL membranes. KERDI-KM is designed to be used in conjunction with Schluter®-KERDI-FIX or equivalent sealant to seal around pipes or other similar elements.



Schluter®-KERDI-KM				
Pipe seal				
Item No.	Pipe nipple opening diam.	Thickness	Packaging	\$ / Package
KM5117/22	22 mm - 7/8"	4 mil	5 units	10.56

Schluter®-KERDI-FIX

Schluter®-KERDI-FIX is a single-component sealing and bonding compound with a silane-modified polymer base. It is odor-neutral, UV- and weather-resistant, and contains no solvents. KERDI-FIX is elastomeric and bonds well to most materials, such as wood, stone, concrete, metal, glass, and many plastics. KERDI-FIX is suitable for bonding the Schluter®-KERDI waterproofing membrane and Schluter®-KERDI-BAND to fixed building elements. KERDI-FIX is also suitable for use as a sealant.



Schluter®-KERDI-FIX	
Cartridge (290 ml – 9.81 fl oz)	
Item No.	\$ / Unit
KERDIFIX / + color*	30.49

Schluter®-KERDI-FIX	
Tube (100 ml – 3.38 fl oz) - Grey (G)	
Item No.	\$ / Unit
KERDIFIX 100 G	17.71

***Color Codes**

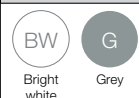

⚠ WARNING: Reproductive Harm www.P65Warnings.ca.gov



Schluter®-REFLEECE

Removable fleece

Whether you want to cover an existing hard surface floor covering for a fresh new look or want to create a temporary floor covering that will be easy to remove in the future, REFLEECE offers a practical solution. The self-adhesive fleece enables the simple removal of coverings without leaving any residue or damaging the subfloor.





Schluter®-REFLEECE

Schluter®-REFLEECE is a removable fleece used to create temporary floor coverings. Made of recycled PET with a self-adhesive coating on the back, REFLEECE measures 1/32" (0.8 mm) thick and is suitable for the application of temporary, removable tile and natural stone coverings. REFLEECE is easy to install and can be removed during deconstruction without causing damage to the existing subfloor. An impact sound improvement value up to 9dB was measured (according to DIN EN ISO 10140) for this assembly. Install with the Schluter®-KERDI-BOARD-ZSA adhesive tape for connecting REFLEECE at the seams.

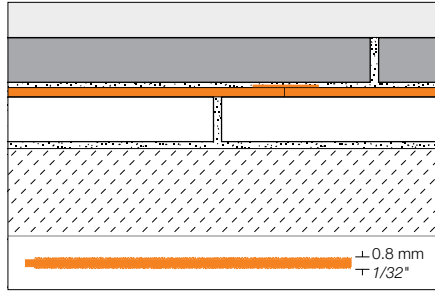

Schluter®-REFLEECE		
Underlayment for temporary floor coverings 0.8 mm - 1/32"		
Item No.	Dimensions	\$ / Roll
REFL 30M	1 m x 30 m = 30 m ² 3' 3" x 98' 5" = 323 ft ²	668.87

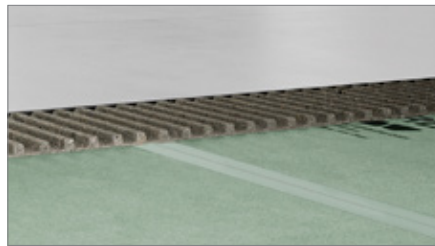

Schluter®-KERDI-BOARD-ZSA			
Joint reinforcement tape			
Item No.	Width	Length	\$ / Roll
KB ZSA 100/45 M	100 mm - 4"	45 m - 148'	19.53



Schluter®-DITRA-HEAT-E

Electric floor warming system with integrated uncoupling technology

Ceramic and stone tiles are the ideal surface coverings because they are durable, easy to maintain, and hygienic. However, two common barriers to the selection of tile as a floor covering are concerns about cracking and the perception that tiles are cold.

DITRA-HEAT integrates customizable, comfortable electric floor warming with the functions associated with DITRA: uncoupling, waterproofing, vapor management and support to ensure a long lasting installation, thereby addressing the two most common concerns.



Schluter®-DITRA-HEAT-PS (page 118)

All the benefits of our original electric floor warming system, now with a peel & stick self-adhesive backing to get the job done even faster.



Schluter®-DITRA-HEAT and DITRA-HEAT-DUO

Schluter®-DITRA-HEAT and **DITRA-HEAT-DUO** are polypropylene membranes with a cut-back stud structure and an anchoring fleece laminated to the underside. Both membranes are designed to secure the DITRA-HEAT-E-HK electric floor heating cables and provide uncoupling, waterproofing, vapor management and support to ensure a long lasting installation.

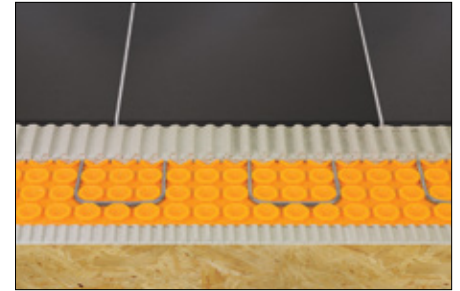
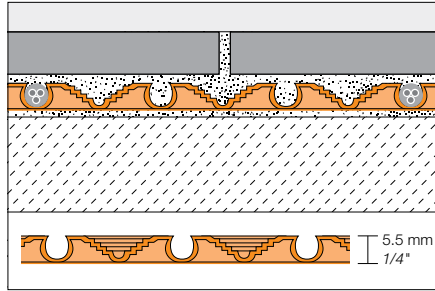

DITRA-HEAT-DUO offers the same functions as DITRA-HEAT, but features a thicker bonding fleece that adds two more benefits, while still supporting the covering to ensure a lasting installation:

Sound Control

DITRA-HEAT-DUO reduces impact sound transmission through floor-ceiling assemblies, making it ideal for multi-story construction. DITRA-HEAT-DUO provides a ΔIIC contribution of 20, when tested per ASTM E2179 in a thin-set assembly with porcelain tile.

Thermal Break

DITRA-HEAT-DUO reduces heat loss to the substrate to improve the floor warming response time over concrete substrates by up to 70%.

The thickness of the mat, including the stud structure, of DITRA-HEAT is 1/4" (5.5 mm) and DITRA-HEAT-DUO is 5/16" (8 mm).

The DITRA-HEAT and DITRA-HEAT-DUO membranes feature cutting grooves, which provide an easy-cut guide and enhanced membrane flexibility.

Schluter®-DITRA-HEAT				
Uncoupling and waterproofing membrane				
Item No.	Dimensions	Format	\$ / ft ² *	\$ / Unit
DH5 12M	0.98 m x 12.76 m = 12.5 m ² 3' 2-5/8" x 41' 10-3/4" = 134.5 ft ²	Roll	2.93	393.42
DH5 MA	0.98 m x 0.8 m = 0.78 m ² 3' 2-5/8" x 2' 7-3/8" = 8.4 ft ²	Sheet	3.04	25.53

* The price per square foot is for estimation purposes only. Please order using the price per roll or per sheet.
Note: The case quantity of DITRA-HEAT sheets (DH5 MA) is 45.

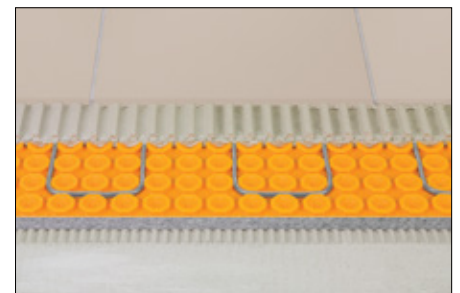
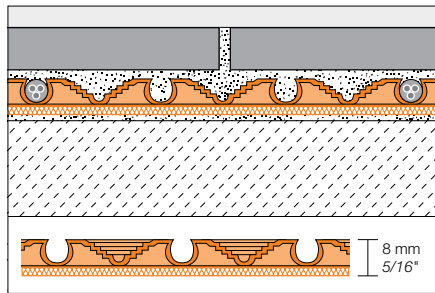

Schluter®-DITRA-HEAT-DUO				
Uncoupling and waterproofing membrane with sound control and thermal break				
Item No.	Dimensions	Format	\$ / ft ² *	\$ / Unit
DHD8 10M	0.98 m x 10.2 m = 10 m ² 3' 2-5/8" x 33' 6-1/2" = 108 ft ²	Roll	4.20	453.23
DHD8 MA	0.98 m x 0.8 m = 0.78 m ² 3' 2-5/8" x 2' 7-3/8" = 8.4 ft ²	Sheet	4.39	36.87

* The price per square foot is for estimation purposes only. Please order using the price per roll or per sheet.
Note: The case quantity of DITRA-HEAT-DUO sheets (DHD8 MA) is 36.



Schluter®-SET, Schluter®-ALL-SET, and Schluter®-FAST-SET
See page 184



Schluter®-DITRA-HEAT/-DITRA-XL-TROWEL
See page 187



Schluter®-DITRA-HEAT-PS and DITRA-HEAT-DUO-PS

Schluter®-DITRA-HEAT-PS and **DITRA-HEAT-DUO-PS** are peel and stick membranes that feature a pressure-sensitive adhesive (PSA) to bond the membrane to the substrate, replacing the need for thin-set mortar. Simply remove the transparent release film from the fleece side of the membrane to expose the layer of adhesive and embed into substrate using a float, screed trowel, or DITRA-ROLLER. The -PS versions offer the same core functions as DITRA-HEAT and DITRA-HEAT-DUO. Both peel and stick membranes are designed to secure the DITRA-HEAT-E-HK electric floor heating cables, and provide uncoupling, waterproofing, vapor management, and load support to ensure a long-lasting tile installation.

DITRA-HEAT-DUO-PS features a thicker bonding fleece that additionally provides sound control to reduce impact sound transmission through floor-ceiling assemblies and a thermal break that reduces heat loss to the substrate to improve floor warming response time, particularly over concrete substrates.

DITRA-HEAT-PS is 1/4" (5.5 mm) -thick and DITRA-HEAT-DUO-PS is 5/16" (8 mm) -thick. Both membranes feature cutting grooves, which provide an easy-cut guide and enhanced membrane flexibility.

A primer is not required to install DITRA-HEAT-PS/-DUO-PS, however, a primer such as Schluter®-PRIMER-U is recommended when installing on a difficult-to-bond-to substrate.

Note: For applications requiring compliance with or certification to the ANSI A118.10 American National Standard Specifications for Load Bearing, Bonded, Waterproof Membranes for Thin-Set Ceramic Tile and Dimension Stone Installation, select the DITRA-HEAT or DITRA-HEAT-DUO membranes that are installed with thin-set mortar. Alternatively, the DITRA-HEAT-PS or DITRA-HEAT-DUO-PS membranes may be covered with the Schluter®-KERDI membrane, which is certified to meet ANSI A118.10.

For complete information, a step-by-step installation video, Installation Handbook, and Technical Data Sheet are available for download at: Schluter.com or by contacting our Customer Service.



Schluter®-PRIMER-U
See page 186

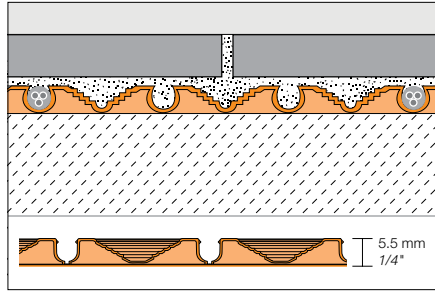

Schluter®-DITRA-HEAT-PS

Peel and stick floor warming

Item No.	Dimensions	Format	\$ / ft ² *	\$ / Unit
DHPS5 12M	0.98 m x 12.76 m = 12.5 m ² 3' 2-5/8" x 41' 10-3/4" = 134.5 ft ²	Roll	3.66	491.76
DHPS5 MA	0.98 m x 0.8 m = 0.78 m ² 3' 2-5/8" x 2' 7-3/8" = 8.4 ft ²	Sheet	3.80	31.92

* The price per square foot is for estimation purposes only. Please order using the price per roll or per sheet.
Note: The case quantity of DITRA-HEAT-PS sheets (DHPS5 MA) is 45.

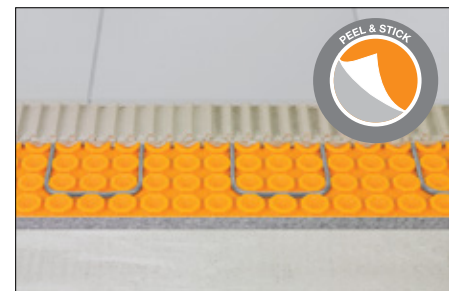
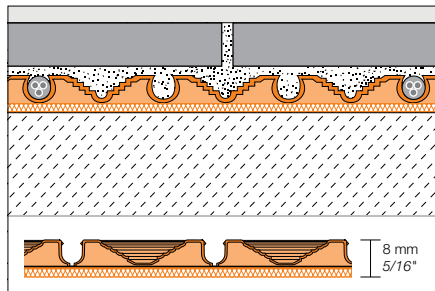

Schluter®-DITRA-HEAT-DUO-PS

Peel and stick floor warming with sound control and thermal break

Item No.	Dimensions	Format	\$ / ft ² *	\$ / Unit
DHPS8 10M	0.98 m x 10.2 m = 10 m ² 3' 2-5/8" x 33' 6-1/2" = 108 ft ²	Roll	5.25	566.55
DHPS8 MA	0.98 m x 0.8 m = 0.78 m ² 3' 2-5/8" x 2' 7-3/8" = 8.4 ft ²	Sheet	5.49	46.09

* The price per square foot is for estimation purposes only. Please order using the price per roll or per sheet.
Note: The case quantity of DITRA-HEAT-DUO-PS sheets (DHPS8 MA) is 36.





Schluter®-DITRA-HEAT-E-HK

Schluter®-DITRA-HEAT-E-HK are twisted pair heating cables designed for integration with the DITRA-HEAT uncoupling membrane in interior floor warming applications. The cables can be installed without returning to the thermostat and produce virtually zero electromagnetic fields.

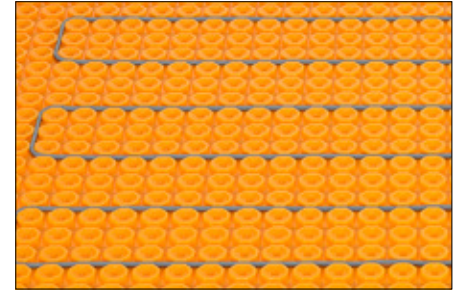

BEFORE ordering heating cables, see IMPORTANT ordering information on page 121.

Schluter®-DITRA-HEAT-E-HK													
Heating cable													
Item No.	Heating Cable Length		Area Covered per Cable Spacing				Total Power (W)	Avg. Power per Unit Area per Cable Spacing				Current (Amps)	\$ / Length
	(ft)	(m)	Regular 3 Stud		Alternating 3-2 Stud			Regular 3 Stud		Alternating 3-2 Stud			
Heating Cable (120 V)													
DHE HK 120 11	35.3	10.8	10.7	1.0	8.9	0.8	135	12.6	136	15.2	164	1.1	224.16
DHE HK 120 16	52.9	16.1	16.0	1.5	13.3	1.2	203	12.7	136	15.2	164	1.7	249.90
DHE HK 120 21	70.5	21.5	21.3	2.0	17.8	1.7	270	12.7	136	15.2	164	2.3	299.81
DHE HK 120 27	88.2	26.9	26.7	2.5	22.2	2.1	338	12.7	136	15.2	164	2.8	321.97
DHE HK 120 32	105.8	32.2	32.0	3.0	26.7	2.5	405	12.7	136	15.2	164	3.4	348.38
DHE HK 120 38	124.1	37.8	37.5	3.5	31.3	2.9	475	12.7	136	15.2	164	4.0	373.34
DHE HK 120 43	141.1	43.0	42.7	4.0	35.6	3.3	540	12.7	136	15.2	164	4.5	395.15
DHE HK 120 51	169.8	51.8	51.4	4.8	42.8	4.0	650	12.7	136	15.2	164	5.4	443.85
DHE HK 120 64	212.9	64.9	64.4	6.0	53.7	5.0	815	12.7	136	15.2	164	6.8	492.24
DHE HK 120 73	240.2	73.2	72.7	6.8	60.6	5.6	920	12.7	136	15.2	164	7.7	541.05
DHE HK 120 83	275.5	84.0	83.3	7.7	69.4	6.5	1055	12.7	136	15.2	164	8.8	606.81
DHE HK 120 92	303.0	92.4	91.7	8.5	76.4	7.1	1160	12.7	136	15.2	164	9.7	662.48
DHE HK 120 102	336.9	102.7	101.9	9.5	84.9	7.9	1290	12.7	136	15.2	164	10.7	728.99
DHE HK 120 113	372.2	113.4	112.6	10.5	93.8	8.7	1425	12.7	136	15.2	164	11.9	796.11
DHE HK 120 134	444.0	135.3	134.3	12.5	111.9	10.4	1700	12.7	136	15.2	164	14.2	871.02
Heating Cable (240 V)													
DHE HK 240 11	35.3	10.8	10.7	1.0	8.9	0.8	135	12.6	136	15.2	164	0.6	224.16
DHE HK 240 16	53.1	16.2	16.1	1.5	13.4	1.2	203	12.6	136	15.2	164	0.8	249.76
DHE HK 240 21	70.6	21.5	21.4	2.0	17.8	1.7	270	12.7	136	15.2	164	1.1	299.83
DHE HK 240 27	88.2	26.9	26.7	2.5	22.2	2.1	338	12.7	136	15.2	164	1.4	321.96
DHE HK 240 32	105.8	32.2	32.0	3.0	26.7	2.5	405	12.7	136	15.2	164	1.7	348.38
DHE HK 240 38	124.1	37.8	37.5	3.5	31.3	2.9	475	12.7	136	15.2	164	2.0	373.39
DHE HK 240 43	141.0	43.0	42.6	4.0	35.5	3.3	540	12.7	136	15.2	164	2.3	395.22
DHE HK 240 53	176.3	53.7	53.3	5.0	44.4	4.0	675	12.7	136	15.2	164	2.8	443.70
DHE HK 240 64	211.6	64.5	64.0	5.9	53.3	5.0	810	12.7	136	15.2	164	3.4	492.41
DHE HK 240 75	248.2	75.7	75.1	7.0	62.6	5.8	950	12.7	136	15.2	164	4.0	540.79
DHE HK 240 85	282.1	86.0	85.3	7.9	71.1	6.6	1080	12.7	136	15.2	164	4.5	590.95
DHE HK 240 103	339.4	103.4	102.7	9.5	85.6	7.9	1300	12.7	136	15.2	164	5.4	664.58
DHE HK 240 129	425.8	129.8	128.8	12.0	107.3	10.0	1630	12.7	136	15.2	164	6.8	742.32
DHE HK 240 145	480.5	146.5	145.3	13.5	121.1	11.3	1840	12.7	136	15.2	164	7.7	807.23
DHE HK 240 167	551.0	167.9	166.7	15.5	138.9	12.9	2110	12.7	136	15.2	164	8.8	870.34
DHE HK 240 183	605.9	184.7	183.3	17.0	152.7	14.2	2320	12.7	136	15.2	164	9.7	950.68
DHE HK 240 204	673.8	205.4	203.8	18.9	169.9	15.8	2580	12.7	136	15.2	164	10.7	1,023.72
DHE HK 240 225	744.4	226.9	225.2	20.9	187.7	17.4	2850	12.7	136	15.2	164	11.9	1,099.92

Each heating cable includes 2 floor temperature sensors compatible with the Schluter®-DITRA-HEAT-E thermostats and features an approximately 7 ft (2.1 m) long cold lead.



Schluter®-DITRA-HEAT-E-HK Heating Cables 208 V Applications

Schluter®-DITRA-HEAT offers complete flexibility when creating warm floors in any application. DITRA-HEAT-E-HK heating cables are designed for use with common 120 V and 240 V power sources. 208 V power sources are used in some cases to handle larger loads (e.g., HVAC equipment, motors, etc.) or to improve energy efficiency.

Schluter-Systems recommends using the DITRA-HEAT-E-HK 240 V heating cables when a 208 V power source is present. However, this will reduce the heating power by 25% to 9.5 W/ft² at the standard 3-stud cable spacing, which may not be sufficient power to warm the floor in these applications. To offset the effect

of the lower voltage, we recommend installing the heating cable at a 2-stud spacing in these applications. This results in an increased heating power of 14.2 W/ft², which will ensure adequate performance.

The heating cable will cover 33% less area when spaced at 2 studs compared to 3 studs. Therefore, a longer heating cable must be selected to cover a given area in these applications. Coverage for each 240 V heating cable spaced at 2 studs can be found in the table below.



DITRA-HEAT-E-HK 240 V Heating Cables in 208 V Applications at 2 Stud Spacing

Item No.	Length (ft - m)	Area (ft ² - m ²)	Power (W)	Average Power (W/ft ² - W/m ²)	Current (A)
DHE HK 240 11	35.3 – 10.8	7.1 – 0.7	101	14.2 - 152.8	0.5
DHE HK 240 16	53.1 – 16.2	10.7 – 1.0	152	14.2 - 152.8	0.7
DHE HK 240 21	70.5 – 21.5	14.2 – 1.3	203	14.2 - 152.8	1.0
DHE HK 240 27	88.2 – 26.9	17.8 – 1.7	254	14.2 - 152.8	1.2
DHE HK 240 32	105.8 – 32.2	21.3 – 2.0	304	14.2 - 152.8	1.5
DHE HK 240 38	124.1 – 37.8	25.0 – 2.3	356	14.2 - 152.8	1.7
DHE HK 240 43	141 – 43.0	28.4 – 2.6	405	14.2 - 152.8	1.9
DHE HK 240 53	176.3 – 53.7	35.5 – 3.3	506	14.2 - 152.8	2.4
DHE HK 240 64	211.6 – 64.5	42.7 – 4.0	608	14.2 - 152.8	2.9
DHE HK 240 75	248.2 – 75.7	50.0 – 4.7	713	14.2 - 152.8	3.4
DHE HK 240 85	282.1 – 86.0	56.9 – 5.3	810	14.2 - 152.8	3.9
DHE HK 240 103	339.4 – 103.4	68.4 – 6.4	975	14.2 - 152.8	4.7
DHE HK 240 129	425.8 – 129.8	85.8 – 8.0	1223	14.2 - 152.8	5.9
DHE HK 240 145	480.5 – 146.5	96.9 – 9.0	1380	14.2 - 152.8	6.6
DHE HK 240 167	551 – 167.9	111.1 – 10.3	1583	14.2 - 152.8	7.6
DHE HK 240 183	605.9 – 184.7	122.1 – 11.4	1740	14.2 - 152.8	8.4
DHE HK 240 204	673.8 – 205.4	135.8 – 12.6	1935	14.2 - 152.8	9.3
DHE HK 240 225	744.4 – 226.9	150.1 – 13.9	2138	14.2 - 152.8	10.3

We recommend consulting with a qualified electrician for design and installation of your DITRA-HEAT system on a 208 V power source. Keep in mind during design of the system that the DITRA-HEAT-E thermostats have an electrical current limit of 15 A.



IMPORTANT Ordering Information for Schluter®-DITRA-HEAT Cables

- Do not purchase a heating cable the same size as the area to be tiled; this will be too much heating cable!
- Very important: **Never CUT or modify the heating cable in any way.** This would change the cable resistance, will cause damage to the cable, and could cause cable overheating.
- A cable spacing of 3 studs is standard
- Cable may also be spaced at continuously alternating 3 stud – 2 stud – 3 stud intervals in isolated areas or over the entire floor. This practice may be desirable to increase heat output (e.g., over uninsulated on or below grade concrete subfloors) or to consume more cable length in a given area (e.g., when using the standard 3 stud spacing doesn't allow the selected cable to fit the floor area and respect minimum spacing requirements from walls, partitions, etc.)
- A cable spacing of 4 studs is not recommended, as it can produce inconsistent floor surface temperatures
- Minimum spacing from walls, partitions, and fixed cabinets is 2" (50 mm).
- Minimum spacing from other heat sources (baseboard heaters, fireplaces, etc.) is 8" (200 mm).
- Minimum spacing from any plumbing drain and forced air heating ducts is 4" (100 mm).
- Minimum spacing from the centerline of toilet drain is 7" (180 mm).
- The heating section of the cable must be entirely installed under the floor covering. The installation is characterized as a Type C (Embedded Floor Warming) application. In order to prevent a fire hazard, do not install it anywhere else (e.g. in a wall).
- NEVER install the heating cable under vanities with no air space beneath, bathtub platforms, free-standing bathtubs with no air space beneath, kitchen cabinets or any other fixtures or in clothing closets. Excessive heat will build up in these confined spaces and may cause cable overheating.
- It is helpful to plan the location of a buffer zone, as it is not possible to predict where the heating cable will end. The buffer zone is an area where heating is not essential and heating cable installation is not planned (e.g., behind a toilet or adjacent to a door opening). This area allows for placement of excess heating cable. Heating cables may also be installed 6" (150 mm) from the wall to create a buffer zone.
- Heating cable testing is required while the heating cable is on the spool and at two subsequent steps during installation to ensure cable quality and for warranty purposes.

Schluter®-DITRA-HEAT-E-HK-RK Heating Cable Repair Kit and Schluter®-DITRA-HEAT-E-HK-SK Heating Cable Splice Kit

Schluter®-DITRA-HEAT-E-HK-RK is a repair kit for DITRA-HEAT-E-HK heating cables. The kit contains all the material to replace one section of heating cable (gray section) up to 10" (25 cm) long or less in the event of damage, such as cuts by other trades during installation.

Schluter®-DITRA-HEAT-E-HK-SK is a splice kit for DITRA-HEAT-E-HK heating cables. The kit contains all the material to replace one factory splice of the heating cable.

Please visit www.schluter.com for ordering information.

WARNINGS

- Heating cable repairs must be conducted by a qualified electrician in accordance with this heating cable repair procedure, the National Electric Code (USA) or Canadian Electric Code Part I (CAN) as applicable and the Schluter®-DITRA-HEAT Installation Handbook. All electrical connections must be made by a qualified electrician, according to the electrical and building codes effective in your region.
- **Prior to commencing a repair:** Any known deviations from the Schluter®-DITRA-HEAT Installation Handbook and/or applicable code(s) must be corrected. All cable installation and repair instructions must be followed in order to avoid personal injuries or property damage.
- Do not use these kits to splice different heating cables together. These kits are only intended for making repairs to a single cable.
- The heating cable cannot be shortened or altered to fit.
- **Very important:** Never CUT the heating cable. This could change the cable resistance and could lead to a fire.
- **WARRANTY DISCLAIMER:** Any deviation from the DITRA-HEAT Installation Handbook (which includes damage to the DITRA-HEAT-E-HK heating cables) voids the Schluter®-DITRA-HEAT Limited limited Warranty and warranty coverage is not reinstated upon repair of the heating cable. SCHLUTER SYSTEMS FURTHER DISCLAIMS ANY AND ALL WARRANTIES EXPRESSED OR IMPLIED, INCLUDING BUT NOT LIMITED TO THE IMPLIED WARRANTIES OF MERCHANTABILITY OR FITNESS FOR A PARTICULAR PURPOSE AND ANY AND ALL LIABILITY ARISING FROM THE ELECTRICIAN SERVICES.



Schluter®-DITRA-HEAT-E Thermostats

Schluter®-DITRA-HEAT-E digital thermostats control the DITRA-HEAT-E-HK heating cables (both 120 V and 240 V). All thermostats feature a 5 mA built-in ground fault circuit interrupter (GFCI) with indicator light, and have an electrical current limit of 15 amps.

Schluter®-DITRA-HEAT-E-WiFi programmable Wi-Fi thermostat offers all the same features as the Programmable Touchscreen model, with additional Wi-Fi functionality that enables the user to control the DITRA-HEAT electric floor warming system from a mobile app or online.

Schluter®-DITRA-HEAT-E-RT programmable touchscreen thermostat features six programming periods per day, a set-up wizard, energy log, and a QR code for quick access to system settings.

Schluter®-DITRA-HEAT-E-R non-programmable version features simple on/off functionality.

Schluter®-DITRA-HEAT-E-WiFi		
Touchscreen programmable Wi-Fi digital floor thermostat		
Item No.	Description	\$ / Unit
DHE RT 104/BW	Touchscreen programmable Wi-Fi thermostat in bright white	350.51

according to the following standards: UL 60730-1, UL 60730-2-9, CSA E60730-1, CSA E60730-2-9, UL E-file: E157297, GFCI: UL 943 4th ed., CSA C22.2 No. 144.1-06



Wi-Fi

Schluter®-DITRA-HEAT-E-RT		
Touchscreen programmable digital floor thermostat		
Item No.	Description	\$ / Unit
DHE RT 102/BW	Touchscreen programmable thermostat in bright white	275.57

according to the following standards: UL 60730, CSA E60730-1, UL E-file: E157297, GFCI: UL 943, CSA C22.2 No.144.1-06



RT

Schluter®-DITRA-HEAT-E-R		
Non-programmable digital floor thermostat		
Item No.	Description	\$ / Unit
DHE RT 103/BW	Non-programmable thermostat in bright white	193.38

according to the following standards: UL 60730, CSA E60730-1, UL E-file: E157297, GFCI: UL 943, CSA C22.2 No.144.1-06



R

Schluter®-DITRA-HEAT-E-RR

Schluter®-DITRA-HEAT-E-RR is a power module that extends power output when used in conjunction with the DITRA-HEAT-E-WiFi, -RT, or -R thermostats. The power module is designed to be used in large floor applications where the heating load exceeds 15 amps, in order to maintain a single point of control. Up to 16 DITRA-HEAT-E-RR power modules may be connected in series via low voltage signal wire to a single DITRA-HEAT-E-WiFi, -RT, or -R thermostat. The power module also features a 5 mA built-in GFCI.

Schluter®-DITRA-HEAT-E-RR		
Power module		
Item No.	Description	\$ / Unit
DHE RR 1/BW	Power module	169.21

according to the following standards: CSA E60730-1, GFCI: UL 943, CSA C22.2 No.144.1-06





Smart Thermostat for the DITRA-HEAT Floor Warming System



Schluter®-DITRA-HEAT-E-RS1 Smart Thermostat

Schluter®-DITRA-HEAT-E-RS1 smart thermostat features a sleek, versatile design with a mirror finish, and third-party integration with popular voice and home assistants to easily include floor warming into your smart home capabilities. Works with Apple Home, Google Home, and Alexa. Download the Schluter Smart Thermostat app to get convenient, remote access to your DITRA-HEAT floor warming system. The DITRA-HEAT-E-RS1 thermostat controls both the 120 V and 240 V DITRA-HEAT-E-HK heating cables. It features a Class A (5 mA) built-in ground fault circuit interrupter (GFCI) with indicator light and has an electrical current limit of 15 amps.



RS1

Schluter®-DITRA-HEAT-E-RS1

Smart digital floor thermostat

Item No.	Description	\$ / Unit
DHE RT 105/BW	Smart thermostat with Wi-Fi, app, & voice control	357.73



Certified to the following standards: UL 60730-1, UL 60730-2-9, UL 943, CAN/CSA E60730-1, CAN/CSA-E60730-2-9, CSA C22.2 No.144.1



Schluter®-DITRA-HEAT-E-RRS

Schluter®-DITRA-HEAT-E-RRS is a power module specifically designed for the DITRA-HEAT-E-RS1 smart thermostat. The power module may be used when the heating load exceeds 15 amps (e.g., in large floor applications) to maintain a single point of control. Features an input and output voltage of 120 V, 208 V, or 240 V, and a control input from the thermostat of 24 Vdc. The power module also includes a built-in class A GFCI.



Schluter®-DITRA-HEAT-E-RRS

Power module

Item No.	Description	\$ / Unit
DHE RR 2/BW	Power module	190.65



Certified to the following standards: UL 60730-1, UL 60730-2-9, UL 943, CAN/CSA E60730-1, CAN/CSA-E60730-2-9, CSA C22.2 No.144.1



Schluter®-Shower System

Complete waterproofing system for tiled showers

Schluter Systems provides an integrated family of products in which the individual components collectively form a bonded watertight assembly. The Schluter-Shower System eliminates the risk of failures due to both vapor and water penetration, is maintenance-free, and dramatically reduces total installation time.





Waterproofing

Waterproofing membranes provide protection—and peace-of-mind—behind your shower walls and other tiled elements subject to moisture.

KERDI and KERDI-DS are pliable, sheet-applied, bonded waterproof membranes and vapor retarders with limited crack-bridging capabilities. Accessories made out of KERDI, including waterproofing strips, seamless corners, and pipe and mixing valve seals help complete the waterproofing process to ensure that your shower or bath surround is well-protected against mold and mildew.

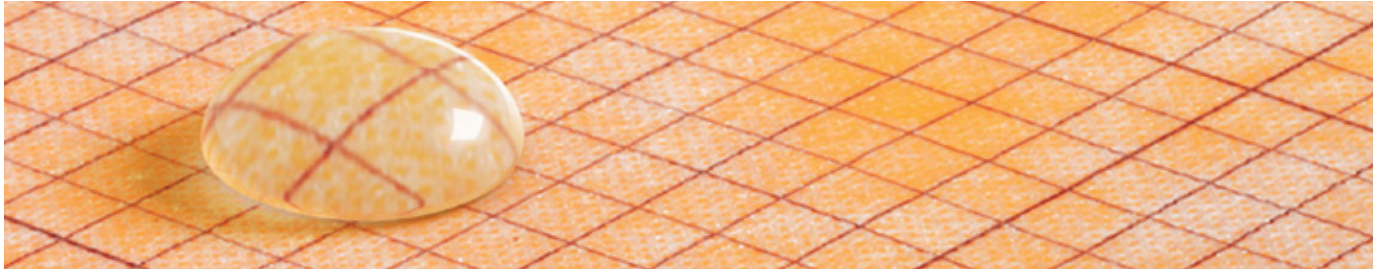

Schluter®-KERDI and Schluter®-KERDI-DS

Schluter®-KERDI is a pliable sheet-applied polyethylene waterproofing membrane and vapor retarder that guarantees uniform thickness. It is covered with an anchoring fleece on both sides to anchor the membrane in thin-set mortar and is suitable for waterproofing in conjunction with tiled surfaces on walls and floors. KERDI is 8-mil thick and has a water vapor permeance of 0.90 perms, when tested according to ASTM E96, using Procedure E at 90% relative humidity.

Schluter®-KERDI-DS is a bonded waterproofing membrane and vapor retarder with very low water vapor permeance for use in continuous use steam rooms and similar applications. KERDI-DS is 20-mil thick and features additives to produce a water vapor permeance of 0.19 perms, when tested according to ASTM E96, using Procedure E at 90% relative humidity.

KERDI and KERDI-DS meet the American National Standard for Load Bearing, Bonded, Waterproof Membranes for Thin-Set Ceramic Tile and Dimension Stone Installations (ANSI A118.10). The membranes are listed by cJPC® and evaluated by ICC-ES (Report Nos. ESR-2467 and PMG-1204).

KERDI and KERDI-DS have been evaluated according to the "Standard Method for the Testing and Evaluation of Volatile Organic Chemical Emissions from Indoor Sources Using Environmental Chambers, Version 1.1" for California Specification 01350 and found to comply with the VOC requirements. California Specification 01350 is referenced by various green building standards and rating systems.

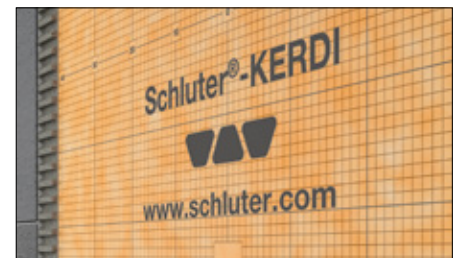
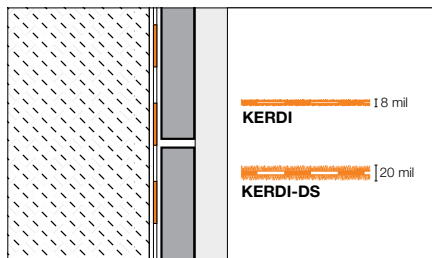

Note: 1 mil = 1 one-thousandth of an inch

Schluter®-KERDI			
Waterproofing membrane			
Item No.	Dimensions	\$ / ft ² *	\$ / Roll
Roll width: 1 m - 3' 3"			
KERDI 200/5M	1 m x 5 m = 5 m ² - 3' 3" x 16' 5" = 54 ft ²	2.35	127.08
KERDI 200/7M	1 m x 7 m = 7 m ² - 3' 3" x 23' = 75 ft ²	2.32	174.05
KERDI 200/10M	1 m x 10 m = 10 m ² - 3' 3" x 33' = 108 ft ²	2.28	246.75
KERDI 200/20M	1 m x 20 m = 20 m ² - 3' 3" x 65' 7" = 215 ft ²	2.19	471.57
KERDI 200	1 m x 30 m = 30 m ² - 3' 3" x 98' 5" = 323 ft ²	2.06	664.85
Roll width: 2 m - 6' 7"			
KERDI 200200/15M	2 m x 15 m = 30 m ² - 6' 7" x 49' 2-1/2" = 323 ft ²	2.06	664.85
KERDI 200200	2 m x 30 m = 60 m ² - 6' 7" x 98' 5" = 646 ft ²	1.97	1,273.83

Schluter®-KERDI-DS			
Waterproofing membrane			
Item No.	Dimensions	\$ / ft ² *	\$ / Roll
KERDI-DS	1 m x 30 m = 30 m ² - 3' 3" x 98' 5" = 323 ft ²	2.79	902.28

* The price per square foot is for estimation purposes only. Please order using the price per roll.



Schluter®-SET, Schluter®-ALL-SET, and Schluter®-FAST-SET
See page 184



Schluter®-KERDI-TROWEL
See page 187

Schluter®-KERDI-BAND

Schluter®-KERDI-BAND is a waterproofing strip used to seal butt joints and floor/wall connections with the Schluter®-KERDI, DITRA, and DITRA-HEAT membranes, as well as joints, corners, and fastener penetrations with the Schluter®-KERDI-BOARD building panels.

Note: 1 mil = 1 one-thousandth of an inch

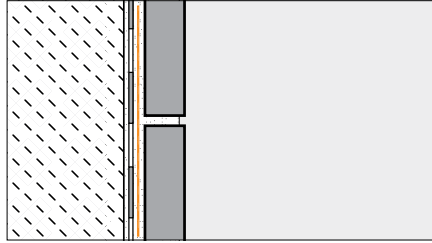

Schluter®-KERDI-BAND					
Waterproofing strip					
Item No.	Width	Length	Thickness	\$/ ft *	\$/ Roll
125 mm - 5" width					
KEBA 100/125/5M	125 mm - 5"	5 m - 16' 5"	4 mil	1.44	23.59
KEBA 100/125/10M	125 mm - 5"	10 m - 33'	4 mil	1.36	44.80
KEBA 100/125	125 mm - 5"	30 m - 98' 5"	4 mil	1.12	110.71
KEBA100/125/300	125 mm - 5"	300 m - 984' 3"	4 mil	1.01	996.46
185 mm - 7-1/4" width					
KEBA 100/185/5M	185 mm - 7-1/4"	5 m - 16' 5"	4 mil	1.88	30.89
KEBA 100/185	185 mm - 7-1/4"	30 m - 98' 5"	4 mil	1.56	153.05
250 mm - 10" width					
KEBA 100/250/5M	250 mm - 10"	5 m - 16' 5"	4 mil	2.35	38.50
KEBA 100/250	250 mm - 10"	30 m - 98' 5"	4 mil	2.00	196.79

* The price per foot is for estimation purposes only. Please order using the price per roll.

Schluter®-KERDI-KERECK-F

Schluter®-KERDI-KERECK-F are preformed, seamless corners made of Schluter®-KERDI for waterproofing inside and outside corners.

Note: 1 mil = 1 one-thousandth of an inch

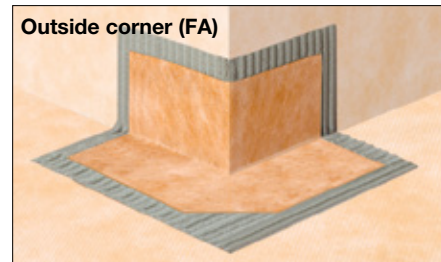
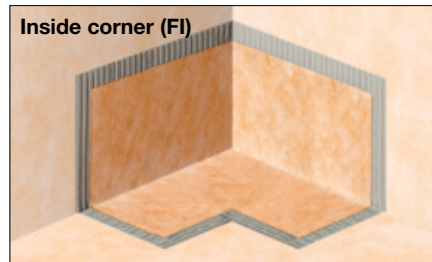

Schluter®-KERDI-KERECK-F			
Waterproofing for 90° corners			
Item No.	Thickness	Packaging	\$/ Package
KERECK/FI 2	4 mil	2 Inside corners	18.20
KERECK/FA 2	4 mil	2 Outside corners	18.20
Waterproofing for 135° corners			
KERECK 135 FI 2	4 mil	2 Inside corners	20.17

Schluter®-KERDI-KERECK-F			
Waterproofing for 90° corners			
Item No.	Thickness	Packaging	\$/ Package
KERECK/FI 10	4 mil	10 Inside corners	86.65
KERECK/FA 10	4 mil	10 Outside corners	86.65
Waterproofing for 135° corners			
KERECK 135 FI 10	4 mil	10 Inside corners	95.76



Schluter®-KERDI-KERS-B

Schluter®-KERDI-KERS-B are preformed, seamless corners for waterproofing 135° angles between triangular shower benches and walls or for curb corners in neo-angle shower applications.

Note: 1 mil = 1 one-thousandth of an inch



Schluter®-KERDI-KERS-B				
Waterproofing corners				
Item No.	Thickness	Description	Packaging	\$ / Package
KERECK 135 FI 2	4 mil	Inside corner, 135°	2 units	20.17
KERECK 135 FI 10	4 mil	Inside corner, 135°	10 units	95.76
KERSB 135 K LR	4 mil	Outside corner, 135°	1 right and 1 left	42.54
KERSB 135 K 5LR	4 mil	Outside corner, 135°	5 right and 5 left	201.99
KERSB 135 K	4 mil	Bench/neo-angle corner kit	1 right and 1 left 135° outside corner, and 2 135° inside corners	62.68

Schluter®-KERDI-KERS

Schluter®-KERDI-KERS are preformed, seamless corners made of Schluter®-KERDI for waterproofing floor/wall/shower base connections in curbless shower applications where the Schluter®-KERDI-LINE linear drain is installed adjacent to the wall.

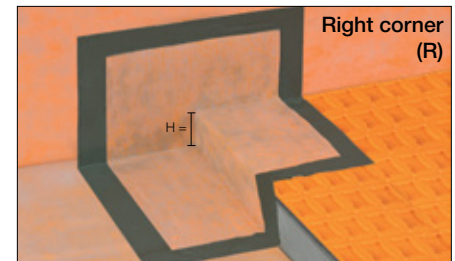
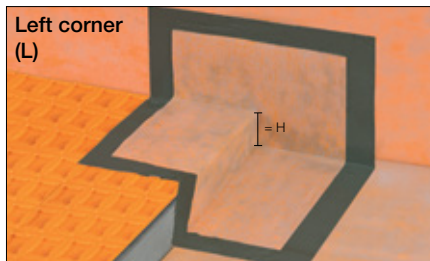

Schluter®-KERDI-KERS				
Waterproofing for corners				
Item No.	H = mm - in.	Thickness	Description	\$ / Unit
KERS 20 L	20 - 3/4	4 mil	Left inside corner	24.47
KERS 28 L	28 - 1-3/32	4 mil	Left inside corner	24.47
KERS 20 R	20 - 3/4	4 mil	Right inside corner	24.47
KERS 28 R	28 - 1-3/32	4 mil	Right inside corner	24.47

Schluter®-KERDI-SEAL-PS/-MV

Schluter®-KERDI-SEAL-PS/-MV prefabricated seals are cut sections of the Schluter®-KERDI waterproofing membrane designed to seal protrusions through the Schluter®-KERDI or Schluter®-DITRA/DITRA-XL, as well as Schluter®-KERDI-BOARD building panels. Schluter®-KERDI-SEAL-PS and -MV feature overmolded rubber gaskets and are used to seal pipe protrusions and protect moisture-sensitive solid backing panels at the mixing valve.

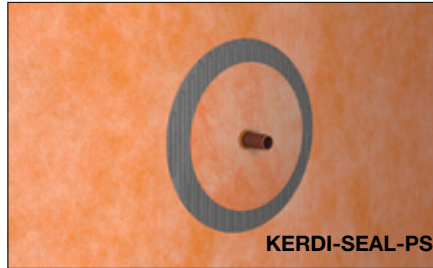

KERDI-SEAL-PS

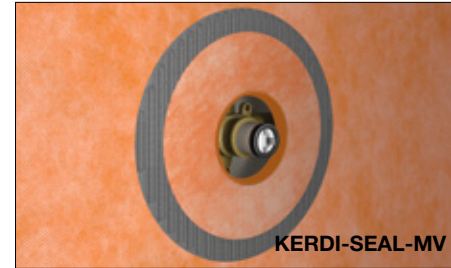

KERDI-SEAL-MV

Note: 1 mil = 1 one-thousandth of an inch

Schluter®-KERDI-SEAL-PS**Pipe seal with overmolded rubber gasket**

Item No.	Pipe nipple opening diam.	Thickness	Packaging	\$ / Package
KMS172/12	12.5 mm - 1/2"	4 mil	1 unit	8.97
KMS172/20	20 mm - 3/4"	4 mil	1 unit	8.97
KMS10172/12	12.5 mm - 1/2"	4 mil	10 units	80.69
KMS10172/20	20 mm - 3/4"	4 mil	10 units	80.69

Schluter®-KERDI-SEAL-MV**Mixing valve seal with overmolded rubber gasket**

Item No.	Mixing valve opening diam.	Thickness	Packaging	\$ / Package
KMSMV235/114	114 mm - 4-1/2"	4 mil	1 unit	10.34
KMSMV10235/114	114 mm - 4-1/2"	4 mil	10 units	93.11

Schluter®-KERDI-KM

Schluter®-KERDI-KM prefabricated seal is cut sections of the Schluter®-KERDI waterproofing membrane designed to seal protrusions through the KERDI or Schluter®-DITRA/DITRA-XL membranes. KERDI-KM is designed to be used in conjunction with Schluter®-KERDI-FIX or equivalent sealant to seal around pipes or other similar elements.

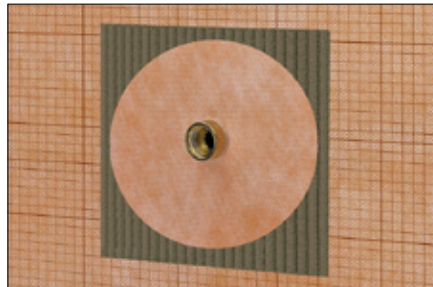
**Schluter®-KERDI-KM****Pipe seal**

Item No.	Pipe nipple opening diam.	Thickness	Packaging	\$ / Package
KM5117/22	22 mm - 7/8"	4 mil	5 units	10.56



Schluter®-KERDI-DRAIN

Point drain with integrated bonding flange

Schluter®-KERDI-DRAIN is a shower drain with an integrated bonding flange that provides a large contact area for a secure connection to the KERDI waterproofing membrane at the top of the assembly. The grate assembly can be seamlessly adjusted to the thickness and layout of the ceramic tile or stone covering. KERDI-DRAIN is available with several grate designs, including a frameless tileable covering support, and offered in nine TRENDLINE colors to match with Schluter®-SHELF (page 166), trim profiles, and fixtures.





Schluter®-KERDI-DRAIN and Schluter®-KERDI-DRAIN-H

Schluter®-KERDI-DRAIN and **KERDI-DRAIN-H** are floor drains with an integrated bonding flange that provides a large contact area for a secure connection to the Schluter®-KERDI waterproofing membrane at the top of the assembly. Both KERDI-DRAIN and KERDI-DRAIN-H are appropriate for both mortar bed and Schluter®-KERDI-SHOWER-T/-TS/-TT shower tray applications. The bonding flange is sloped to simplify installation of the mortar bed.

The KERDI-DRAIN flange provides a vertical connection to the drain pipe and is available in ABS or PVC with 2" or 3" (50 or 75 mm) outlet, and stainless steel with a 2" or 3" (50 or 75 mm) no-hub outlet or 2" (50 mm) threaded outlet.

The KERDI-DRAIN-H flange provides a horizontal connection to the drain pipe and is available in ABS or PVC with a 2" (50 mm) outlet. It is ideal for applications where the use of a vertical connection to the drain pipe is not possible or practical (e.g., suspended or post-tension concrete floors, basement slabs, or wood floor installations where relocating the hole in the floor is not practical). The horizontal outlet allows the positioning of the drain in the desired area regardless of drain pipe location.

A compensation board is available for use with KERDI-DRAIN-H in conjunction with the KERDI-SHOWER-T/-TS/-TT shower trays.

KERDI-DRAIN and KERDI-DRAIN-H feature a fully adjustable grate (available in stainless steel and anodized aluminum in various finishes) that accommodates a wide range of tile thicknesses: 1/4" (6 mm) to 1-1/4" (32 mm); or a tileable covering support that accommodates any tile thickness and creates a virtually invisible drainage line. The grate assembly allows lateral and tilt adjustment as well. Please note that grate assemblies used with the plastic KERDI-DRAIN featuring 3" (75 mm) outlets only allow vertical and tilt adjustment (no lateral adjustment). 6" (150 mm)-square stainless steel covers are also available for installations where KERDI-DRAIN or KERDI-DRAIN-H are to be used in a cleanout application.

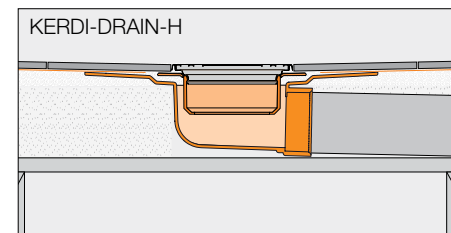
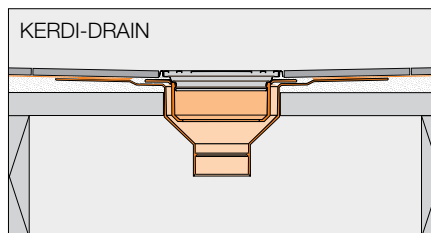
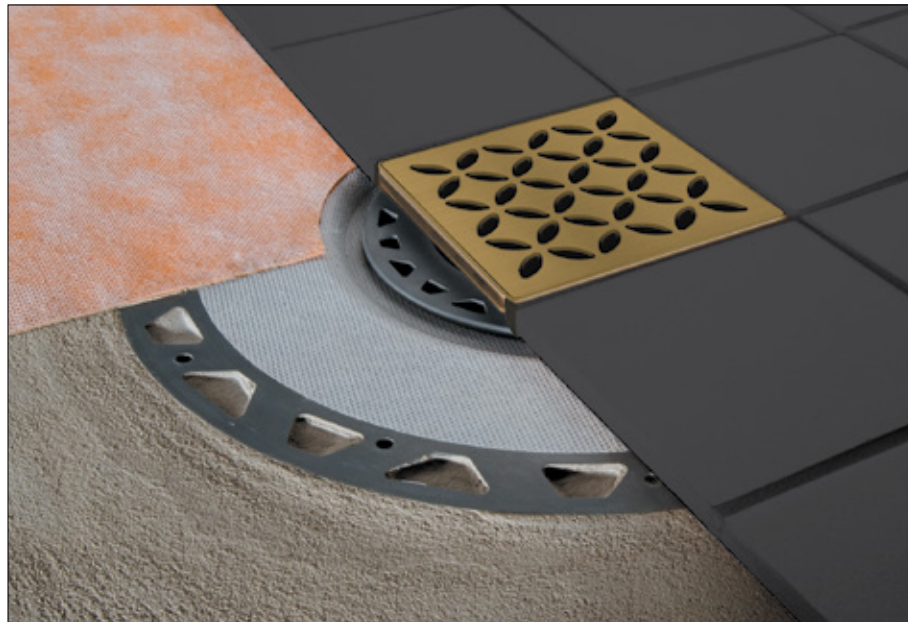



Selecting your Schluter®-KERDI-DRAIN

Schluter®-KERDI-DRAIN flanges and grates are sold separately.

1 Select your grate from pages 132 - 135.

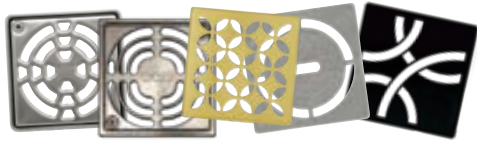

2 Select the flange appropriate for your application from the tables on pages 136 - 139.



- When using a flange with a 3" (75 mm) outlet, a 6" (150 mm) grate is recommended.
- When using the KERDI-DRAIN-F flange or the KERDI-DRAIN-A flange with 5-1/4" (133.4 mm) adaptor ring, the 4" (100 mm) tileable grate and 6" (150 mm) round and square grates are not suitable.

Schluter®-KERDI-DRAIN - Listings and Certifications									
Flanges	Grates	Grate - 4" (100 mm)				STYLE PURE, CURVE and FLORAL Stainless steel (All finishes)	Grate - 6" (150 mm)		
		CLASSIC Stainless steel (All finishes except EOB)	CLASSIC Stainless steel EOB	CONTOUR Anodized aluminum (All finishes)	TILE		Stainless steel		
							Square 6E	Round 6RE	Cover 6CE
2" (50 mm) PVC		1	-	1	1	1	1	2	
2" (50 mm) ABS		1	-	1	1	1	1	2	
2" (50 mm) PVC Horizontal		1	-	1	1	1	1	2	
2" (50 mm) ABS Horizontal		1	-	1	1	1	1	2	
2" (50 mm) Stainless steel		1	-	1	1	1	1	2	
2" (50 mm) Stainless steel Threaded		1	-	1	1	1	1	2	
3" (75 mm) PVC		-	-	-	-	1	1	2	
3" (75 mm) ABS		-	-	-	-	1	1	2	
3" (75 mm) Stainless steel		-	-	-	-	1	1	2	
5-1/4" (133.4 mm) Adaptor		-	-	-	-	-	-	-	
7-1/2" (191 mm) Adaptor		-	-	-	-	-	-	-	

Various configurations of KERDI-DRAIN are listed by ICC-ES (Report No. PMG-1204), UPC® and CSA as shown in the table above.

1 - Listed by ICC-ES (Report No. PMG-1204), UPC® and CSA.

2 - Listed by CSA

For copies of these documents, please contact Schluter®-Systems at 800-472-4588 or by email at info@schluter.com.

Links to the documents can also be accessed at Schluter.com.



GRATES FOR USE WITH FLANGES WITH 2" (50 MM) OUTLET

Schluter®-KERDI-DRAIN-STYLE - Metallic finishes

Stainless Steel



EB EBT EBRG EBVG EBCG

PURE		100 mm - 4"
Grate finish	Item No.	\$ / Unit
Brushed stainless steel (EB)	KDIF4 GRK EB D8	102.54
Brushed nickel (EBT)	KDIF4 GRK EBT D8	161.62
Brushed rose gold (EBRG)	KDIF4 GRK EBRG D8	161.62
Brushed vintage gold (EBVG)	KDIF4 GRK EBVG D8	161.62
Brushed classic gold (EBCG)	KDIF4 GRK EBCG D8	161.62





EB EBT EBRG EBVG EBCG

CURVE		100 mm - 4"
Grate finish	Item No.	\$ / Unit
Brushed stainless steel (EB)	KDIF4 GRK EB D6	102.54
Brushed nickel (EBT)	KDIF4 GRK EBT D6	161.62
Brushed rose gold (EBRG)	KDIF4 GRK EBRG D6	161.62
Brushed vintage gold (EBVG)	KDIF4 GRK EBVG D6	161.62
Brushed classic gold (EBCG)	KDIF4 GRK EBCG D6	161.62



EB EBT EBRG EBVG EBCG

FLORAL		100 mm - 4"
Grate finish	Item No.	\$ / Unit
Brushed stainless steel (EB)	KDIF4 GRK EB D5	102.54
Brushed nickel (EBT)	KDIF4 GRK EBT D5	161.62
Brushed rose gold (EBRG)	KDIF4 GRK EBRG D5	161.62
Brushed vintage gold (EBVG)	KDIF4 GRK EBVG D5	161.62
Brushed classic gold (EBCG)	KDIF4 GRK EBCG D5	161.62

Contents	
	1x Grate and frame
	1x Height adjustment collar
	1x Lateral adjustment ring



GRATES FOR USE WITH FLANGES WITH 2" (50 MM) OUTLET

Schluter®-KERDI-DRAIN-STYLE - TRENDLINE

Stainless Steel

PURE		100 mm - 4"
Grate finish	Item No.	\$ / Unit
Matte white (MBW)	KDIF4 GRK MBW D8	161.62
▲ Ivory (TSI)	KDIF4 GRK TSI D8	161.62
Greige (TSBG)	KDIF4 GRK TSBG D8	161.62
Cream (TSC)	KDIF4 GRK TSC D8	161.62
Bronze (TSOB)	KDIF4 GRK TSOB D8	161.62
Stone grey (TSSG)	KDIF4 GRK TSSG D8	161.62
▲ Pewter (TSG)	KDIF4 GRK TSG D8	161.62
▲ Dark anthracite (TSDA)	KDIF4 GRK TSDA D8	161.62
Matte black (MGS)	KDIF4 GRK MGS D8	161.62

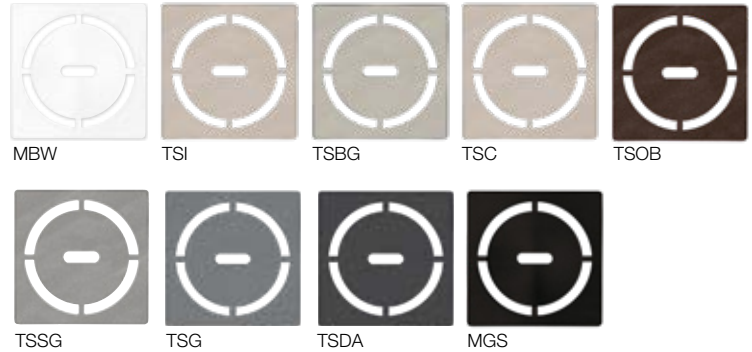

CURVE		100 mm - 4"
Grate finish	Item No.	\$ / Unit
Matte white (MBW)	KDIF4 GRK MBW D6	161.62
▲ Ivory (TSI)	KDIF4 GRK TSI D6	161.62
Greige (TSBG)	KDIF4 GRK TSBG D6	161.62
Cream (TSC)	KDIF4 GRK TSC D6	161.62
Bronze (TSOB)	KDIF4 GRK TSOB D6	161.62
Stone grey (TSSG)	KDIF4 GRK TSSG D6	161.62
▲ Pewter (TSG)	KDIF4 GRK TSG D6	161.62
▲ Dark anthracite (TSDA)	KDIF4 GRK TSDA D6	161.62
Matte black (MGS)	KDIF4 GRK MGS D6	161.62

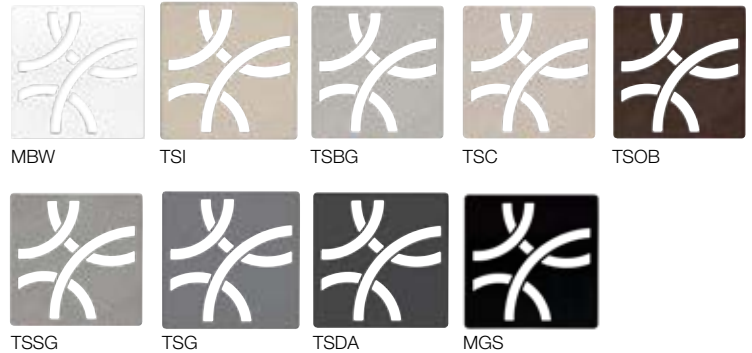

FLORAL		100 mm - 4"
Grate finish	Item No.	\$ / Unit
Matte white (MBW)	KDIF4 GRK MBW D5	161.62
▲ Ivory (TSI)	KDIF4 GRK TSI D5	161.62
Greige (TSBG)	KDIF4 GRK TSBG D5	161.62
Cream (TSC)	KDIF4 GRK TSC D5	161.62
Bronze (TSOB)	KDIF4 GRK TSOB D5	161.62
Stone grey (TSSG)	KDIF4 GRK TSSG D5	161.62
▲ Pewter (TSG)	KDIF4 GRK TSG D5	161.62
▲ Dark anthracite (TSDA)	KDIF4 GRK TSDA D5	161.62
Matte black (MGS)	KDIF4 GRK MGS D5	161.62

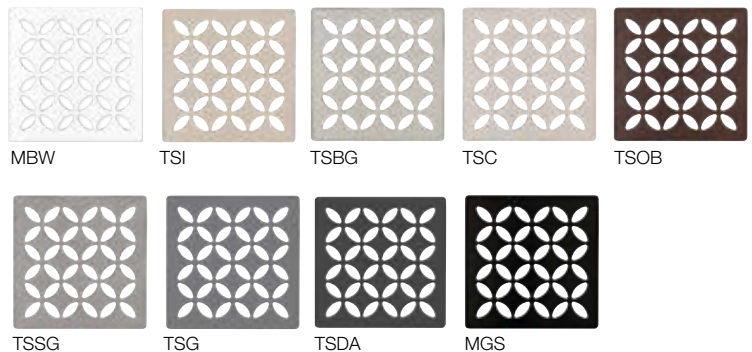

Contents



1x
Grate and frame



1x
Height adjustment collar



1x
Lateral adjustment ring



GRATES FOR USE WITH FLANGES WITH 2" (50 MM) OUTLET

Schluter®-KERDI-DRAIN

Stainless Steel

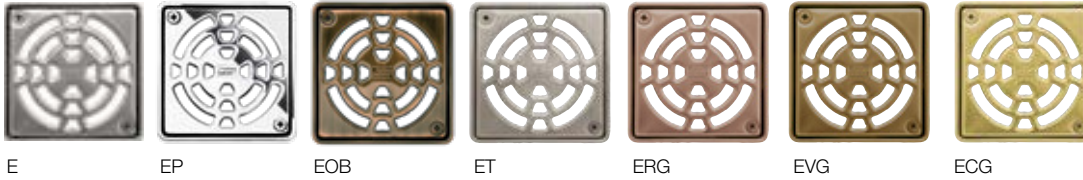



CLASSIC		100 mm - 4"		
Grate finish	1 UNIT		10-PACKS*	
	Item No.	\$ / Unit	Item No.	\$ / 10-Pack
Stainless steel (E)	KD4 GRK E	62.86	KD4 GRK E 10	565.69
Chrome (EP)	KD4 GRK EP	62.86	-	-
Oil-rubbed bronze (EOB)	KD4 GRK EOB	88.18	-	-
Nickel (ET)	KD4 GRK ET	101.76	-	-
Rose gold (ERG)	KD4 GRK ERG	101.76	-	-
Vintage gold (EVG)	KD4 GRK EVG	101.76	-	-
Classic gold (ECG)	KD4 GRK ECG	101.76	-	-

*Note: 10-packs are packaged in bulk, not individually boxed.

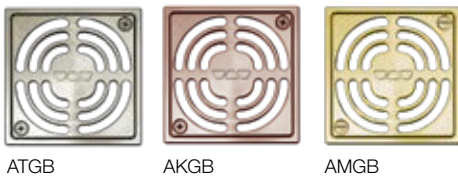
Anodized Aluminum



CONTOUR		100 mm - 4"	
Grate finish	Item No.	\$ / Unit	
Brushed nickel (ATGB)	KD4 GRK ATGB	88.18	
Brushed copper (AKGB)	KD4 GRK AKGB	88.18	
Brushed brass (AMGB)	KD4 GRK AMGB	88.18	

Contents	
	1x Grate and frame
	1x Height adjustment collar
	1x Lateral adjustment ring

Tileable Grate



TILE		100 mm - 4"	
Grate finish	Item No.	\$ / Unit	
TILE	KD4 GRK ECS	62.86	

Contents	
	1x Tileable covering support
	1x Spacer
	1x Lateral adjustment ring



The tileable grate is not suitable for use with the KERDI-DRAIN-F flange and the KERDI-DRAIN-A flange with 5-1/4" (133.4 mm) adaptor ring.



GRATES FOR USE WITH FLANGES WITH 2" (50 MM) or 3" (75 MM) OUTLET



Schluter®-KERDI-DRAIN

Stainless Steel



CLASSIC SQUARE		150 mm - 6"
Grate finish	Item No.	\$ / Unit
Stainless steel (E)	KD6 GRK E	84.29

CLASSIC ROUND		150 mm - 6"
Grate finish	Item No.	\$ / Unit
Stainless steel (E)	KD6 GRK RE	84.29

Contents	
 <p>1x Grate and frame with integrated height adjustment collar</p>	 <p>1x Lateral adjustment ring</p>



The 6" (150 mm) grates are not suitable for use with the KERDI-DRAIN-F flange and the KERDI-DRAIN-A flange with 5-1/4" (133.4 mm) adaptor ring.





Schluter®-KERDI-DRAIN PURE grate in greige (page 133)





FLANGE KITS WITH SEALS AND CORNERS



Schluter®-KERDI-DRAIN

Schluter®-KERDI-DRAIN - Flanges with vertical outlet					
					
		ABS	PVC	Stainless steel	
Material	Outlet	1 UNIT		10-PACKS*	
		Item No.	\$ / Unit	Item No.	\$ / 10-Pack
ABS	50 mm - 2"	KD2 FLK ABS	88.95	KD2 FLK ABS 10	800.58
ABS	75 mm - 3"	KD3 FLK ABS	100.55	-	-
PVC	50 mm - 2"	KD2 FLK PVC	88.95	KD2 FLK PVC 10	800.58
PVC	75 mm - 3"	KD3 FLK PVC	100.55	-	-
Stainless Steel	50 mm - 2" no-hub	KD2 FLK E	255.32	-	-
Stainless Steel	50 mm - 2" threaded	KD2 FLK ETH	284.08	-	-
Stainless Steel	75 mm - 3" no-hub	KD3 FLK E	255.32	-	-

*Note: 10-packs are packaged in bulk, not individually boxed.

Schluter®-KERDI-DRAIN-H

Schluter®-KERDI-DRAIN-H - Flanges with horizontal outlet			
			
		ABS	PVC
Material	Outlet	1 UNIT	
		Item No.	\$ / Unit
ABS	50 mm - 2"	KDH2 FLK ABS	88.95
PVC	50 mm - 2"	KDH2 FLK PVC	88.95

Additional components included with all flanges			
	4x Inside corners		2x Outside corners
	1x Pipe seal (20 mm - 3/4")		1x Mixing valve seal (114 mm - 4-1/2")

Also included with stainless steel flanges	
	1x KERDI-FIX sealing and bonding compound (100 ml - 3.38 fl oz) ⚠ WARNING: Reproductive Harm www.P65Warnings.ca.gov

i
When using a flange with 3" (75 mm) outlet, a 6" (150 mm) grate is recommended.



FLANGE MEASUREMENTS

Schluter®-KERDI-DRAIN

ABS or PVC

		50 mm - 2" drain outlet	75 mm - 3" drain outlet
	A	300 mm - 11-13/16"	300 mm - 11-13/16"
	B	115.2 mm - 4-17/32"	115.2 mm - 4-17/32"
	C	68.6 mm - 2-45/64"	100 mm - 3-15/16"
	D	60.5 mm - 2-3/8"	88.8 mm - 3-1/2"
	E	100 mm - 3-15/16"	100 mm - 3-15/16"
	F	40.6 mm - 1-39/64"	50.8 mm - 2"
	G	22.5 mm - 7/8"	38.1 mm - 1-1/2"

Stainless steel

		50 mm - 2" no-hub outlet	75 mm - 3" no-hub outlet
	A	250 mm - 9-27/32"	250 mm - 9-27/32"
	B	115.4 mm - 4-1/2"	114 mm - 4-1/2"
	C	61.3 mm - 2-13/32"	87.4 mm - 3-7/16"
	D	60.6 mm - 2-13/32"	84.2 mm - 3-5/16"
	E	85 mm - 3-11/32"	87.4 mm - 3-7/16"
	F	21 mm - 53/64"	29.4 mm - 1-5/32"

Schluter®-KERDI-DRAIN-H

ABS or PVC

		50 mm - 2" horizontal drain outlet
	A	300 mm - 11-13/16"
	B	118.3 mm - 4-21/32"
	C	69.5 mm - 2-47/64"
	D	60.5 mm - 2-3/8"
	E	85.7 mm - 3-3/8"
	F	27 mm - 1-1/16"

Schluter®-KERDI-SHOWER-CB

Schluter®-KERDI-SHOWER-CB is a height compensation board made of lightweight expanded polystyrene used to accommodate the drain body and waste pipe height, when installing the Schluter®-KERDI-DRAIN-H in conjunction with the Schluter®-KERDI-SHOWER-T/TS/TT shower trays. The compensation board can easily be cut to size to fit around the drain and waste pipe, and multiple boards can be used to fit the size and shape of the shower.

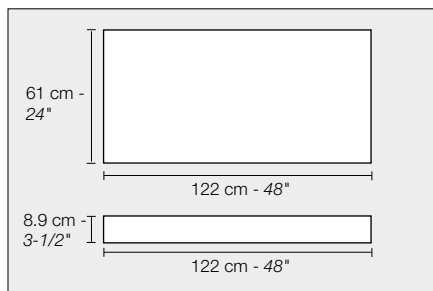

Schluter®-KERDI-SHOWER-CB		
Compensation board		
Item No.	Dimensions	\$ / Unit
KSCB 90 610 1220	122 cm x 61 cm x 8.9 cm - 48" x 24" x 3-1/2"	107.16

ADAPTOR KITS — 5-1/4" or 7-1/2" (133.4 or 191 mm)

Schluter®-KERDI-DRAIN-A

Schluter®-KERDI-DRAIN-A ADAPTOR KITS are used to convert traditional clamping ring drains to integrated bonding flange drains when removal of the clamping ring drain is not practical. A stainless steel adaptor ring with an overmolded rubber gasket replaces the clamping ring and is sealed to the existing drain body using Schluter®-KERDI-FIX. The bonding flange then slides into the adaptor ring and seals against the rubber gasket. Adaptor kits are suitable for both mortar bed and Schluter®-KERDI-SHOWER-T/-TS/-TT shower tray applications.

133.4 mm - 5-1/4" adaptor kit		
Flange and ring	1 UNIT	
	Item No.	\$ / Unit
<p>133.4 mm 5-1/4"</p> <p>Also included: Height adjustment collar for KERDI-DRAIN grate</p>	KDA5 FLK ABS	88.95
	10-PACK*	
	Item No.	\$ / 10-Pack
	KDA5 FLK ABS 10	800.58

191 mm - 7-1/2" adaptor kit		
Flange and ring	1 UNIT	
	Item No.	\$ / Unit
<p>191 mm 7-1/2"</p> <p>Also included: Lateral adjustment ring for KERDI-DRAIN grate</p>	KDA7 FLK ABS	121.99
	Item No.	\$ / 10-Pack
	KDA7 FLK ABS 10	1219.90

*Note: 10-packs are packaged in bulk, not individually boxed.

Additional components included

	4x Inside corners		2x Outside corners		1x Pipe seal (20 mm - 3/4")		1x Mixing valve seal (114 mm - 4-1/2")		1x KERDI-FIX sealing and bonding compound (100 ml - 3.38 fl oz)
--	-----------------------------	--	------------------------------	--	--	--	---	--	---

WARNING:
Reproductive Harm
www.P65Warnings.ca.gov

Flange and adaptor ring measurements	
	133.4 mm - 5-1/4"
	A 300 mm - 11-13/16"
	B 60.7 mm - 2-13/32"
	C 69.3 mm - 2-23/32"
	D 133.4 mm - 5-1/4"
	E 74 mm - 2-29/32"
	F 25.9 mm - 1-1/64"
	G 52.6 mm - 2-1/16"

Flange and adaptor ring measurements	
	191 mm - 7-1/2"
	A 300 mm - 11-13/16"
	B 111.8 mm - 4-13/32"
	C 118.9 mm - 4-11/16"
	D 191 mm - 7-1/2"
	E 130 mm - 5-7/64"
	F 77.8 mm - 3-1/16"
	G 92.4 mm - 3-41/64"



The tileable grate and the 6" (150 mm) round/square grates are not compatible with the flange with 5-1/4" (133.4 mm) adaptor ring.



FLANGE KITS WITHOUT SEALS AND CORNERS

Schluter®-KERDI-DRAIN

Schluter®-KERDI-DRAIN - Flanges with vertical outlet



ABS



PVC



Stainless steel

Material	Outlet	1 UNIT		10-PACKS*	
		Item No.	\$ / Unit	Item No.	\$ / 10-Pack
ABS	50 mm - 2"	KD2/ABS/FL	30.98	KD2/ABS/FL10	278.74
ABS	75 mm - 3"	KD3/ABS/FL	42.58	-	-
PVC	50 mm - 2"	KD2/PVC/FL	30.98	KD2/PVC/FL10	278.74
PVC	75 mm - 3"	KD3/PVC/FL	42.58	-	-
Stainless Steel	50 mm - 2" no-hub	KD2/E/FL	209.77	KD2/E/FL10	1,713.61
Stainless Steel	50 mm - 2" threaded	KD2/ETH/FL	213.68	-	-
Stainless Steel	75 mm - 3" no-hub	KD3/E/FL	209.77	-	-

***Notes:**

- 10-packs are packaged in bulk, not individually boxed.
- The stainless steel flange 10-pack does not include KERDI-FIX.

Also included with stainless steel flanges



1x

KERDI-FIX
sealing and bonding compound (100 ml - 3.38 fl oz)
(not included with 10-pack)

⚠ WARNING: Reproductive Harm
www.P65Warnings.ca.gov



When using a flange with 3" (75 mm) outlet,
a 6" (150 mm) grate is recommended.

Schluter®-KERDI-DRAIN-H

Schluter®-KERDI-DRAIN-H - Flanges with horizontal outlet



ABS



PVC









Material	Outlet	Item No.	\$ / Unit
ABS	50 mm - 2"	KDH2/ABS/FL	30.98
PVC	50 mm - 2"	KDH2/PVC/FL	30.98



COMPLETE DRAIN KITS









Schluter®-KERDI-DRAIN

Schluter®-KERDI-DRAIN Kit					
Flange		Grate - 100 mm - 4"		Item No.	\$ / Unit
Material	Outlet	Grate Design	Grate Finish		
ABS	50 mm - 2"	CLASSIC	Stainless steel (E)	KD2/ABS/E	151.80
PVC	50 mm - 2"	CLASSIC	Stainless steel (E)	KD2/PVC/E	151.80

Contents							
	1x Flange		1x Grate and frame		1x Height adjustment collar		1x Lateral adjustment ring
	4x Inside corners		2x Outside corners		1x Pipe seal (20 mm - 3/4")		1x Mixing valve seal (114 mm - 4-1/2")

Schluter®-KERDI-DRAIN-A

Schluter®-KERDI-DRAIN-A Adaptor Kit – 133.4 mm - 5-1/4"				
Adaptor	Grate - 100 mm - 4"		Item No.	\$ / Unit
Ring Size	Grate Design	Grate Finish		
133.4 mm - 5-1/4"	CLASSIC	Stainless steel (E)	KDAR/ABS/E	151.80

Contents							
	1x Flange		1x Grate and frame		1x Height adjustment collar		1x Adaptor ring
	4x Inside corners		2x Outside corners		1x Pipe seal (20 mm - 3/4")		1x Mixing valve seal (114 mm - 4-1/2")
	1x KERDI-FIX sealing and bonding compound (100 ml - 3.38 fl oz)	⚠ WARNING: Reproductive Harm – www.P65Warnings.ca.gov					



FLOOR DRAIN WITH INTEGRATED KERDI COLLAR

Schluter®-KERDI-DRAIN-F

Schluter®-KERDI-DRAIN-F is a floor drain specifically designed to allow connections to Schluter®-DITRA and DITRA-HEAT uncoupling membranes in floor applications. The drain body is available in polypropylene or stainless steel, each with a laminated Schluter®-KERDI collar that ensures a simple connection to the uncoupling membrane on the floor and at wall transitions. KERDI-DRAIN-F features a flat, narrow bonding flange to allow for placement against walls or in corners. It can be combined with virtually any KERDI-DRAIN grate assembly, with the exception of the tileable grate and the 6" (150 mm) square and round grates. The grate assembly is sold separately, please refer to pages 132 - 134.

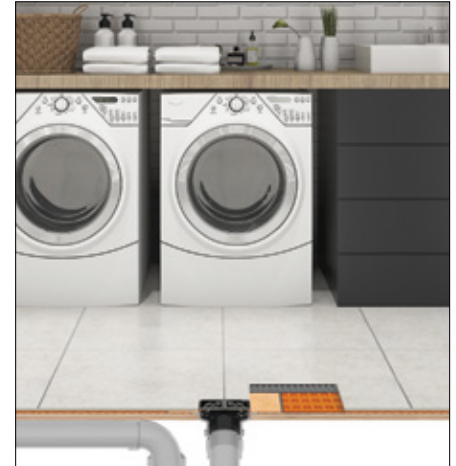



Schluter®-KERDI-DRAIN-F - Floor drain with narrow bonding flange and integrated KERDI collar

Polypropylene	Stainless steel with no-hub outlet	Stainless steel with threaded outlet
		
ABS and PVC couplings included 		

Material	Outlet	Item No.	\$ / Unit
Polypropylene	50 mm - 2" NPT	KDF2FL	54.08
Stainless Steel	50 mm - 2" no-hub	KDF2EFL	245.87
Stainless Steel	50 mm - 2" threaded	KDF2ETHFL	273.64

Listed by ICC-ES (Report No. PMG-1204), UPC® and CSA.

Additional components included

 1x Vertical height adjustment collar	 1x Construction cover
--	---

i The tileable grate and the 6" (150 mm) round/square grates are not compatible with KERDI-DRAIN-F.

Drain measurements

Polypropylene 50 mm (2") outlet		Stainless steel 50 mm (2") no-hub outlet		Stainless steel 50 mm (2") threaded outlet	
A	268 mm - 10-9/16"	A	280 mm - 11-1/32"	A	280 mm - 11-1/32"
B	128 mm - 5-1/32"	B	139 mm - 5-15/32"	B	139 mm - 5-15/32"
C	101.1 mm - 3-31/32"	C	98 mm - 3-27/32"	C	98 mm - 3-27/32"
D	75.4 mm - 2-31/32"	D	77.2 mm - 3-1/32"	D	73.7 mm - 2-29/32"
E	3 mm - 1/8"	E	1.5 mm - 1/16"	E	1.5 mm - 1/16"



Schluter®-KERDI-DRAIN

6" SQUARE CLEAN OUT COVER

The **Schluter®-KERDI-DRAIN Clean Out Cover** is a 6" (150 mm) stainless steel cover available for installations where the KERDI-DRAIN bonding flange is to be used in a cleanout application. The KERDI-DRAIN bonding flange is sold separately.



Clean out cover 150 mm - 6"		
Item No.	Finish	\$ / Unit
KD-GR6C-E	Stainless steel	170.40

TAMPER PROOF SCREWS

Schluter®-KERDI-DRAIN Tamper Proof Screws are designed as a high security accessory for the KERDI-DRAIN. Ideal for loss prevention and anti-theft, these tamper proof screws are used in environments where tamper resistance is desired or required (e.g., healthcare or education facilities, etc.). Phillips head screws are included with the KERDI-DRAIN. The tamper-proof screws as well as the driver bit must be purchased separately.



Tamper proof screw and driver bit		
Item No.	Description	\$ / Unit
KD/TPSCRW	Tamper proof screw (1)	2.96
KD/TPWRCH	Driver bit (1)	14.44

STRAINER

The **Schluter®-KERDI-DRAIN Strainer** is a hair catcher customized to fit inside the KERDI-DRAIN flange to trap and collect hair. Simple to remove and clean, the hair catcher fits discreetly into the drain to prevent hair clogs that can lead to blocked pipes.

Note: The KERDI-DRAIN strainer is only suitable for use with flanges with 2" (50 mm) vertical outlets (ABS, PVC, and stainless steel with no-hub or threaded outlet).



Strainer for KERDI-DRAIN		
Item No.	Description	\$ / Unit
KD-STR	Strainer	3.29



Schluter® Linear Drains

Discover the benefits of Schluter® linear drains for an enhanced shower experience. Upgrade your tiled shower with the KERDI-LINE low-profile drain, ideal for curbless bathrooms. With various grate designs, including a tileable option, it's suitable for wall or intermediate locations in showers, steam rooms, and wet rooms. For a customizable solution, consider the KERDI-LINE-VARIO, which can be cut on-site for specific project needs. It comes in 4-foot and 8-foot lengths with four slim and modern grate designs.

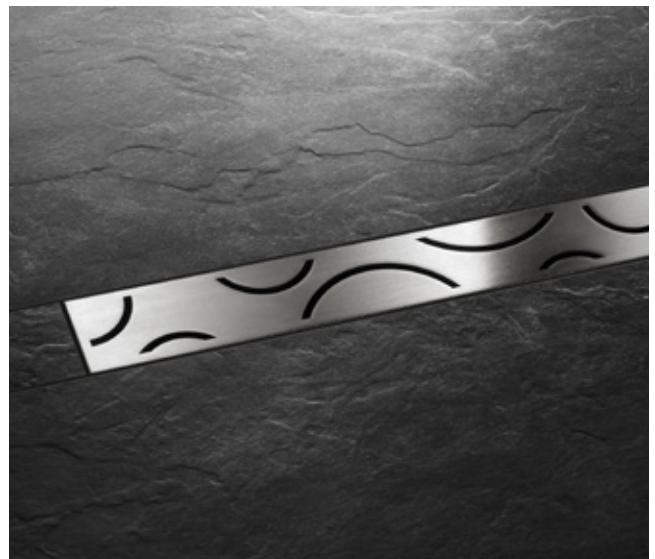
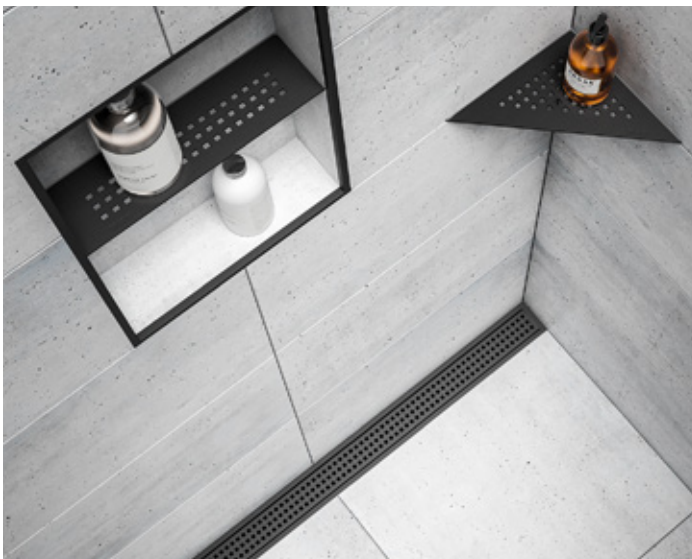

Schluter®-KERDI-LINE

The **Schluter®-KERDI-LINE** is a low profile linear floor drain specifically designed for bonded waterproofing assemblies. KERDI-LINE can be installed adjacent to walls or at intermediate locations in showers, wet rooms, and other applications that require waterproofing and drainage. The floor can be sloped on a single plane to KERDI-LINE, which enables the use of large-format tiles and creates interesting design opportunities.

The KERDI-LINE channel body is made of formed stainless steel 316L (1.4404 = V4A) and features a collar made of Schluter®-KERDI for a secure waterproof connection. The grate assembly is available in six design options:

- A - SOLID
- B - SQUARE
- D - TILE
- E - FLORAL
- F - CURVE
- G - PURE

If KERDI-LINE is placed at shower entrance, it is recommended that grate assembly A (SOLID), G (PURE), or D (TILE) is chosen and that the drainage openings span the maximum width of the shower entrance to limit potential overflow; secondary drainage (e.g., KERDI-DRAIN) may be required in the drying area.

Grate and frame assemblies A and B are available in brushed stainless steel, or stainless steel with chrome finish, and can be adjusted for use with tile coverings from 1/8" to 1" (3 mm to 25 mm)-thick. The TILE grate (D) is frameless and can accommodate any thickness of tile covering. Grate and frame assemblies E, F and G (KERDI-LINE-STYLE) are available in brushed stainless steel and can accommodate tile coverings from 1/4" to 11/16" (6 - 18 mm)-thick.

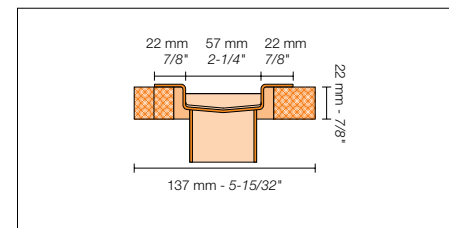
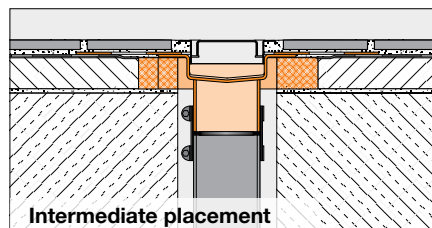
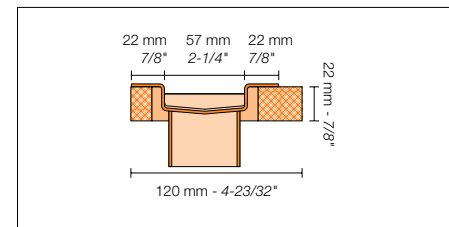
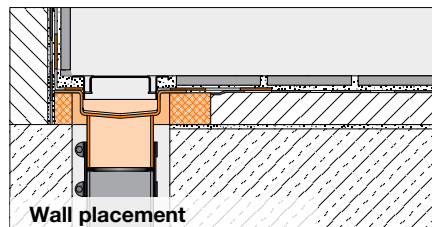
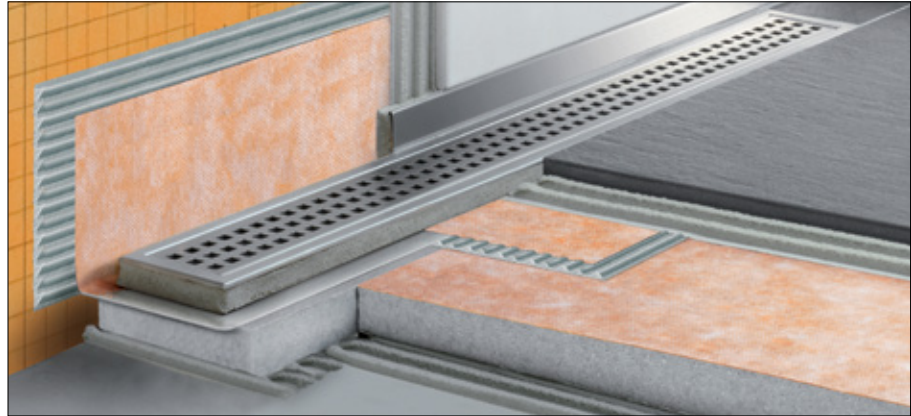

Selecting your Schluter®-KERDI-LINE

Schluter®-KERDI-LINE channel bodies and grates are sold separately.

- 1 Select the appropriate channel body length and outlet placement from the tables on page 145.
- 2 Proceed to grate selection accordingly from pages 146 - 149, keeping in mind there are two frame height options for the SQUARE and SOLID grates.

i

All configurations of KERDI-LINE are listed by ICC-ES (Report No. PMG-1204), UPC®, and CSA. For copies of these documents, please contact Schluter®-Systems at 800-472-4588 or by email at info@schluter.com. Links to the documents can also be accessed at Schluter.com.



Schluter®-KERDI-LINE

CHANNEL BODY

Contents

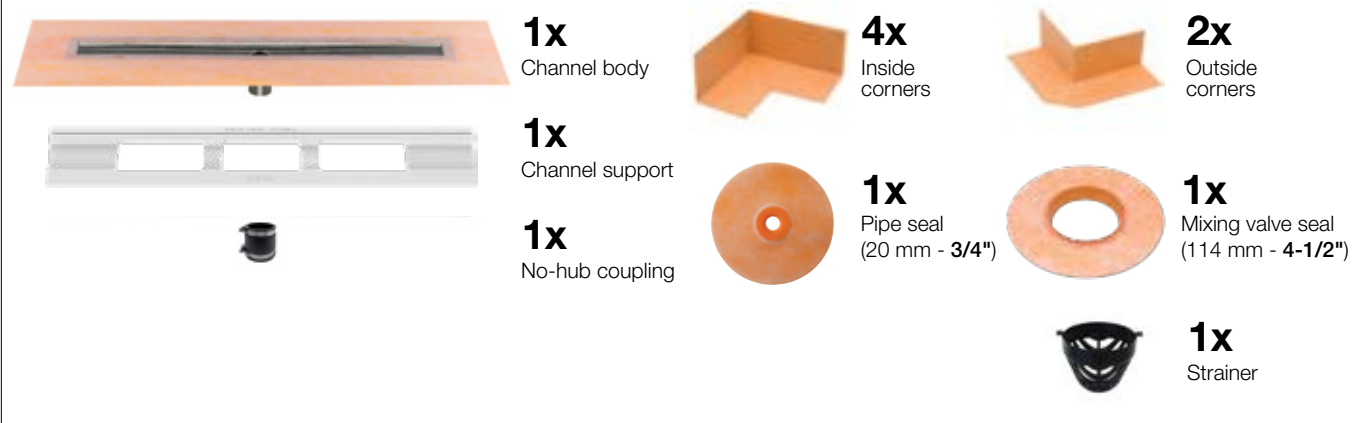

Channel body center outlet

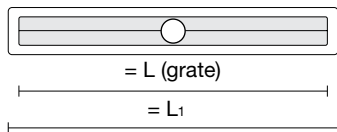

Channel body off-set outlet

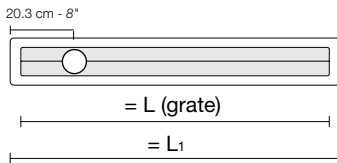

Schluter®-KERDI-LINE

Channel body - stainless steel - center outlet

L ₁ = cm - in.	L (grate) = cm - in.	Item No.	\$ / Unit
55 - 21-11/16	50 - 19-11/16	KL1V 60 E 50	360.36
65 - 25-5/8	60 - 23-5/8	KL1V 60 E 60	371.80
75 - 29-9/16	70 - 27-9/16	KL1V 60 E 70	403.85
85 - 33-1/2	80 - 31-1/2	KL1V 60 E 80	407.75
95 - 37-7/16	90 - 35-7/16	KL1V 60 E 90	425.85
105 - 41-3/8	100 - 39-3/8	KL1V 60 E 100	437.74
115 - 45-5/16	110 - 43-5/16	KL1V 60 E 110	446.87
125 - 49-1/4	120 - 47-1/4	KL1V 60 E 120	467.69
135 - 53-3/16	130 - 51-3/16	KL1V 60 E 130	566.74
145 - 57-1/8	140 - 55-1/8	KL1V 60 E 140	581.13
155 - 61-1/16	150 - 59-1/16	KL1V 60 E 150	595.03
165 - 64-15/16	160 - 62-15/16	KL1V 60 E 160	606.57
175 - 68-7/8	170 - 66-7/8	KL1V 60 E 170	616.05
185 - 72-13/16	180 - 70-13/16	KL1V 60 E 180	626.71

Channel body - stainless steel - off-set outlet

L ₁ = cm - in.	L (grate) = cm - in.	Item No.	\$ / Unit
75 - 29-9/16	70 - 27-9/16	KL1VO 60 E 70	408.81
85 - 33-1/2	80 - 31-1/2	KL1VO 60 E 80	412.78
95 - 37-7/16	90 - 35-7/16	KL1VO 60 E 90	431.67
105 - 41-3/8	100 - 39-3/8	KL1VO 60 E 100	459.52
115 - 45-5/16	110 - 43-5/16	KL1VO 60 E 110	478.14
125 - 49-1/4	120 - 47-1/4	KL1VO 60 E 120	500.85



Schluter®-KERDI-LINE

GRATE ASSEMBLY - BRUSHED STAINLESS STEEL

CONTENTS

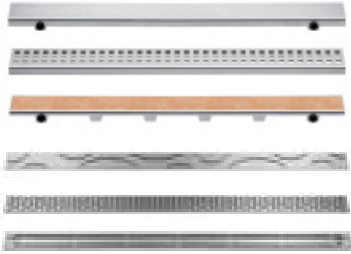

1x
Grate
6 design options:

- SOLID
- SQUARE
- TILE
- CURVE
- FLORAL
- PURE



1x
Grate frame with height adjustment spacers. See product tables for frame height options (not included with TILE grate).



1x
Grate removal tool



SOLID (A)



SQUARE (B)

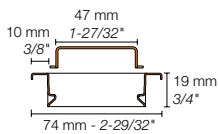

19 mm - 3/4" Frame

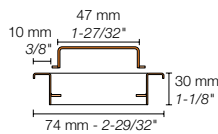

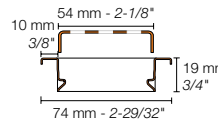

30 mm - 1-1/8" Frame

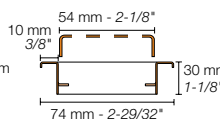

19 mm - 3/4" Frame



30 mm - 1-1/8" Frame

Grate assemblies - Brushed stainless steel					
 19 mm - 3/4" frame height for 3 mm to 15 mm - 1/8" to 9/16" -thick coverings					
Length = cm - in.	SOLID (A)		SQUARE (B)		
	Item No.	\$ / Unit	Item No.	\$ / Unit	
50 - 19-11/16	KL1AR 19 EB 50	335.01	KL1B 19 EB 50	304.87	
60 - 23-5/8	KL1AR 19 EB 60	344.62	KL1B 19 EB 60	310.69	
70 - 27-9/16	KL1AR 19 EB 70	358.77	KL1B 19 EB 70	327.87	
80 - 31-1/2	KL1AR 19 EB 80	368.05	KL1B 19 EB 80	333.82	
90 - 35-7/16	KL1AR 19 EB 90	385.35	KL1B 19 EB 90	352.00	
100 - 39-3/8	KL1AR 19 EB 100	408.40	KL1B 19 EB 100	362.17	
110 - 43-5/16	KL1AR 19 EB 110	418.44	KL1B 19 EB 110	375.13	
120 - 47-1/4	KL1AR 19 EB 120	426.00	KL1B 19 EB 120	382.25	
130 - 51-3/16	KL1AR 19 EB 130	555.42	KL1B 19 EB 130	555.42	
140 - 55-1/8	KL1AR 19 EB 140	583.26	KL1B 19 EB 140	583.26	
150 - 59-1/16	KL1AR 19 EB 150	613.82	KL1B 19 EB 150	613.82	
160 - 62-15/16	KL1AR 19 EB 160	653.52	KL1B 19 EB 160	653.52	
170 - 66-7/8	KL1AR 19 EB 170	681.33	KL1B 19 EB 170	681.33	
180 - 70-13/16	KL1AR 19 EB 180	720.37	KL1B 19 EB 180	720.37	
 30 mm - 1-1/8" frame height for 13 mm to 25 mm - 1/2" to 1" -thick coverings					
50 - 19-11/16	KL1AR 30 EB 50	344.67	KL1B 30 EB 50	313.65	
60 - 23-5/8	KL1AR 30 EB 60	356.43	KL1B 30 EB 60	321.35	
70 - 27-9/16	KL1AR 30 EB 70	372.72	KL1B 30 EB 70	340.59	
80 - 31-1/2	KL1AR 30 EB 80	383.39	KL1B 30 EB 80	347.70	
90 - 35-7/16	KL1AR 30 EB 90	403.96	KL1B 30 EB 90	369.01	
100 - 39-3/8	KL1AR 30 EB 100	429.09	KL1B 30 EB 100	380.50	
110 - 43-5/16	KL1AR 30 EB 110	440.41	KL1B 30 EB 110	394.82	
120 - 47-1/4	KL1AR 30 EB 120	447.97	KL1B 30 EB 120	401.93	



Schluter®-KERDI-LINE

GRATE ASSEMBLY - CHROME

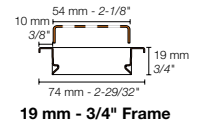
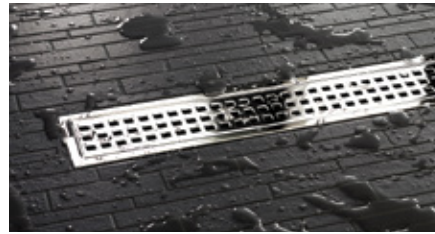
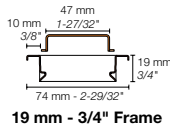
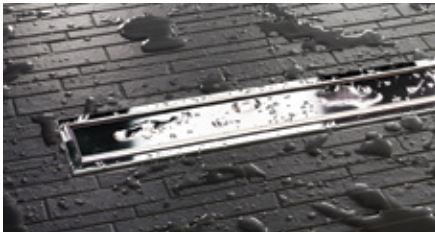

SOLID (A)

SQUARE (B)

Grate assemblies - Chrome



19 mm - 3/4" frame height for
3 mm to 15 mm - 1/8" to 9/16" -thick coverings

Length = cm - in.	SOLID (A)		SQUARE (B)	
	Item No.	\$ / Unit	Item No.	\$ / Unit
50 - 19-11/16	KL1AR 19 EP 50	368.52	KL1B 19 EP 50	335.36
60 - 23-5/8	KL1AR 19 EP 60	379.08	KL1B 19 EP 60	341.77
70 - 27-9/16	KL1AR 19 EP 70	394.64	KL1B 19 EP 70	360.66
80 - 31-1/2	KL1AR 19 EP 80	404.84	KL1B 19 EP 80	367.20
90 - 35-7/16	KL1AR 19 EP 90	423.88	KL1B 19 EP 90	387.19
100 - 39-3/8	KL1AR 19 EP 100	449.25	KL1B 19 EP 100	398.38
110 - 43-5/16	KL1AR 19 EP 110	460.27	KL1B 19 EP 110	412.63
120 - 47-1/4	KL1AR 19 EP 120	468.61	KL1B 19 EP 120	420.48

GRATE ASSEMBLY - MATTE BLACK

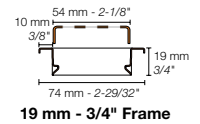
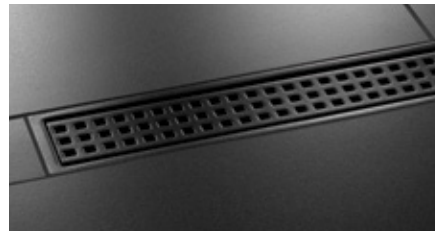
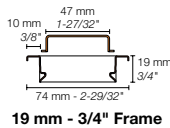
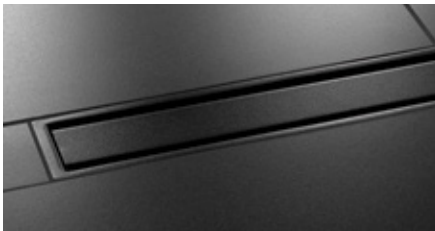

SOLID (A)

SQUARE (B)

Grate assemblies - Matte black



19 mm - 3/4" frame height for
3 mm to 15 mm - 1/8" to 9/16" -thick coverings

Length = cm - in.	SOLID (A)		SQUARE (B)	
	Item No.	\$ / Unit	Item No.	\$ / Unit
50 - 19-11/16	KL1AR 19 MGS 50	387.75	KL1B 19 MGS 50	352.86
60 - 23-5/8	KL1AR 19 MGS 60	398.86	KL1B 19 MGS 60	359.61
70 - 27-9/16	KL1AR 19 MGS 70	415.25	KL1B 19 MGS 70	379.48
80 - 31-1/2	KL1AR 19 MGS 80	425.98	KL1B 19 MGS 80	386.36
90 - 35-7/16	KL1AR 19 MGS 90	446.01	KL1B 19 MGS 90	407.41
100 - 39-3/8	KL1AR 19 MGS 100	472.69	KL1B 19 MGS 100	419.17
110 - 43-5/16	KL1AR 19 MGS 110	484.30	KL1B 19 MGS 110	434.17
120 - 47-1/4	KL1AR 19 MGS 120	493.07	KL1B 19 MGS 120	442.42
130 - 51-3/16	KL1AR 19 MGS 130	642.85	KL1B 19 MGS 130	642.85
140 - 55-1/8	KL1AR 19 MGS 140	675.07	KL1B 19 MGS 140	675.07
150 - 59-1/16	KL1AR 19 MGS 150	710.44	KL1B 19 MGS 150	710.44
160 - 62-15/16	KL1AR 19 MGS 160	756.39	KL1B 19 MGS 160	756.39
170 - 66-7/8	KL1AR 19 MGS 170	788.58	KL1B 19 MGS 170	788.58
180 - 70-13/16	KL1AR 19 MGS 180	833.76	KL1B 19 MGS 180	833.76



GRATE ASSEMBLY - TILE



TILE (D)

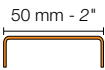

Grate assemblies - TILE			
Length = cm - in.	Item No.		\$ / Unit
	TILE (D)		
	For use with center outlet channel body	For use with off-set outlet channel body	
50 - 19-11/16	KL1DRE 50	-	155.12
60 - 23-5/8	KL1DRE 60	-	162.67
70 - 27-9/16	KL1DRE 70	KL1DRO E 70	170.19
80 - 31-1/2	KL1DRE 80	KL1DRO E 80	177.74
90 - 35-7/16	KL1DRE 90	KL1DRO E 90	190.57
100 - 39-3/8	KL1DRE 100	KL1DRO E 100	211.95
110 - 43-5/16	KL1DRE 110	KL1DRO E 110	219.43
120 - 47-1/4	KL1DRE 120	KL1DRO E 120	226.92
130 - 51-3/16	KL1DRE 130	-	273.63
140 - 55-1/8	KL1DRE 140	-	275.99
150 - 59-1/16	KL1DRE 150	-	278.81
160 - 62-15/16	KL1DRE 160	-	306.25
170 - 66-7/8	KL1DRE 170	-	309.27
180 - 70-13/16	KL1DRE 180	-	311.81

Schluter®-KERDI-LINE-STYLE

GRATE ASSEMBLY - BRUSHED STAINLESS STEEL STYLE DESIGNS



CURVE

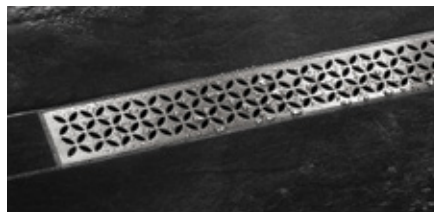
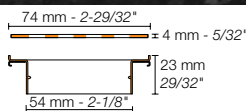

FLORAL

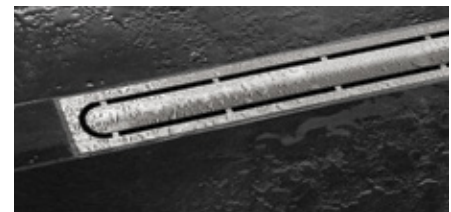
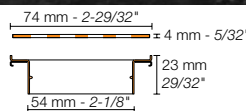

PURE

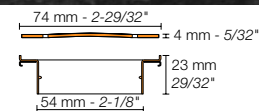

Grate assemblies - Brushed stainless steel						
23 mm - 29/32" frame height for 6 - 18 mm - 1/4" - 11/16" -thick coverings						
Length = cm - in.	CURVE		FLORAL		PURE	
	Item No.	\$ / Unit	Item No.	\$ / Unit	Item No.	\$ / Unit
50 - 19-11/16	KL11FF 23 EB 50	347.08	KL11FE 23 EB 50	360.69	KL11FG 23 EB 50	387.91
60 - 23-5/8	KL11FF 23 EB 60	360.69	KL11FE 23 EB 60	374.31	KL11FG 23 EB 60	401.52
70 - 27-9/16	KL11FF 23 EB 70	374.31	KL11FE 23 EB 70	387.91	KL11FG 23 EB 70	418.54
80 - 31-1/2	KL11FF 23 EB 80	394.73	KL11FE 23 EB 80	415.14	KL11FG 23 EB 80	435.54
90 - 35-7/16	KL11FF 23 EB 90	415.14	KL11FE 23 EB 90	442.34	KL11FG 23 EB 90	455.97
100 - 39-3/8	KL11FF 23 EB 100	435.54	KL11FE 23 EB 100	469.58	KL11FG 23 EB 100	476.39
110 - 43-5/16	KL11FF 23 EB 110	455.97	KL11FE 23 EB 110	496.80	KL11FG 23 EB 110	503.60
120 - 47-1/4	KL11FF 23 EB 120	476.39	KL11FE 23 EB 120	524.01	KL11FG 23 EB 120	530.81



Schluter®-KERDI-LINE

SQUARE GRATE WITH LOCKING MECHANISM

The Schluter®-KERDI-LINE SQUARE grate assembly (B) with 3/4" (19 mm) frame height is available with a locking mechanism for applications where tamper resistance is required.



SQUARE grate assembly with locking mechanism		
Length = cm - in.	Item No.	\$ / Unit
50 - 19-11/16	KL1BL 19 EB 50	337.37
60 - 23-5/8	KL1BL 19 EB 60	341.78
70 - 27-9/16	KL1BL 19 EB 70	358.36
80 - 31-1/2	KL1BL 19 EB 80	363.30
90 - 35-7/16	KL1BL 19 EB 90	382.65
100 - 39-3/8	KL1BL 19 EB 100	390.24
110 - 43-5/16	KL1BL 19 EB 110	403.35
120 - 47-1/4	KL1BL 19 EB 120	408.63
130 - 51-3/16	KL1BL 19 EB 130	598.92
140 - 55-1/8	KL1BL 19 EB 140	626.77
150 - 59-1/16	KL1BL 19 EB 150	657.31
160 - 62-15/16	KL1BL 19 EB 160	697.02
170 - 66-7/8	KL1BL 19 EB 170	724.84
180 - 70-13/16	KL1BL 19 EB 180	763.87

Note: Driver bit for tamper-proof screws sold separately. Please see page 142.

COVER PLATE

Schluter®-KERDI-LINE-FC

Schluter®-KERDI-LINE-FC is a stainless steel cover plate for use with the Schluter®-KERDI-LINE linear floor drain to create a seamless look in applications where multiple drains are installed end to end. KERDI-LINE-FC is designed for use with either the SOLID or SQUARE grates.

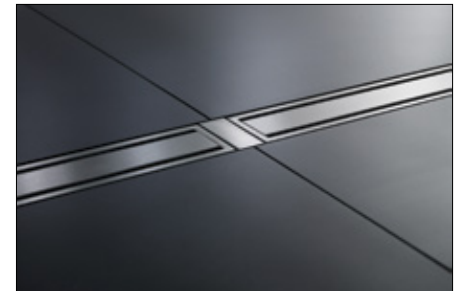
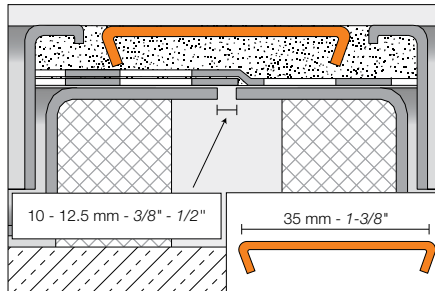

Schluter®-KERDI-LINE-FC Cover Plate					
Brushed stainless steel		Chrome		Matte black	
Item No.	\$ / Unit	Item No.	\$ / Unit	Item No.	\$ / Unit
V / KLEB 35	18.04	V / KLEP 35	18.04	V / KLMGS 35	20.88

STRAINER

The Schluter®-KERDI-LINE Strainer is a hair catcher customized to fit inside the KERDI-LINE channel body to trap and collect hair. Simple to remove and clean, the hair catcher fits discreetly into the drain to prevent hair clogs that can lead to blocked pipes.



Strainer for KERDI-LINE		
Item No.	Description	\$ / Unit
KL VZ SF	Strainer	3.29



NEW! Schluter®-KERDI-LINE-VARIO

Variable length linear drain

The next generation of linear drains is here: KERDI-LINE-VARIO is a variable length linear drain for tiled showers. The brushed stainless steel channel and grate assembly can be cut to size on-site, and are therefore customizable to fit various shower sizes.

▲ Schluter®-KERDI-LINE-VARIO

Schluter®-KERDI-LINE-VARIO is a low-profile, variable length linear shower drain specifically designed for bonded waterproofing assemblies. KERDI-LINE-VARIO can be initially cut to size on-site to fit the specific dimensions of the shower. The floor can be sloped on a single plane to KERDI-LINE-VARIO, which enables the use of large-format tiles and creates interesting design opportunities.

The KERDI-LINE-VARIO flange comprises an injection molded polypropylene drain body featuring a standard 2" (50 mm) NPT outlet and is supplied with PVC and ABS couplings. The perimeter consists of a bonding flange laminated with a collar made of KERDI for a simple and secure connection to the bonded waterproofing assembly, both in the floor area and on adjacent walls. KERDI-LINE-VARIO can be installed in conjunction with the KERDI-SHOWER-LT/-LTS shower trays or with a mortar bed.

The KERDI-LINE-VARIO channel and grate assembly is made of formed stainless steel 316L (1.4404 = V4A) and is designed to be trimmed to length to ensure a proper fit in custom applications. The channel features a drainage opening in the center. The flange outlet may be positioned anywhere within the overall trimmed length of the channel to avoid obstacles encountered during construction (e.g., floor joists). The grate nests into the corresponding channel. If the grate is trimmed, the supplied end caps are used to provide a clean finished look.

The KERDI-LINE-VARIO grate assembly features a minimal reveal after installation and is available in four designs:

- SQUARE
- FLORAL
- HERRINGBONE
- SLANT

The KERDI-LINE-VARIO flange kit and the grate and channel kit must be purchased separately.

Notes:

- The shortest allowable length to cut the channel and grate is 10" (25.4 cm).
- The minimum recommended tile thickness to use with the KERDI-LINE-VARIO channel is 3/8" (10 mm).
- KERDI-LINE-VARIO is best suited for placement against the wall but can also be installed in the center of the shower. For drain placement at the entrance of the shower, please refer to the KERDI-LINE linear drain.
- KERDI-LINE-VARIO drains are designed to meet the International Plumbing Code (IPC) guideline for a single standard showerhead with a maximum flow of 2.5 gpm (9.5 L/m). For showers with higher flow, the KERDI-LINE linear drain is recommended.

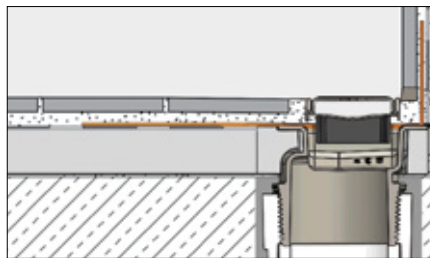











All configurations of KERDI-LINE-VARIO are listed by ICC-ES (Report No. PMG-1204) and UPC®. For copies of these documents, please contact Schluter®-Systems at 800-472-4588 or by email at info@schluter.com. Links to the documents can also be accessed at Schluter.com.



Schluter®-KERDI-LINE-VARIO

FLANGE KIT

Contents

	1x Flange		4x Inside corners		2x Outside corners
	1x Downspout		1x Pipe seal (20 mm - 3/4")		1x Mixing valve seal (114 mm - 4-1/2")
	1x Flange support		1x ABS coupling		1x Cleaning brush
	1x PVC coupling		1x Grate removal tool		1x Construction cover

KERDI-LINE-VARIO			
Flange Kit			
Material	Outlet	Item No.	\$ / Unit
Polypropylene	50 mm - 2" NPT	KL VR 2 FLK	123.00

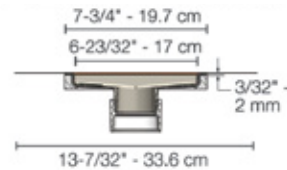

GRATE AND CHANNEL KIT

Contents

	1x Grate 4 options: • HERRINGBONE • SLANT • FLORAL • SQUARE		2x End caps
	1x Channel		



HERRINGBONE



SLANT



FLORAL



SQUARE

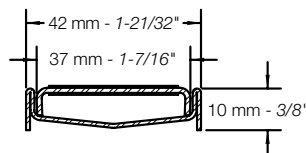

Grate and Channel Kit – Brushed stainless steel						
Length = cm - in.	HERRINGBONE	SLANT	FLORAL	\$ / Unit	SQUARE	\$ / Unit
	Item No.	Item No.	Item No.		Item No.	
122 - 48	KL VRI D13 EB 122	KL VRI D14 EB 122	KL VRI D5 EB 122	249.70	KL VRI D3 EB 122	262.00
244 - 96	KL VRI D13 EB 244	KL VRI D14 EB 244	KL VRI D5 EB 244	470.08	KL VRI D3 EB 244	479.01



Prefabricated Substrates

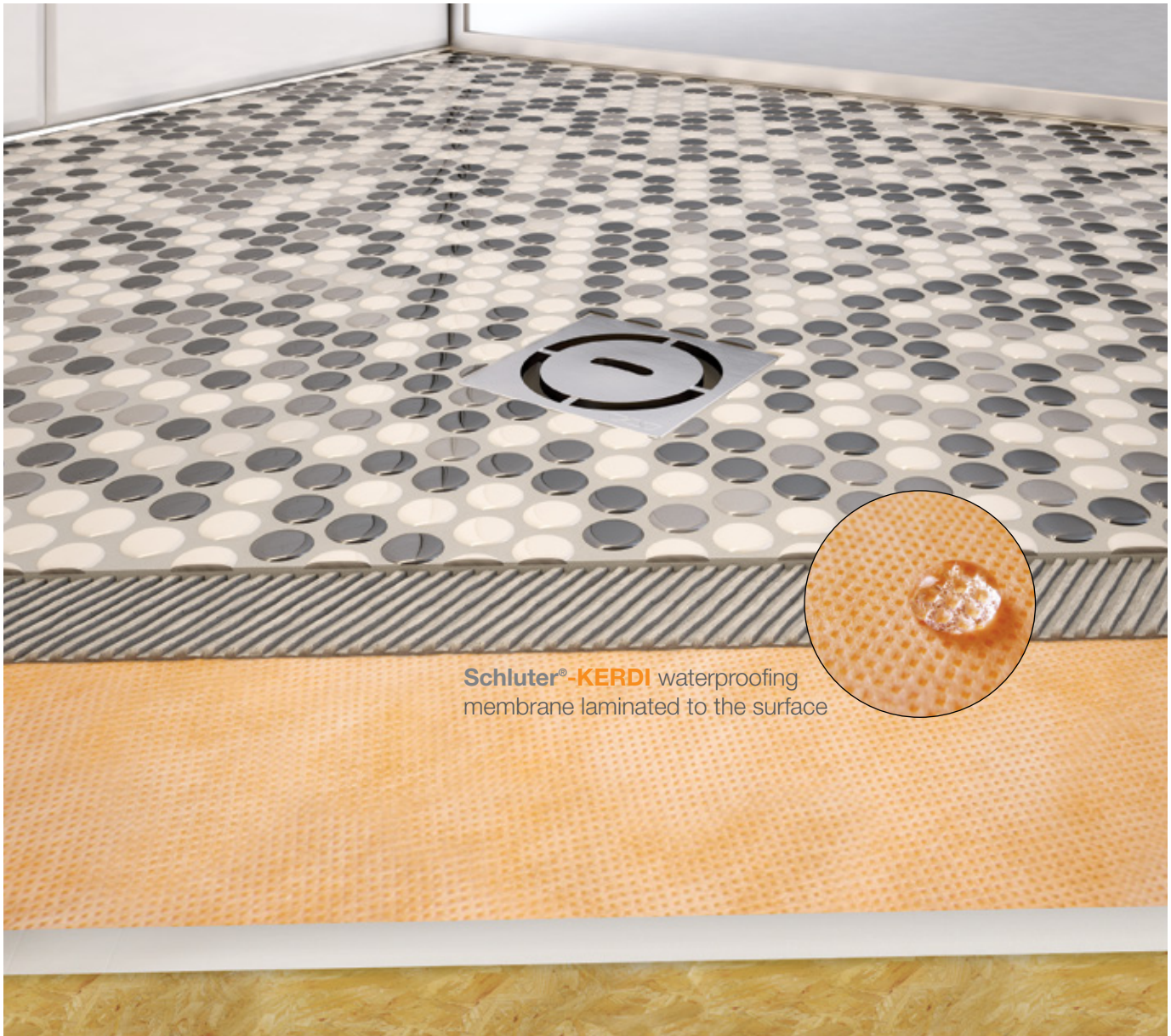

Prefabricated shower trays, curbs, ramps, benches, and niches integrate seamlessly with KERDI and KERDI-BOARD shower assemblies, and are ideal solutions for including mortar-free shower components in any tiled shower. Quick and easy to install, Schluter prefabricated substrates combine comfort, convenience, and design and are available in multiple sizes and shapes to fit any décor.





Schluter®-KERDI-SHOWER-T/-TS/-TT

Schluter®-KERDI-SHOWER-T/-TS/-TT are sloped shower trays with integrated KERDI waterproofing. The trays are made of lightweight, expanded polystyrene (PS 40) for constructing mortar-free shower bases. Each of these prefabricated shower trays is designed to integrate with the Schluter®-KERDI-DRAIN.

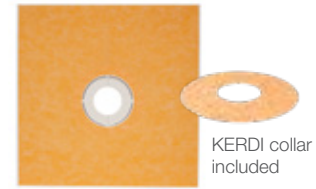

The **KERDI-SHOWER-T** is the standard tray with center drain placement.

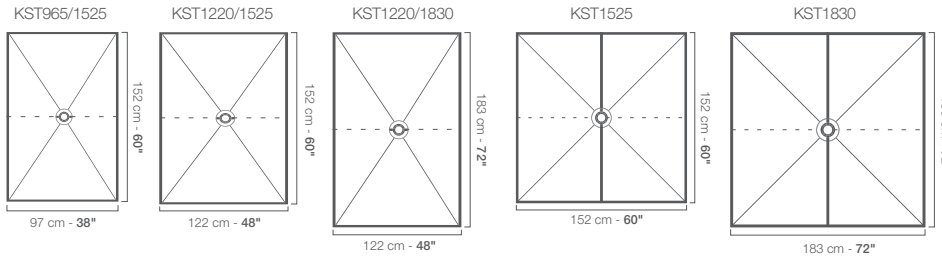

Schluter®-KERDI-SHOWER-T				
Tray with center drain placement				
Item No.	Dimensions	Perimeter height	Drain placement	\$ / Unit
KST 965/1525	97 cm x 152 cm - 38" x 60"	29 mm - 1-1/8"	center	144.86
KST 1220/1525	122 cm x 152 cm - 48" x 60"	28 mm - 1-3/32"	center	215.74
KST 1220/1830	122 cm x 183 cm - 48" x 72"	32 mm - 1-1/4"	center	231.16
KST 1525	152 cm x 152 cm - 60" x 60"	30 mm - 1-3/16"	center	283.55
KST 1830	183 cm x 183 cm - 72" x 72"	32 mm - 1-1/4"	center	308.20

The **KERDI-SHOWER-TS** is the standard tray with off-center drain placement.

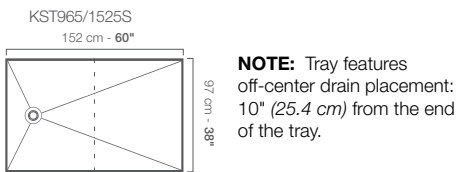

Schluter®-KERDI-SHOWER-TS				
Tray with off-center drain placement				
Item No.	Dimensions	Perimeter height	Drain placement	\$ / Unit
KST 965/1525 S	97 cm x 152 cm - 38" x 60"	29 mm - 1-1/8"	off-center	144.86

The **KERDI-SHOWER-TT** features a thin perimeter height that simplifies the construction of curbless showers.

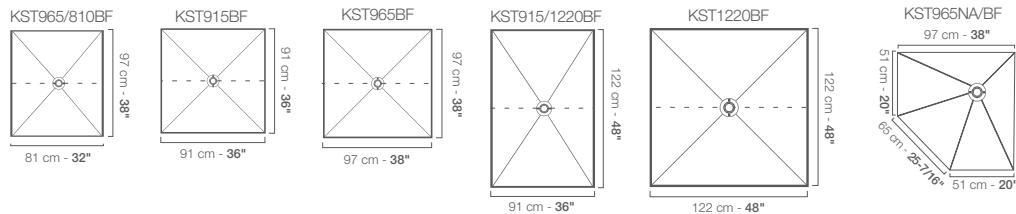

NEO ANGLE TRAY:

- Features off-center drain placement: 12" (30.5 cm) from the 38" (97 cm) sides of the tray.
- Includes two 135° inside waterproofing corners.



Schluter®-KERDI-SHOWER-TT				
Thin tray				
Item No.	Dimensions	Perimeter height	Drain placement	\$ / Unit
KST 965/810 BF	81 cm x 97 cm - 32" x 38"	23 mm - 29/32"	center	141.78
KST 915 BF	91 cm x 91 cm - 36" x 36"	22 mm - 7/8"	center	107.87
KST 965 BF	97 cm x 97 cm - 38" x 38"	23 mm - 29/32"	center	120.19
KST 915/1220 BF	91 cm x 122 cm - 36" x 48"	25 mm - 1"	center	166.43
KST 1220 BF	122 cm x 122 cm - 48" x 48"	25 mm - 1"	center	132.53
KST 965NA/ BF	97 cm x 97 cm - 38" x 38" Neo angle	26 mm - 1-1/32"	off-center	147.94



Schluter®-KERDI-SHOWER-LT/LTS

Schluter®-KERDI-SHOWER-LT/-LTS are polystyrene sloped trays with integrated Schluter®-KERDI waterproofing. Each of these prefabricated shower trays is designed to integrate with the Schluter®-KERDI-LINE.

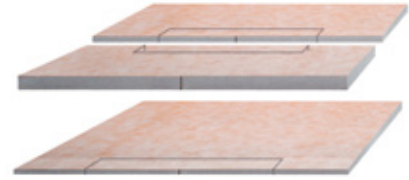

The **KERDI-SHOWER-LT** allows for the installation of a center drain.

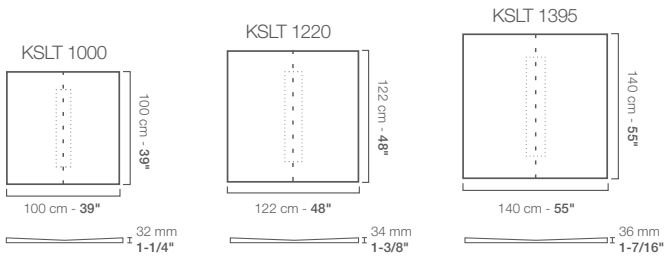

Schluter®-KERDI-SHOWER-LT

Tray with center linear drain placement

Item No.	Dimensions	Height at ends	Drain placement	\$ / Unit
KSLT 1000	100 cm x 100 cm - 39" x 39"	32 mm - 1-1/4"	center	217.71
KSLT 1220	122 cm x 122 cm - 48" x 48"	34 mm - 1-3/8"	center	290.33
KSLT 1395	140 cm x 140 cm - 55" x 55"	36 mm - 1-7/16"	center	365.82

The **KERDI-SHOWER-LTS** accommodates the installation of the drain along the perimeter of the shower.

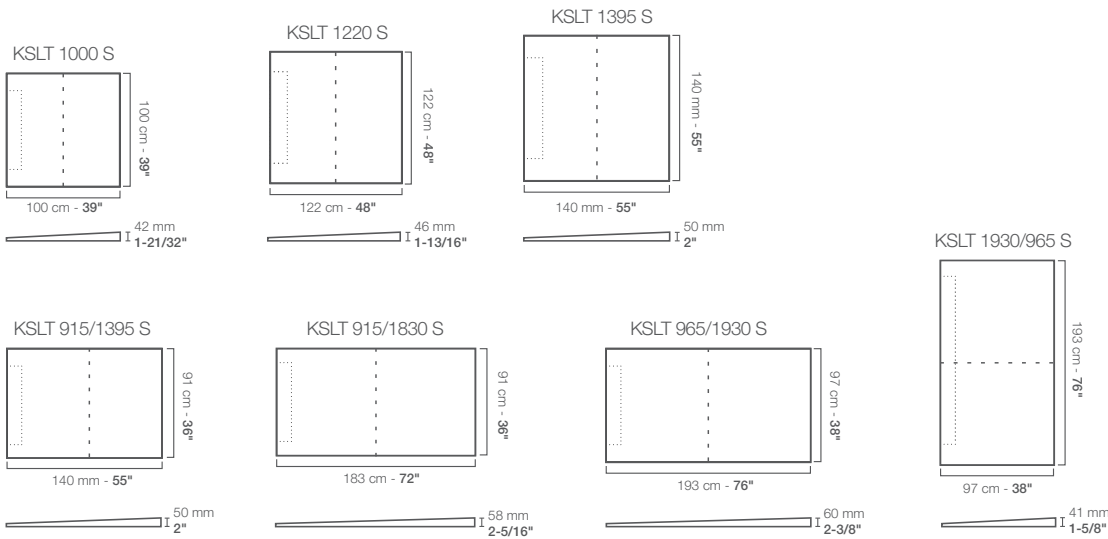

Schluter®-KERDI-SHOWER-LTS

Tray with perimeter linear drain placement

Item No.	Dimensions	Height at end	Drain placement	\$ / Unit
KSLT 1000 S	100 cm x 100 cm - 39" x 39"	42 mm - 1-21/32"	perimeter	217.71
KSLT 1220 S	122 cm x 122 cm - 48" x 48"	46 mm - 1-13/16"	perimeter	290.33
KSLT 1395 S	140 cm x 140 cm - 55" x 55"	50 mm - 2"	perimeter	365.82
KSLT 915/1395 S	91 cm x 140 cm - 36" x 55"	50 mm - 2"	perimeter	255.48
KSLT 915/1830 S	91 cm x 183 cm - 36" x 72"	58 mm - 2-5/16"	perimeter	342.59
KSLT 965/1930 S	97 cm x 193 cm - 38" x 76"	60 mm - 2-3/8"	perimeter	377.43
KSLT 1930/965 S	193 cm x 97 cm - 76" x 38"	41 mm - 1-5/8"	perimeter	377.43



Schluter®-KERDI-SHOWER-R

Schluter®-KERDI-SHOWER-R is a lightweight, expanded polystyrene shower ramp with integrated Schluter®-KERDI waterproofing designed to facilitate the construction of access ramps for tiled showers. The ramp integrates with the Schluter®-Shower System to create accessible, curbless showers and adheres to the ADA's slope ratio.

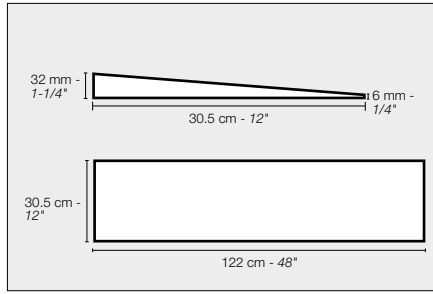

Schluter®-KERDI-SHOWER-R			
Ramp			
Item No.	Length	Width	\$ / Unit
KSR 305/1220	122 cm - 48"	30.5 cm - 12"	110.75

Schluter®-KERDI-BOARD-SC

Schluter®-KERDI-BOARD-SC is a prefabricated shower curb made of KERDI-BOARD that is designed to integrate with the Schluter®-Shower System. The curb is lightweight, stable, and load bearing. It can be used in conjunction with the KERDI-SHOWER prefabricated shower trays as well as in mortar bed applications. KERDI-BOARD-SC is quick and easy to install, waterproof and ready to tile, making it a simple solution for tiled shower curbs.

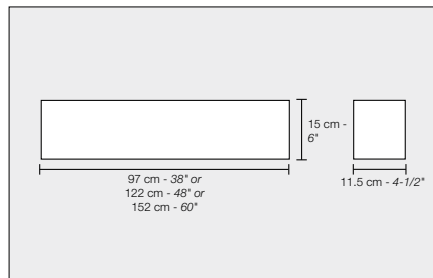

Schluter®-KERDI-BOARD-SC				
Curb				
Item No.	Length	Width	Height	\$ / Unit
KBSC 115 150 970	97 cm - 38"	11.5 cm - 4-1/2"	15 cm - 6"	65.85
KBSC 115 150 1220	122 cm - 48"	11.5 cm - 4-1/2"	15 cm - 6"	71.83
KBSC 115 150 1524	152 cm - 60"	11.5 cm - 4-1/2"	15 cm - 6"	105.35

⚠ WARNING: Cancer and Reproductive Harm - www.P65Warnings.ca.gov

Schluter®-KERDI-BOARD-SB

Schluter®-KERDI-BOARD-SB is a prefabricated shower bench made of KERDI-BOARD that is designed to integrate with the Schluter®-Shower System. The bench is lightweight, stable, and load bearing. It features a sloped surface to prevent the accumulation of water. KERDI-BOARD-SB is quick and easy to install, waterproof and ready to tile, making it a simple solution for tiled shower benches.

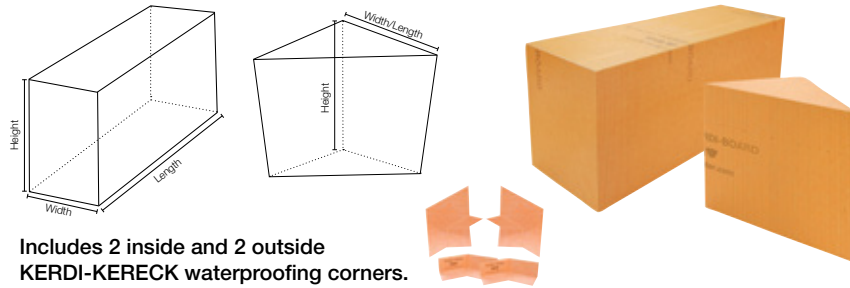

Includes 2 inside and 2 outside KERDI-KERECK waterproofing corners.

Schluter®-KERDI-BOARD-SB					
Bench					
Item No.	Length	Width	Height	Shape	\$/ Unit
KBSB 410 TA	41 cm - 16"	41 cm - 16"	51 cm - 20"	Triangular	181.97
KBSB 610 TA	61 cm - 24"	61 cm - 24"	51 cm - 20"	Triangular	237.05
KBSB 290 970 RA	97 cm - 38"	29 cm - 11-1/2"	51 cm - 20"	Rectangular	293.32
KBSB 410 1220 RA	122 cm - 48"	41 cm - 16"	51 cm - 20"	Rectangular	389.10

⚠ WARNING: Cancer and Reproductive Harm - www.P65Warnings.ca.gov

Schluter®-KERDI-BOARD-SN

Schluter®-KERDI-BOARD-SN is a prefabricated shower niche made of Schluter®-KERDI-BOARD that can be installed in both Schluter®-KERDI and KERDI-BOARD wall assemblies. The shower niche features a 1/2" (12.5 mm) -thick by 2" (50 mm) -wide integrated bonding flange and is available in 4 different sizes.

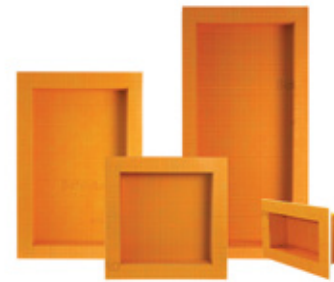
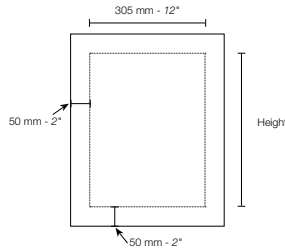

Schluter®-KERDI-BOARD-SN					
Niche					
Item No.	Height	Width	Depth	Shelf	\$/ Unit
KB 12 SN 305 152 A	152 mm - 6"	305 mm - 12"	89 mm - 3-1/2"	-	65.26
KB 12 SN 305 305 A	305 mm - 12"	305 mm - 12"	89 mm - 3-1/2"	-	78.16
KB 12 SN 305 508 A1	508 mm - 20"	305 mm - 12"	89 mm - 3-1/2"	1	105.65
KB 12 SN 305 711 A1	711 mm - 28"	305 mm - 12"	89 mm - 3-1/2"	1	126.27

⚠ WARNING: Cancer and Reproductive Harm - www.P65Warnings.ca.gov



NEW! Schluter®-KERDI-BOARD-SNLT

Shower niche with integrated LIPROTEC LED lighting

Schluter's illuminated profile technology offers a unique and innovative solution to add a touch of elegance and functionality to tile installations. KERDI-BOARD-SNLT shower niches feature integrated LIPROTEC LED lighting that beautifully illuminates tiled surfaces, enhancing the ambiance of the shower area. The waterproof cable connection box in the top of the niche, allows for a code-compliant installation of electrical elements in a wet area.









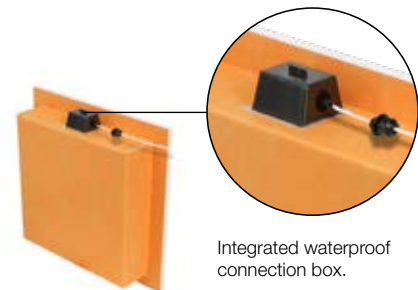
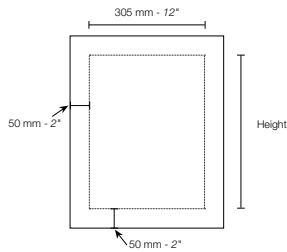

▲ Schluter®-KERDI-BOARD-SNLT

Schluter®-KERDI-BOARD-SNLT is a prefabricated shower niche made of KERDI-BOARD that incorporates a mounting profile with a diffused Schluter®-LIPROTEC LED light strip. A pre-installed, waterproof connection box at the top of the niche ensures that the electrical connection is code compliant. KERDI-BOARD-SNLT features a 1/2" (12.5 mm) -thick by 2" (50 mm) -wide integrated bonding flange and is available in 3 sizes designed for a vertical installation.

The mounting profile is made of anodized aluminum with satin finish (AE). It is 11.8" (300 mm) long to fit along the top of the niche and features a cut out designed to pass the cable through. The LED light strip is encased in a silicone tube that nests into the mounting profile and provides an evenly diffused line of light. The niche includes a stainless steel connection box and cover which are inserted into the pre-installed connection box. Also included is a self-adhesive patch used for proper thin-set mortar adhesion and to prevent mortar from entering the connection box. It is not intended for waterproofing.



Integrated waterproof connection box.

Contents			
	1x Niche		1x Mounting profile
			1x LED strip (warm white)
			1x Stainless steel connection box with cover
			1x Self-adhesive patch

Lighting facts	
Brightness	118 lumens
Energy used	1.7 watts
Color accuracy (Color rendering index - CRI)	95+
Light appearance	
	
3000K Warm white	

Schluter®-KERDI-BOARD-SNLT						
Niche with LIPROTEC LED lighting						
Item No.	Height	Width	Depth	LED color	Shelf	\$ / Unit
KB 12 SNLT 1 WW	305 mm - 12"	305 mm - 12"	89 mm - 3-1/2"	Warm white	-	309.04
KB 12 SNLT 2 WW	508 mm - 20"	305 mm - 12"	89 mm - 3-1/2"	Warm white	-	326.98
KB 12 SNLT 3 WW	711 mm - 28"	305 mm - 12"	89 mm - 3-1/2"	Warm white	1	356.70

⚠ **WARNING:** Cancer and Reproductive Harm - www.P65Warnings.ca.gov



Schluter®-LIPROTEC-ECX

Schluter®-LIPROTEC-ECX is an all-in-one LED power supply and in-wall dimmer switch that eliminates compatibility issues between drivers and dimmer switches. LIPROTEC-ECX is designed for use with the KERDI-BOARD-SNLT niche with white LED strip. Three interchangeable face plates (white, light almond, and dark brown) are included to match most decors.

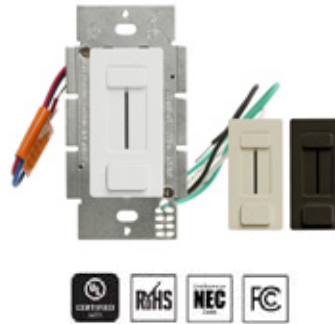

Note: the trim plate must be purchased separately.

- Dimming range: 5% to 100%
- Can control multiple KERDI-BOARD-SNLT niches (up to 60 watts)
- Fits in a standard electrical box
- UL listed in USA and Canada

Schluter®-LIPROTEC-ECX				
LED driver and dimmer				
Item No.	Input	Output	Power	\$ / Unit
LT ECX 1W	120V AC	24V DC	60 W	264.45

⚠ WARNING: Cancer and Reproductive Harm - www.P65Warnings.ca.gov

Schluter®-LIPROTEC-ECD

Schluter®-LIPROTEC-ECD is an in-line dimmable driver that is hard wired into your electrical, designed for use with the KERDI-BOARD-SNLT niche with white LED strip. It is compatible with a range of popular dimmer switches, allowing you to have matching light switches throughout your bathroom. LIPROTEC-ECD includes a metal enclosure and must be installed in an accessible location, such as a closet or vanity.



Note: a compatible dimmer switch must be purchased separately, refer to the compatibility list on www.schluter.com

- Dimming range: 5% to 100%
- Can control multiple KERDI-BOARD-SNLT niches (up to 24 watts)
- UL listed in USA and Canada

Schluter®-LIPROTEC-ECD				
Dimmable LED driver				
Item No.	Input	Output	Power	\$ / Unit
LT ECD 1W	120V AC	24V DC	24 W	160.93

⚠ WARNING: Cancer and Reproductive Harm - www.P65Warnings.ca.gov

Schluter®-LIPROTEC-CW

Schluter®-LIPROTEC-CW cables are designed to connect the KERDI-BOARD-SNLT niche to the LIPROTEC-ECX or ECD power supply. The cables feature a pre-installed waterproof snap-in gland for a secure connection to the top of the niche, and connectors to attach the LED strip. LIPROTEC-CW is rated for in-wall installation (no conduit required).



- Class 2 low voltage cable (CL2)
- CSA FT4 rated (80°C)
- UL listed in USA and Canada

Schluter®-LIPROTEC-CW				
Cable for LIPROTEC white LED system				
Item No.	Length	Gauge	Conductors	\$ / Unit
LT CW / 4M	4 m – 13' 1-1/2"	20AWG	2	48.69
LT CW / 8M	8 m – 26' 3"	20AWG	2	78.93
LT CW / 15M	15 m – 49' 2-1/2"	20AWG	2	137.35

⚠ WARNING: Cancer and Reproductive Harm - www.P65Warnings.ca.gov



Shower & Tub Kits

Our kits are convenient solutions to providing all the components required to build waterproof showers and bathtub surrounds. With various sizes, options, and configurations, there's a perfect kit for virtually every bathroom project.



Schluter®-KERDI-SHOWER-KIT

The **Schluter®-KERDI-SHOWER-KIT** is an all-inclusive package containing each of the integrated family of components required to create a maintenance-free, watertight shower assembly without a mortar bed.

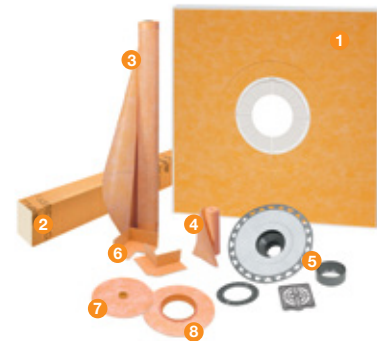
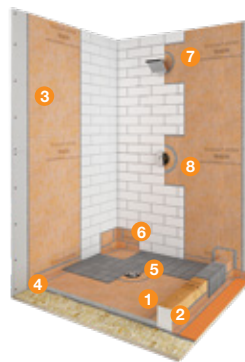

Schluter®-KERDI-SHOWER-KIT

Includes	Description	Quantity	
		48" x 48"	38" x 60"
1 KERDI-SHOWER-T/-TS/-TT	Shower Tray	1	1
2 KERDI-BOARD-SC	Shower Curb 122 cm x 15 cm x 11.5 cm - 48" x 6" x 4-1/2"	1	
KERDI-BOARD-SC	Shower Curb 97 cm x 15 cm x 11.5 cm - 38" x 6" x 4-1/2"		2
3 KERDI 10 M	Waterproofing membrane 1 m x 10 m = 10 m ² - 3' 3" x 33' = 108 ft ²	1	1
4 KERDI-BAND	Waterproofing strip 125 mm x 10 m - 5" x 33'	1	1
5 KERDI-DRAIN	Flange with 50 mm – 2" outlet and stainless steel grate (E)	1	1
6 KERDI-KERECK-F	Preformed waterproofing corners	4 inside and 2 outside	
7 KERDI-SEAL-PS	Pipe seal 20 mm – 3/4"	1	
8 KERDI-SEAL-MV	Mixing valve seal 114 mm – 4-1/4"	1	

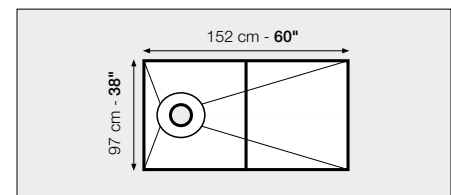
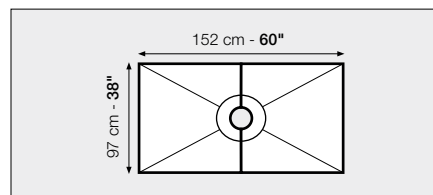
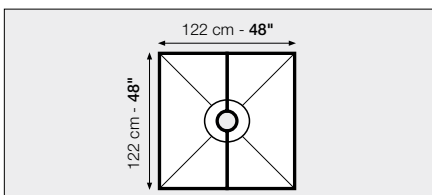

48" x 48" Kit - ABS or PVC			
Item No.	Drain Material	Grate finish	\$ / Kit
KSK 1220 ABS E	ABS	E	628.67
KSK 1220 PVC E	PVC	E	628.67

38" x 60" Kit - ABS or PVC			
Item No.	Drain Material	Grate finish	\$ / Kit
KSK 965 1525 ABS E	ABS	E	682.34
KSK 965 1525 PVC E	PVC	E	682.34

38" x 60" Kit off-center - ABS or PVC			
Item No.	Drain Material	Grate finish	\$ / Kit
KSK 965 1525S ABSE	ABS	E	682.34
KSK 965 1525S PVCE	PVC	E	682.34

⚠ WARNING: Cancer and Reproductive Harm - www.P65Warnings.ca.gov

Note: Tray features off-center drain placement: 10" (25.4 cm) o.c. from end of tray.



Schluter®-KERDI-SHOWER-KIT

WITHOUT THE GRATE

This kit contains all the elements of the complete KERDI-SHOWER-KIT except the drain grate. This simplifies the stocking of a wide variety of KERDI-SHOWER-T/-TS/-TT tray and KERDI-DRAIN grate combinations.

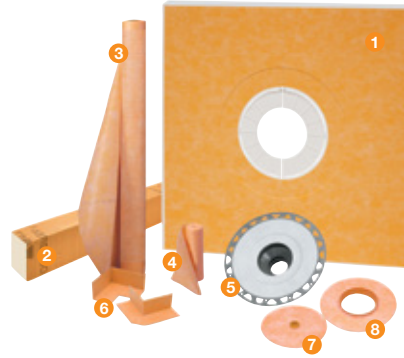

KERDI-DRAIN Grates
sold separately

See pages 132-135

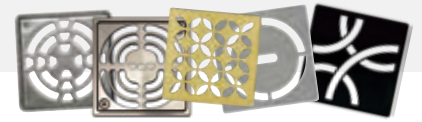

Includes		Description	Quantity			
			48" x 48"	38" x 60"	48" x 72"	72" x 72"
1	KERDI-SHOWER-T/-TS/-TT	Shower Tray	1	1	1	1
2	KERDI-BOARD-SC	Shower Curb 122 cm x 15 cm x 11.5 cm - 48" x 6" x 4-1/2"	1			
	KERDI-BOARD-SC	Shower Curb 97 cm x 15 cm x 11.5 cm - 38" x 6" x 4-1/2"		2	2	2
3	KERDI 5 M	Waterproofing membrane 1 m x 5 m = 5 m ² - 3' 3" x 16' 5" = 54 ft ²				1
	KERDI 10 M	Waterproofing membrane 1 m x 10 m = 10 m ² - 3' 3" x 33' = 108 ft ²	1	1		1
	KERDI 12 M	Waterproofing membrane 1 m x 12 m = 12 m ² - 3' 3" x 39' 4" = 128 ft ²			1	
4	KERDI-BAND	Waterproofing strip 125 mm x 10 m - 5" x 33'			2	
5	KERDI-DRAIN Flange	Flange with 50 mm - 2" outlet	1	1	1	1
6	KERDI-KERECK-F	Preformed waterproofing corners	4 inside and 2 outside			
7	KERDI-SEAL-PS	Pipe seal 20 mm - 3/4"	1			
8	KERDI-SEAL-MV	Mixing valve seal 114 mm - 4-1/4"	1			

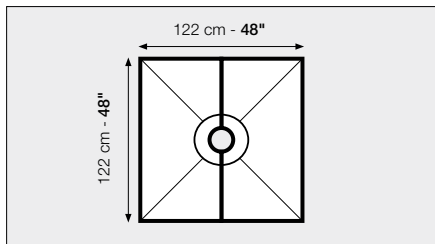

48" x 48" Kit - ABS or PVC		
Item No.	Drain Material	\$ / Kit
KSK 1220 ABS	ABS	571.90
KSK 1220 PVC	PVC	571.90

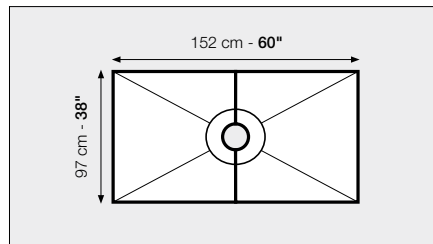

38" x 60" Kit - ABS or PVC		
Item No.	Drain Material	\$ / Kit
KSK 965 1525 ABS	ABS	625.29
KSK 965 1525 PVC	PVC	625.29

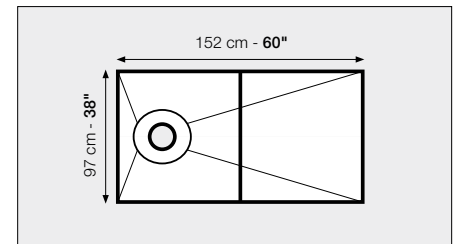

38" x 60" Kit off-center - ABS or PVC		
Item No.	Drain Material	\$ / Kit
KSK 965 1525S ABS	ABS	625.29
KSK 965 1525S PVC	PVC	625.29

Note: Tray features off-center drain placement: 10" (25.4 cm) o.c. from end of tray.

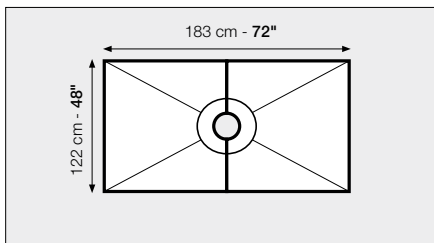

48" x 72" Kit - ABS or PVC		
Item No.	Drain Material	\$ / Kit
KSK 1220 1830 ABS	ABS	841.19
KSK 1220 1830 PVC	PVC	841.19

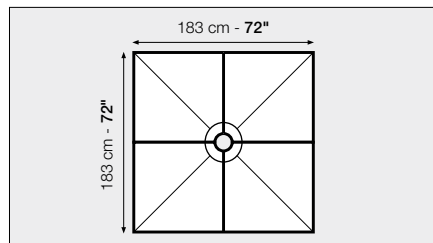

72" x 72" Kit - ABS or PVC		
Item No.	Drain Material	\$ / Kit
KSK 1830 ABS	ABS	980.88
KSK 1830 PVC	PVC	980.88

WARNING: Cancer and Reproductive Harm - www.P65Warnings.ca.gov

Schluter®-KERDI-SHOWER-KIT

WITHOUT THE DRAIN

This kit contains all the elements of the complete KERDI-SHOWER-KIT except the KERDI-DRAIN. This simplifies the stocking of a wide variety of KERDI-SHOWER-T/-TS/-TT trays and KERDI-DRAIN combinations.

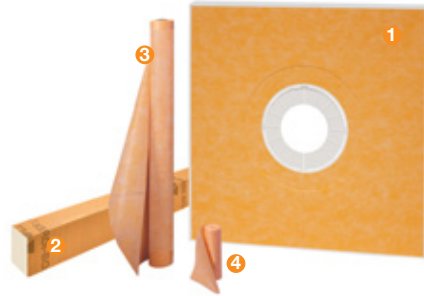

KERDI-DRAIN grates and flanges sold separately

Grates - See pages 132-135
Flanges - See pages 136-139

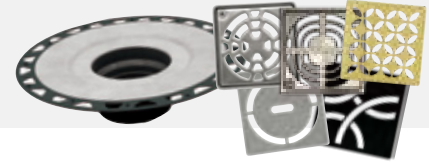

Schluter®-KERDI-SHOWER-KIT - WITHOUT THE DRAIN

Includes	Description	Quantity			
		48" x 48"	38" x 60"	48" x 72"	72" x 72"
① KERDI-SHOWER-T/-TS/-TT	Shower Tray	1	1	1	1
② KERDI-BOARD-SC	Shower Curb 122 cm x 15 cm x 11.5 cm - 48" x 6" x 4-1/2"	1			
	KERDI-BOARD-SC		2	2	2
③ KERDI 5 M	Waterproofing membrane 1 m x 5 m = 5 m ² - 3' 3" x 16' 5" = 54 ft²				1
	KERDI 10 M	1	1		1
	KERDI 12 M			1	
④ KERDI-BAND	Waterproofing strip 125 mm x 10 m - 5" x 33'	1	1	2	2

Tray size	Item No.	\$ / Kit
122 cm x 122 cm - 48" x 48"	KSK 1220	482.95
97 cm x 152 cm - 38" x 60"	KSK 965 1525	536.33
97 cm x 152 cm - 38" x 60" off-center drain	KSK 965 1525S	536.33
122 cm x 183 cm - 48" x 72"	KSK 1220 1830	752.23
183 cm x 183 cm - 72" x 72"	KSK 1830	891.93

⚠ WARNING: Cancer and Reproductive Harm - www.P65Warnings.ca.gov



Schluter®-KERDI-TUBKIT

The **Schluter®-KERDI-TUBKIT** contains all the components necessary to create a fully waterproof and vapor tight bathtub surround assembly.



Schluter®-KERDI-TUBKIT		
Includes	Description	Quantity
1 KERDI 7M	Waterproofing membrane 1 m x 7 m = 7 m ² - 3' 3" x 23' = 75 ft ²	1
2 KERDI-BAND	Waterproofing strip 125 mm x 5 m - 5" x 16' 5"	1
3 KERDI-SEAL-PS	Pipe seal 20 mm - 3/4"	1
4 KERDI-SEAL-MV	Mixing valve seal 114 mm - 4-1/4"	1
5 KERDI-FIX	Sealing and bonding compound, bright white (290 ml – 9.81 fl oz)	1

Item No.	\$ / Kit
KKB7	263.39

⚠ WARNING: Reproductive Harm - www.P65Warnings.ca.gov

Schluter®-KERDI-BOARD-KIT

The **Schluter®-KERDI-BOARD-KIT** contains KERDI-BOARD panels and all the other components necessary to create a fully waterproof and vapor tight tile application around bathtubs and acrylic shower bases, all in one convenient package.



Schluter®-KERDI-BOARD-KIT

Includes	Description	Quantity
① KERDI-BOARD	Waterproof building panel 1.25 cm x 122 cm x 97 cm - 1/2" x 48" x 38" Total coverage = 9.4 m ² - 101 ft ²	8
② KERDI-BAND	Waterproofing strip 125 mm x 30 m - 5" x 98' 5"	1
③ KERDI-SEAL-PS	Pipe seal	1x 12.5 mm - 1/2" 1x 20 mm - 3/4"
④ KERDI-SEAL-MV	Mixing valve seal 114 mm - 4-1/4"	1
⑤ KERDI-BOARD-ZT/-ZS	Screws and washers	140
⑥ KERDI-FIX	Sealing and bonding compound, bright white (290 ml – 9.81 fl oz)	2

Item No.	\$ / Kit
KBKIT	714.74

⚠ WARNING: Cancer and Reproductive Harm www.P65Warnings.ca.gov





Shower Accessories

Accessories are used to enhance tiled shower applications, providing shelving, splashguards at the entrances to curbless showers, support channels for glass walls, and wall finishing that eliminates the need to cut wedges of tile in KERDI-LINE applications.



Schluter®-SHELF: NEW colors available!

(pages 166-175)



Dark anthracite (TSDA)

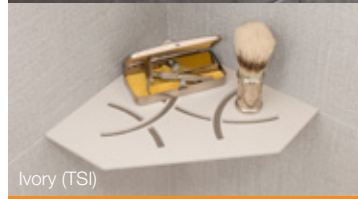

Ivory (TSl)



Pewter (TSG)



Schluter®-SHELF-W

Schluter®-SHELF-W is a rectangular shelf designed for tiled walls. The shelf is made of either brushed stainless steel, or color-coated aluminum in a choice of 9 TRENDLINE colors. SHELF-W features a double anchoring leg for installation in tandem with tile. Matching KERDI-DRAIN and KERDI-LINE grates are also available.

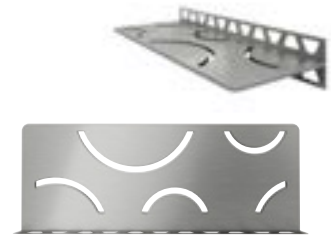
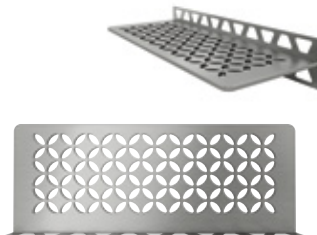
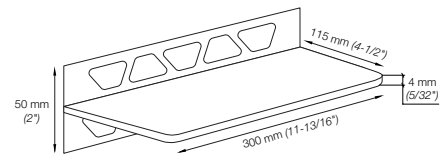
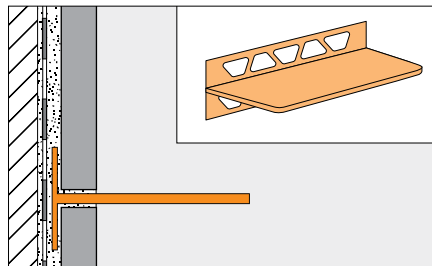

Schluter®-SHELF-W		
FLORAL		
Item No.	Finish	\$ / Unit
Stainless steel		
SWS1 D5 EB	Brushed stainless steel (EB)	136.38
Color-coated aluminum		
SWS1 D5 MBW	Matte white (MBW)	116.21
SWS1 D5 TSI	▲ Ivory (TSI)	116.21
SWS1 D5 TSBG	Greige (TSBG)	116.21
SWS1 D5 TSC	Cream (TSC)	116.21
SWS1 D5 TSOB	Bronze (TSOB)	116.21
SWS1 D5 TSSG	Stone grey (TSSG)	116.21
SWS1 D5 TSG	▲ Pewter (TSG)	116.21
SWS1 D5 TSDA	▲ Dark anthracite (TSDA)	116.21
SWS1 D5 MGS	Matte black (MGS)	116.21

Schluter®-SHELF-W		
CURVE		
Item No.	Finish	\$ / Unit
Stainless steel		
SWS1 D6 EB	Brushed stainless steel (EB)	130.43
Color-coated aluminum		
SWS1 D6 MBW	Matte white (MBW)	97.24
SWS1 D6 TSI	▲ Ivory (TSI)	97.24
SWS1 D6 TSBG	Greige (TSBG)	97.24
SWS1 D6 TSC	Cream (TSC)	97.24
SWS1 D6 TSOB	Bronze (TSOB)	97.24
SWS1 D6 TSSG	Stone grey (TSSG)	97.24
SWS1 D6 TSG	▲ Pewter (TSG)	97.24
SWS1 D6 TSDA	▲ Dark anthracite (TSDA)	97.24
SWS1 D6 MGS	Matte black (MGS)	97.24

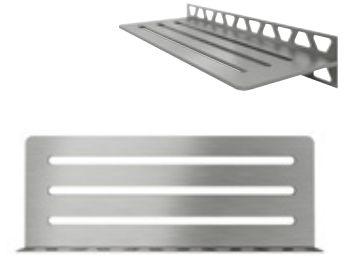
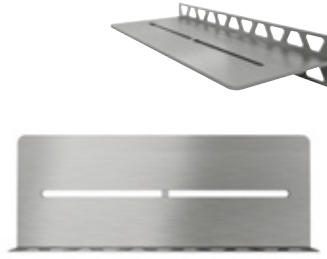

Schluter®-SHELF-W		
PURE		
Item No.	Finish	\$ / Unit
Stainless steel		
SWS1 D7 EB	Brushed stainless steel (EB)	130.43
Color-coated aluminum		
SWS1 D7 MBW	Matte white (MBW)	97.24
SWS1 D7 TSI	▲ Ivory (TSI)	97.24
SWS1 D7 TSBG	Greige (TSBG)	97.24
SWS1 D7 TSC	Cream (TSC)	97.24
SWS1 D7 TSOB	Bronze (TSOB)	97.24
SWS1 D7 TSSG	Stone grey (TSSG)	97.24
SWS1 D7 TSG	▲ Pewter (TSG)	97.24
SWS1 D7 TSDA	▲ Dark anthracite (TSDA)	97.24
SWS1 D7 MGS	Matte black (MGS)	97.24

Schluter®-SHELF-W		
WAVE		
Item No.	Finish	\$ / Unit
Stainless steel		
SWS1 D10 EB	Brushed stainless steel (EB)	136.38
Color-coated aluminum		
SWS1 D10 MBW	Matte white (MBW)	116.21
SWS1 D10 TSI	▲ Ivory (TSI)	116.21
SWS1 D10 TSBG	Greige (TSBG)	116.21
SWS1 D10 TSC	Cream (TSC)	116.21
SWS1 D10 TSOB	Bronze (TSOB)	116.21
SWS1 D10 TSSG	Stone grey (TSSG)	116.21
SWS1 D10 TSG	▲ Pewter (TSG)	116.21
SWS1 D10 TSDA	▲ Dark anthracite (TSDA)	116.21
SWS1 D10 MGS	Matte black (MGS)	116.21

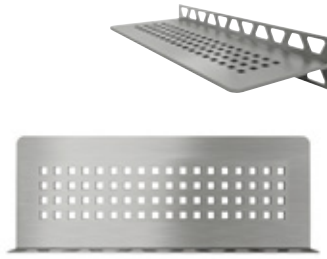

Schluter®-SHELF-W		
SQUARE		
Item No.	Finish	\$ / Unit
Stainless steel		
SWS1 D3 EB	Brushed stainless steel (EB)	136.38
Color-coated aluminum		
SWS1 D3 MBW	Matte white (MBW)	116.21
SWS1 D3 TSI	▲ Ivory (TSI)	116.21
SWS1 D3 TSBG	Greige (TSBG)	116.21
SWS1 D3 TSC	Cream (TSC)	116.21
SWS1 D3 TSOB	Bronze (TSOB)	116.21
SWS1 D3 TSSG	Stone grey (TSSG)	116.21
SWS1 D3 TSG	▲ Pewter (TSG)	116.21
SWS1 D3 TSDA	▲ Dark anthracite (TSDA)	116.21
SWS1 D3 MGS	Matte black (MGS)	116.21



Stainless steel

Color-coated aluminum





Schluter®-SHELVE

Schluter®-SHELVE is a corner shelf designed for tiled walls. The shelf is made of either brushed stainless steel, or color-coated aluminum in a choice of 9 TRENDLINE colors. SHELVE features 3/32" (2 mm) -thick anchoring tabs which allow for easy installation either in tandem with tile or as a retrofit application. Matching KERDI-DRAIN and KERDI-LINE grates are also available.

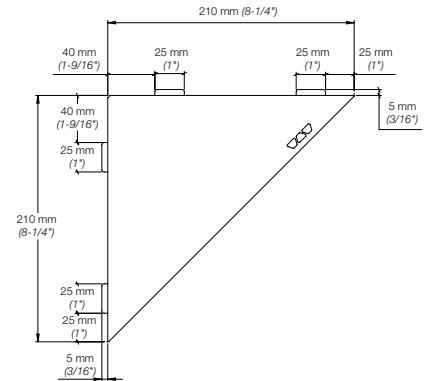
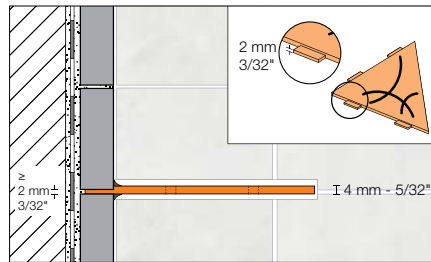

Triangular Corner Shelf

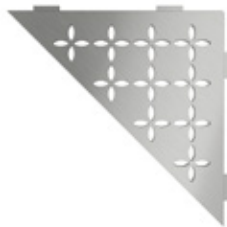

Schluter®-SHELVE		
FLORAL		
Item No.	Finish	\$ / Unit
Stainless steel		
SES1 D5 EB	Brushed stainless steel (EB)	117.40
Color-coated aluminum		
SES1 D5 MBW	Matte white (MBW)	88.94
SES1 D5 TSI	▲ Ivory (TSI)	88.94
SES1 D5 TSBG	Greige (TSBG)	88.94
SES1 D5 TSC	Cream (TSC)	88.94
SES1 D5 TSOB	Bronze (TSOB)	88.94
SES1 D5 TSSG	Stone grey (TSSG)	88.94
SES1 D5 TSG	▲ Pewter (TSG)	88.94
SES1 D5 TSDA	▲ Dark anthracite (TSDA)	88.94
SES1 D5 MGS	Matte black (MGS)	88.94

Schluter®-SHELVE		
CURVE		
Item No.	Finish	\$ / Unit
Stainless steel		
SES1 D6 EB	Brushed stainless steel (EB)	112.66
Color-coated aluminum		
SES1 D6 MBW	Matte white (MBW)	83.00
SES1 D6 TSI	▲ Ivory (TSI)	83.00
SES1 D6 TSBG	Greige (TSBG)	83.00
SES1 D6 TSC	Cream (TSC)	83.00
SES1 D6 TSOB	Bronze (TSOB)	83.00
SES1 D6 TSSG	Stone grey (TSSG)	83.00
SES1 D6 TSG	▲ Pewter (TSG)	83.00
SES1 D6 TSDA	▲ Dark anthracite (TSDA)	83.00
SES1 D6 MGS	Matte black (MGS)	83.00



Schluter®-SHELF-E		
PURE		
Item No.	Finish	\$ / Unit
Stainless steel		
SES1 D7 EB	Brushed stainless steel (EB)	112.66
Color-coated aluminum		
SES1 D7 MBW	Matte white (MBW)	83.00
SES1 D7 TSI	▲ Ivory (TSI)	83.00
SES1 D7 TSBG	Greige (TSBG)	83.00
SES1 D7 TSC	Cream (TSC)	83.00
SES1 D7 TSOB	Bronze (TSOB)	83.00
SES1 D7 TSSG	Stone grey (TSSG)	83.00
SES1 D7 TSG	▲ Pewter (TSG)	83.00
SES1 D7 TSDA	▲ Dark anthracite (TSDA)	83.00
SES1 D7 MGS	Matte black (MGS)	83.00

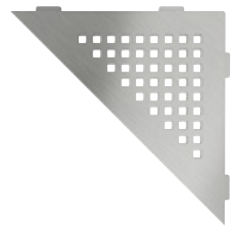

Schluter®-SHELF-E		
WAVE		
Item No.	Finish	\$ / Unit
Stainless steel		
SES1 D10 EB	Brushed stainless steel (EB)	117.40
Color-coated aluminum		
SES1 D10 MBW	Matte white (MBW)	88.94
SES1 D10 TSI	▲ Ivory (TSI)	88.94
SES1 D10 TSBG	Greige (TSBG)	88.94
SES1 D10 TSC	Cream (TSC)	88.94
SES1 D10 TSOB	Bronze (TSOB)	88.94
SES1 D10 TSSG	Stone grey (TSSG)	88.94
SES1 D10 TSG	▲ Pewter (TSG)	88.94
SES1 D10 TSDA	▲ Dark anthracite (TSDA)	88.94
SES1 D10 MGS	Matte black (MGS)	88.94

Schluter®-SHELF-E		
SQUARE		
Item No.	Finish	\$ / Unit
Stainless steel		
SES1 D3 EB	Brushed stainless steel (EB)	117.40
Color-coated aluminum		
SES1 D3 MBW	Matte white (MBW)	88.94
SES1 D3 TSI	▲ Ivory (TSI)	88.94
SES1 D3 TSBG	Greige (TSBG)	88.94
SES1 D3 TSC	Cream (TSC)	88.94
SES1 D3 TSOB	Bronze (TSOB)	88.94
SES1 D3 TSSG	Stone grey (TSSG)	88.94
SES1 D3 TSG	▲ Pewter (TSG)	88.94
SES1 D3 TSDA	▲ Dark anthracite (TSDA)	88.94
SES1 D3 MGS	Matte black (MGS)	88.94

Stainless steel

Color-coated aluminum



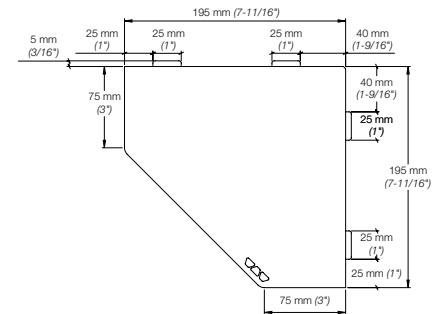

Pentagonal Corner Shelf

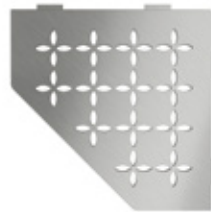

Schluter®-SHELF-E		
FLORAL		
Item No.	Finish	\$ / Unit
Stainless steel		
SES2 D5 EB	Brushed stainless steel (EB)	117.40
Color-coated aluminum		
SES2 D5 MBW	Matte white (MBW)	100.79
SES2 D5 TSI	▲ Ivory (TSI)	100.79
SES2 D5 TSBG	Greige (TSBG)	100.79
SES2 D5 TSC	Cream (TSC)	100.79
SES2 D5 TSOB	Bronze (TSOB)	100.79
SES2 D5 TSSG	Stone grey (TSSG)	100.79
SES2 D5 TSG	▲ Pewter (TSG)	100.79
SES2 D5 TSDA	▲ Dark anthracite (TSDA)	100.79
SES2 D5 MGS	Matte black (MGS)	100.79

Schluter®-SHELF-E		
CURVE		
Item No.	Finish	\$ / Unit
Stainless steel		
SES2 D6 EB	Brushed stainless steel (EB)	112.66
Color-coated aluminum		
SES2 D6 MBW	Matte white (MBW)	93.69
SES2 D6 TSI	▲ Ivory (TSI)	93.69
SES2 D6 TSBG	Greige (TSBG)	93.69
SES2 D6 TSC	Cream (TSC)	93.69
SES2 D6 TSOB	Bronze (TSOB)	93.69
SES2 D6 TSSG	Stone grey (TSSG)	93.69
SES2 D6 TSG	▲ Pewter (TSG)	93.69
SES2 D6 TSDA	▲ Dark anthracite (TSDA)	93.69
SES2 D6 MGS	Matte black (MGS)	93.69

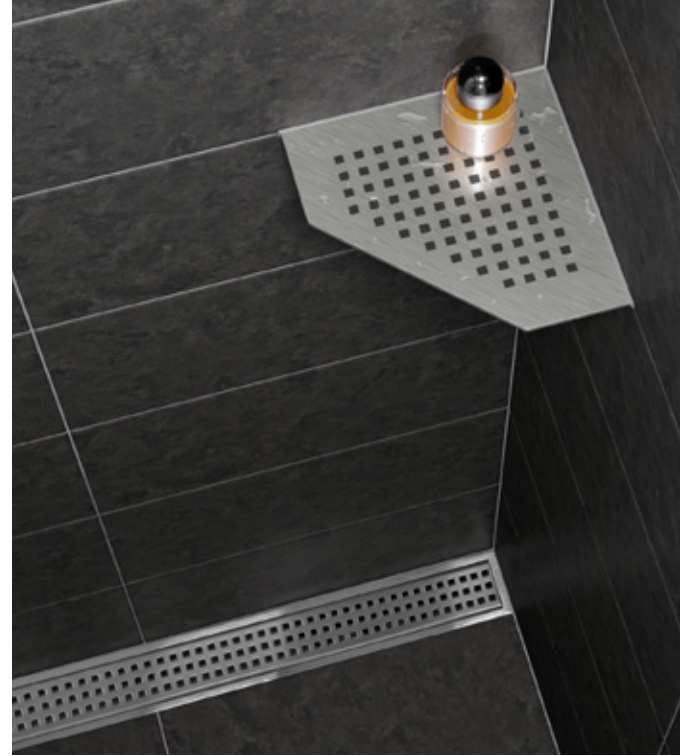

Schluter®-SHELF-E		
PURE		
Item No.	Finish	\$ / Unit
Stainless steel		
SES2 D7 EB	Brushed stainless steel (EB)	112.66
Color-coated aluminum		
SES2 D7 MBW	Matte white (MBW)	93.69
SES2 D7 TSI	▲ Ivory (TSI)	93.69
SES2 D7 TSBG	Greige (TSBG)	93.69
SES2 D7 TSC	Cream (TSC)	93.69
SES2 D7 TSOB	Bronze (TSOB)	93.69
SES2 D7 TSSG	Stone grey (TSSG)	93.69
SES2 D7 TSG	▲ Pewter (TSG)	93.69
SES2 D7 TSDA	▲ Dark anthracite (TSDA)	93.69
SES2 D7 MGS	Matte black (MGS)	93.69

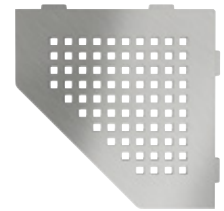

Schluter®-SHELF-E		
WAVE		
Item No.	Finish	\$ / Unit
Stainless steel		
SES2 D10 EB	Brushed stainless steel (EB)	117.40
Color-coated aluminum		
SES2 D10 MBW	Matte white (MBW)	100.79
SES2 D10 TSI	▲ Ivory (TSI)	100.79
SES2 D10 TSBG	Greige (TSBG)	100.79
SES2 D10 TSC	Cream (TSC)	100.79
SES2 D10 TSOB	Bronze (TSOB)	100.79
SES2 D10 TSSG	Stone grey (TSSG)	100.79
SES2 D10 TSG	▲ Pewter (TSG)	100.79
SES2 D10 TSDA	▲ Dark anthracite (TSDA)	100.79
SES2 D10 MGS	Matte black (MGS)	100.79

Schluter®-SHELF-E		
SQUARE		
Item No.	Finish	\$ / Unit
Stainless steel		
SES2 D3 EB	Brushed stainless steel (EB)	117.40
Color-coated aluminum		
SES2 D3 MBW	Matte white (MBW)	100.79
SES2 D3 TSI	▲ Ivory (TSI)	100.79
SES2 D3 TSBG	Greige (TSBG)	100.79
SES2 D3 TSC	Cream (TSC)	100.79
SES2 D3 TSOB	Bronze (TSOB)	100.79
SES2 D3 TSSG	Stone grey (TSSG)	100.79
SES2 D3 TSG	▲ Pewter (TSG)	100.79
SES2 D3 TSDA	▲ Dark anthracite (TSDA)	100.79
SES2 D3 MGS	Matte black (MGS)	100.79

Stainless steel

Color-coated aluminum



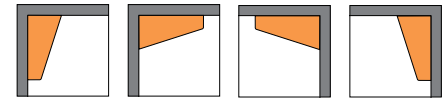
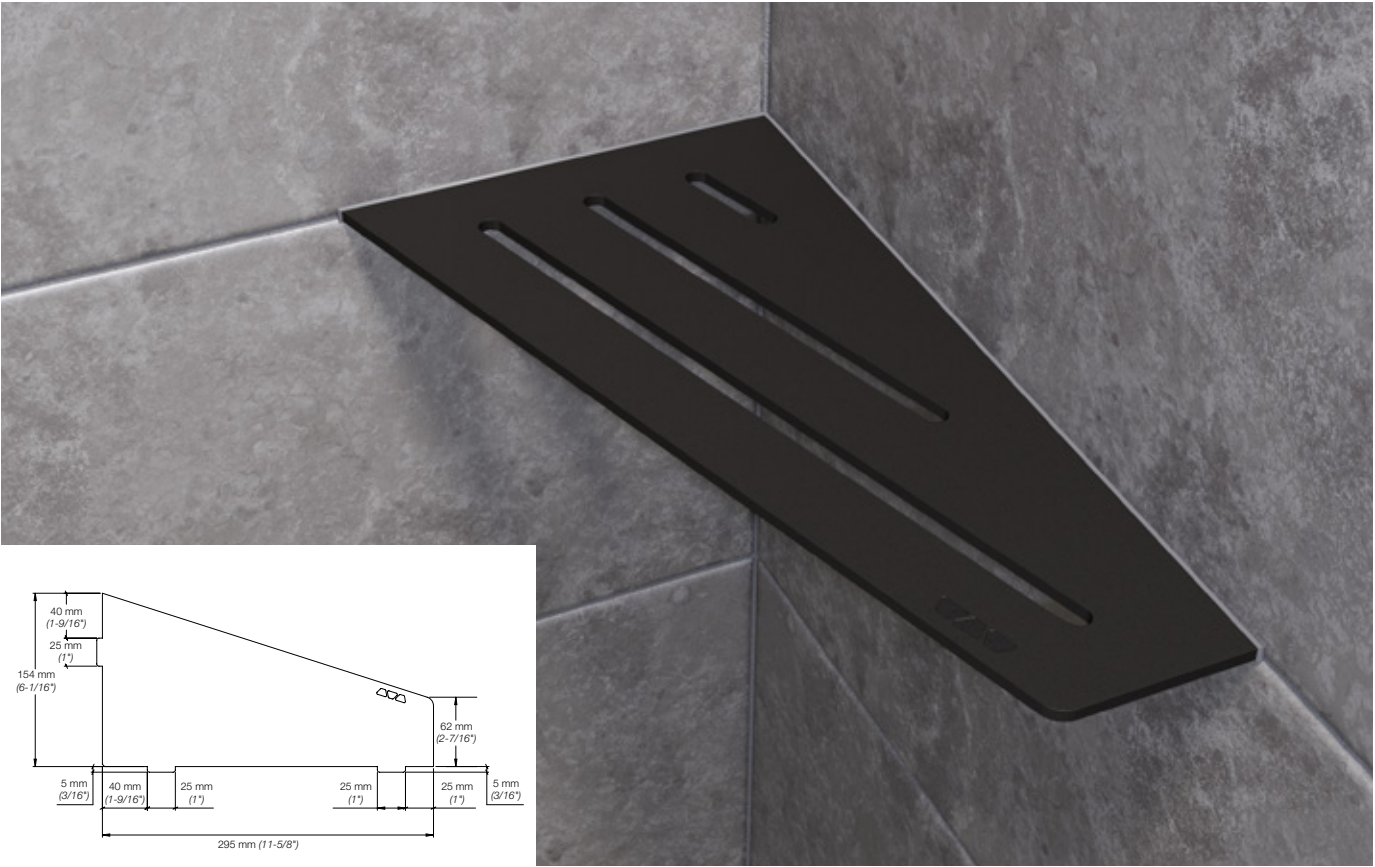

Quadrilateral Corner Shelf



Schluter®-SHELF-E		
FLORAL		
Item No.	Finish	\$ / Unit
Stainless steel		
SES3 D5 EB	Brushed stainless steel (EB)	152.97
Color-coated aluminum		
SES3 D5 MBW	Matte white (MBW)	117.40
SES3 D5 TSI	▲ Ivory (TSI)	117.40
SES3 D5 TSBG	Greige (TSBG)	117.40
SES3 D5 TSC	Cream (TSC)	117.40
SES3 D5 TSOB	Bronze (TSOB)	117.40
SES3 D5 TSSG	Stone grey (TSSG)	117.40
SES3 D5 TSG	▲ Pewter (TSG)	117.40
SES3 D5 TSDA	▲ Dark anthracite (TSDA)	117.40
SES3 D5 MGS	Matte black (MGS)	117.40

Schluter®-SHELF-E		
CURVE		
Item No.	Finish	\$ / Unit
Stainless steel		
SES3 D6 EB	Brushed stainless steel (EB)	152.97
Color-coated aluminum		
SES3 D6 MBW	Matte white (MBW)	105.53
SES3 D6 TSI	▲ Ivory (TSI)	105.53
SES3 D6 TSBG	Greige (TSBG)	105.53
SES3 D6 TSC	Cream (TSC)	105.53
SES3 D6 TSOB	Bronze (TSOB)	105.53
SES3 D6 TSSG	Stone grey (TSSG)	105.53
SES3 D6 TSG	▲ Pewter (TSG)	105.53
SES3 D6 TSDA	▲ Dark anthracite (TSDA)	105.53
SES3 D6 MGS	Matte black (MGS)	105.53



Schluter®-SHELF-E		
PURE		
Item No.	Finish	\$ / Unit
Stainless steel		
SES3 D7 EB	Brushed stainless steel (EB)	152.97
Color-coated aluminum		
SES3 D7 MBW	Matte white (MBW)	105.53
SES3 D7 TSI	▲ Ivory (TSI)	105.53
SES3 D7 TSBG	Greige (TSBG)	105.53
SES3 D7 TSC	Cream (TSC)	105.53
SES3 D7 TSOB	Bronze (TSOB)	105.53
SES3 D7 TSSG	Stone grey (TSSG)	105.53
SES3 D7 TSG	▲ Pewter (TSG)	105.53
SES3 D7 TSDA	▲ Dark anthracite (TSDA)	105.53
SES3 D7 MGS	Matte black (MGS)	105.53



Schluter®-SHELF-E		
WAVE		
Item No.	Finish	\$ / Unit
Stainless steel		
SES3 D10 EB	Brushed stainless steel (EB)	152.97
Color-coated aluminum		
SES3 D10 MBW	Matte white (MBW)	117.40
SES3 D10 TSI	▲ Ivory (TSI)	117.40
SES3 D10 TSBG	Greige (TSBG)	117.40
SES3 D10 TSC	Cream (TSC)	117.40
SES3 D10 TSOB	Bronze (TSOB)	117.40
SES3 D10 TSSG	Stone grey (TSSG)	117.40
SES3 D10 TSG	▲ Pewter (TSG)	117.40
SES3 D10 TSDA	▲ Dark anthracite (TSDA)	117.40
SES3 D10 MGS	Matte black (MGS)	117.40

Schluter®-SHELF-E		
SQUARE		
Item No.	Finish	\$ / Unit
Stainless steel		
SES3 D3 EB	Brushed stainless steel (EB)	152.97
Color-coated aluminum		
SES3 D3 MBW	Matte white (MBW)	117.40
SES3 D3 TSI	▲ Ivory (TSI)	117.40
SES3 D3 TSBG	Greige (TSBG)	117.40
SES3 D3 TSC	Cream (TSC)	117.40
SES3 D3 TSOB	Bronze (TSOB)	117.40
SES3 D3 TSSG	Stone grey (TSSG)	117.40
SES3 D3 TSG	▲ Pewter (TSG)	117.40
SES3 D3 TSDA	▲ Dark anthracite (TSDA)	117.40
SES3 D3 MGS	Matte black (MGS)	117.40

Stainless steel

Color-coated aluminum



▲ New product



Schluter®-SHELF-N

Schluter®-SHELF-N is a rectangular shelf designed to fit into Schluter®-KERDI-BOARD-SN prefabricated niches. The shelf is made of either brushed stainless steel, or color-coated aluminum in a choice of 9 TRENDLINE colors. SHELF-N can be easily installed in tandem with tile. Matching KERDI-DRAIN and KERDI-LINE grates are also available.

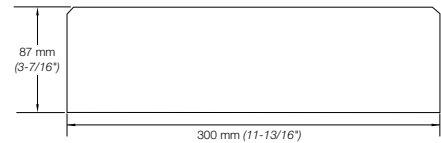
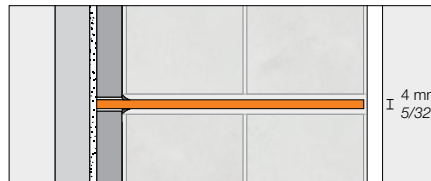

Schluter®-SHELF-N		
FLORAL		
Item No.	Finish	\$ / Unit
Stainless steel		
SNS1 D5 EB	Brushed stainless steel (EB)	130.43
Color-coated aluminum		
SNS1 D5 MBW	Matte white (MBW)	100.79
SNS1 D5 TSI	▲ Ivory (TSI)	100.79
SNS1 D5 TSBG	Greige (TSBG)	100.79
SNS1 D5 TSC	Cream (TSC)	100.79
SNS1 D5 TSOB	Bronze (TSOB)	100.79
SNS1 D5 TSSG	Stone grey (TSSG)	100.79
SNS1 D5 TSG	▲ Pewter (TSG)	100.79
SNS1 D5 TSDA	▲ Dark anthracite (TSDA)	100.79
SNS1 D5 MGS	Matte black (MGS)	100.79

Schluter®-SHELF-N		
CURVE		
Item No.	Finish	\$ / Unit
Stainless steel		
SNS1 D6 EB	Brushed stainless steel (EB)	124.51
Color-coated aluminum		
SNS1 D6 MBW	Matte white (MBW)	94.86
SNS1 D6 TSI	▲ Ivory (TSI)	94.86
SNS1 D6 TSBG	Greige (TSBG)	94.86
SNS1 D6 TSC	Cream (TSC)	94.86
SNS1 D6 TSOB	Bronze (TSOB)	94.86
SNS1 D6 TSSG	Stone grey (TSSG)	94.86
SNS1 D6 TSG	▲ Pewter (TSG)	94.86
SNS1 D6 TSDA	▲ Dark anthracite (TSDA)	94.86
SNS1 D6 MGS	Matte black (MGS)	94.86



Schluter®-SHELVE-N		
PURE		
Item No.	Finish	\$ / Unit
Stainless steel		
SNS1 D7 EB	Brushed stainless steel (EB)	124.51
Color-coated aluminum		
SNS1 D7 MBW	Matte white (MBW)	94.86
SNS1 D7 TSI	▲ Ivory (TSI)	94.86
SNS1 D7 TSBG	Greige (TSBG)	94.86
SNS1 D7 TSC	Cream (TSC)	94.86
SNS1 D7 TSOB	Bronze (TSOB)	94.86
SNS1 D7 TSSG	Stone grey (TSSG)	94.86
SNS1 D7 TSG	▲ Pewter (TSG)	94.86
SNS1 D7 TSDA	▲ Dark anthracite (TSDA)	94.86
SNS1 D7 MGS	Matte black (MGS)	94.86



Schluter®-SHELVE-N		
WAVE		
Item No.	Finish	\$ / Unit
Stainless steel		
SNS1 D10 EB	Brushed stainless steel (EB)	130.43
Color-coated aluminum		
SNS1 D10 MBW	Matte white (MBW)	100.79
SNS1 D10 TSI	▲ Ivory (TSI)	100.79
SNS1 D10 TSBG	Greige (TSBG)	100.79
SNS1 D10 TSC	Cream (TSC)	100.79
SNS1 D10 TSOB	Bronze (TSOB)	100.79
SNS1 D10 TSSG	Stone grey (TSSG)	100.79
SNS1 D10 TSG	▲ Pewter (TSG)	100.79
SNS1 D10 TSDA	▲ Dark anthracite (TSDA)	100.79
SNS1 D10 MGS	Matte black (MGS)	100.79



Schluter®-SHELVE-N		
SQUARE		
Item No.	Finish	\$ / Unit
Stainless steel		
SNS1 D3 EB	Brushed stainless steel (EB)	130.43
Color-coated aluminum		
SNS1 D3 MBW	Matte white (MBW)	100.79
SNS1 D3 TSI	▲ Ivory (TSI)	100.79
SNS1 D3 TSBG	Greige (TSBG)	100.79
SNS1 D3 TSC	Cream (TSC)	100.79
SNS1 D3 TSOB	Bronze (TSOB)	100.79
SNS1 D3 TSSG	Stone grey (TSSG)	100.79
SNS1 D3 TSG	▲ Pewter (TSG)	100.79
SNS1 D3 TSDA	▲ Dark anthracite (TSDA)	100.79
SNS1 D3 MGS	Matte black (MGS)	100.79

Stainless steel

Color-coated aluminum



▲ New product



Schluter®-SHOWERPROFILE-S

The **Schluter®-SHOWERPROFILE-S** is a two-part profile with a tapered edge, designed to cover adjoining tile edges that become exposed as the shower floor slopes to accommodate drainage to the Schluter®-KERDI-LINE. The tapered profile features a visible surface of brushed stainless steel and a fleece fabric on the reverse for bonding with the tile adhesive. It is designed to be inserted into the U-shaped groove of the matching hard PVC support profile. The profile can be used for lateral transitions to the wall or the adjoining floor.

Note: Tapered profiles with higher support profiles in the heights 9/16" (15 mm), 23/32" (18 mm), and 7/8" (22 mm) are available upon request for greater tile thicknesses. Please contact Customer Service for price and delivery times.

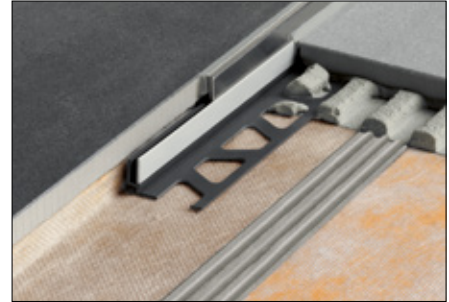
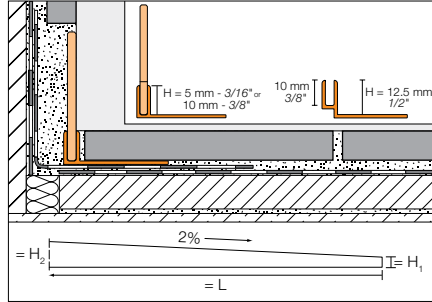

Schluter®-SHOWERPROFILE-SA				
Two-part tapered edging profile				
H = mm - in.	Item No.	H ₁ = mm - in.	H ₂ = mm - in.	\$ / Length
Length = 1.2 m - 47-1/4"				
5 - 3/16	SPSA 50 EB/120	6 - 1/4	30 - 1-3/16	76.09
Length = 1.6 m - 63"				
5 - 3/16	SPSA 50 EB/160	6 - 1/4	38 - 1-1/2	99.62
Length = 2 m - 78-3/4"				
5 - 3/16	SPSA 50 EB/200	6 - 1/4	46 - 1-13/16	221.77

Schluter®-SHOWERPROFILE-SB				
Two-part tapered edging profile				
H = mm - in.	Item No.	H ₁ = mm - in.	H ₂ = mm - in.	\$ / Length
Length = 1.2 m - 47-1/4"				
10 - 3/8	SPSB 100 EB/120	10 - 3/8	34 - 1-11/32	76.09
12.5 - 1/2	SPSB 125 EB/120	10 - 3/8	34 - 1-11/32	84.77
Length = 1.6 m - 63"				
10 - 3/8	SPSB 100 EB/160	10 - 3/8	42 - 1-21/32	99.62
12.5 - 1/2	SPSB 125 EB/160	10 - 3/8	42 - 1-21/32	110.34
Length = 2 m - 78-3/4"				
10 - 3/8	SPSB 100 EB/200	10 - 3/8	50 - 2	247.47
12.5 - 1/2	SPSB 125 EB/200	10 - 3/8	50 - 2	247.47

Schluter®-SHOWERPROFILE-R

The **Schluter®-SHOWERPROFILE-R** is a two part wall transition profile made of brushed stainless steel for covering the exposed wall area where the floor slopes down to a perimeter linear drain. A fleece fabric is laminated on the reverse of the profile for bonding with the tile adhesive. The two-part design of Schluter®-SHOWERPROFILE-R can be seamlessly adjusted to any height between 29/32" (23 mm) and 1-25/32" (45 mm) (available in two versions). The profile is available in lengths of 39" (1 m) and 55" (1.4 m) and can be cut to the desired length.

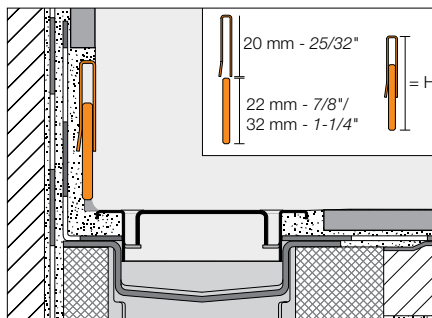

Schluter®-SHOWERPROFILE-R		
Two-part wall transition profile		
H = mm - in.	Item No.	\$ / Length
Length = 1 m - 39"		
23 - 35 - 29/32 - 1-3/8	SPRA 23 EB/100	92.58
33 - 45 - 1-5/16 - 1-25/32	SPRA 33 EB/100	100.89
Length = 1.4 m - 55"		
23 - 35 - 29/32 - 1-3/8	SPRA 23 EB/140	106.53
33 - 45 - 1-5/16 - 1-25/32	SPRA 33 EB/140	119.23



Schluter®-SHOWERPROFILE-WS

The **Schluter®-SHOWERPROFILE-WS** is a two-part profile that forms a splashguard at the entrance of barrier-free showers. The anodized aluminum support profile is set in conjunction with the tile covering and can be combined with either a semi-circular lip made of rigid PVC or a collapsible upright lip made of transparent polyurethane. Both variants allow for wheelchair accessibility.

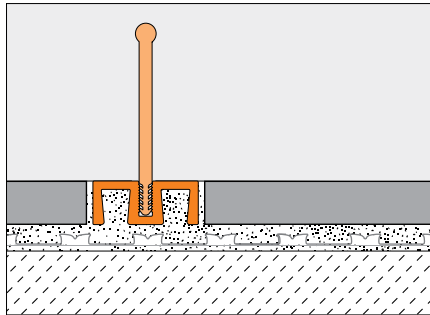

Schluter®-SHOWERPROFILE-WS		
Satin anodized aluminum support profile		
H = mm - in.	Item No.	\$ / Length
Length = 1 m - 39"		
8 - 5/16	SPWS 19 AE / 100	25.86
Length = 2.5 m - 8' 2-1/2"		
8 - 5/16	SPWS 19 AE	57.83

Schluter®-SHOWERPROFILE-WS		
Semi-circular lip		
H = mm - in.	Item No.	\$ / Length
Length = 1 m - 39"		
8 - 5/16	SPWSC 16 GS / 100	13.51
Length = 2.5 m - 8' 2-1/2"		
8 - 5/16	SPWSC 16 GS	29.71

Schluter®-SHOWERPROFILE-WSL		
Straight lip		
H = mm - in.	Item No.	\$ / Length
Length = 1 m - 39"		
8 - 5/16	SPWSL 30 T / 100	16.32
Length = 2.5 m - 8' 2-1/2"		
8 - 5/16	SPWSL 30 T	35.90

ADA-Compliant

Note: SHOWERPROFILE-WS with the WSL straight lip insert is not ADA-compliant.

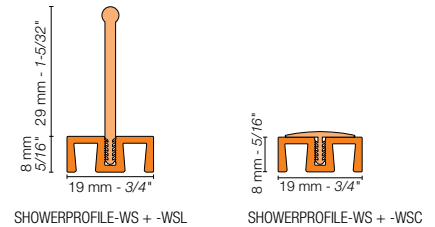

Schluter®-SHOWERPROFILE-WSK

The **Schluter®-SHOWERPROFILE-WSK** is a two-part profile that forms a splashguard at the entrance of barrier-free showers. The anodized aluminum support profile is adhered to existing coverings and can be combined with either a semi-circular lip made of rigid PVC or a collapsible upright lip made of transparent polyurethane. Both variants allow for wheelchair accessibility.

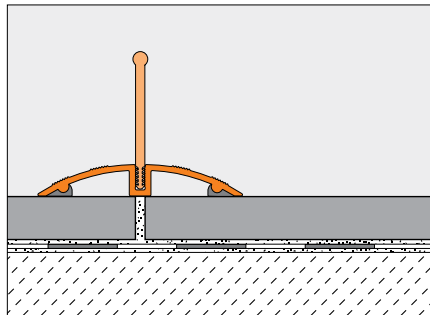

Schluter®-SHOWERPROFILE-WSK		
Satin anodized aluminum support profile		
H = mm - in.	Item No.	\$ / Length
Length = 1 m - 39"		
8 - 5/16	SPWSK 52 AE / 100	30.34
Length = 2.5 m - 8' 2-1/2"		
8 - 5/16	SPWSK 52 AE	69.19

Schluter®-SHOWERPROFILE-WSK		
Semi-circular lip		
H = mm - in.	Item No.	\$ / Length
Length = 1 m - 39"		
8 - 5/16	SPWSC 16 GS / 100	13.51
Length = 2.5 m - 8' 2-1/2"		
8 - 5/16	SPWSC 16 GS	29.71

Schluter®-SHOWERPROFILE-WSL		
Straight lip		
H = mm - in.	Item No.	\$ / Length
Length = 1 m - 39"		
8 - 5/16	SPWSL 30 T / 100	16.32
Length = 2.5 m - 8' 2-1/2"		
8 - 5/16	SPWSL 30 T	35.90

Schluter®-SHOWERPROFILE-WSK-EK		
End cap		
H = mm - in.	Item No.	\$ / Unit
8 - 5/16	EK / SPWSK 52 AE	5.55

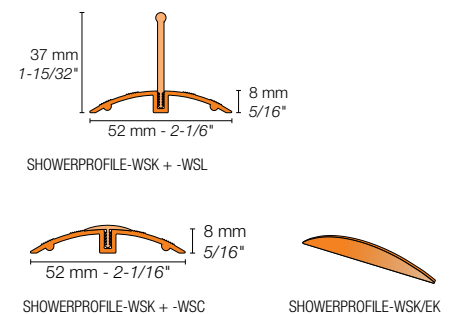

ADA-Compliant

Note: SHOWERPROFILE-WSK with the WSL straight lip insert is not ADA-compliant.

Schluter®-DECO-SG

Schluter®-DECO-SG is a decorative profile featuring a 1/2" (12.5 mm) or 9/16" (15 mm) -wide channel that creates a shadow gap between tile courses or other wall covering. The profile may also be used as a support channel for glass panels. The 1/2" (12.5 mm) wide channel accommodates glass panels up to a thickness of 3/8" (10 mm), and the 9/16" (15 mm) wide channel accommodates glass panels up to a thickness of 1/2" (12.5 mm). DECO-SG features a trapezoid-perforated anchoring leg that is secured in the bond coat beneath the tile.

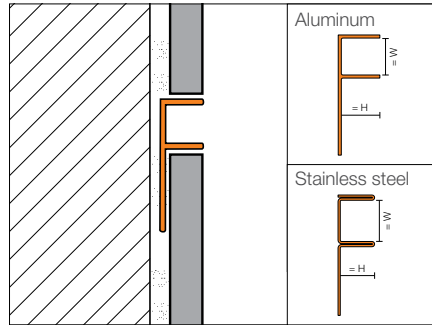

Schluter®-DECO-SG						
Length = 2.5 m - 8' 2-1/2"	Brushed stainless steel 304 (1.4301 = V2A) (EB)		Satin anodized aluminum (AE)		Bright chrome anodized aluminum (ACB)	
H = mm - in.	Item No.	\$ / Length	Item No.	\$ / Length	Item No.	\$ / Length
W: 12.5 mm - 1/2"						
8 - 5/16	SG 80 EB 12	79.98	SG 80 AE 12	22.09	SG 80 ACB 12	22.98
10 - 3/8	SG 100 EB 12	85.42	SG 100 AE 12	23.23	SG 100 ACB 12	24.06
11 - 7/16	SG 110 EB 12	88.36	SG 110 AE 12	23.86	SG 110 ACB 12	24.75
12.5 - 1/2	SG 125 EB 12	93.04	SG 125 AE 12	24.67	SG 125 ACB 12	25.56
W: 15 mm - 9/16"						
8 - 5/16	SG 80 EB 15	82.47	SG 80 AE 15	23.19	SG 80 ACB 15	24.12
10 - 3/8	SG 100 EB 15	87.85	SG 100 AE 15	24.40	SG 100 ACB 15	25.27
11 - 7/16	SG 110 EB 15	91.13	SG 110 AE 15	25.05	SG 110 ACB 15	25.99
12.5 - 1/2	SG 125 EB 15	94.59	SG 125 AE 15	25.91	SG 125 ACB 15	26.86

NEW! Schluter®-TRENDLINE Textured Color-coated Aluminum

Length = 2.5 m - 8' 2-1/2"	▲ Textured color-coated aluminum	
H = mm - in.	Item No.	\$ / Length
W: 12.5 mm - 1/2"		
8 - 5/16	SG 80 + color* 12	42.94
10 - 3/8	SG 100 + color* 12	44.10
11 - 7/16	SG 110 + color* 12	44.71
12.5 - 1/2	SG 125 + color* 12	45.14
W: 15 mm - 9/16"		
8 - 5/16	SG 80 + color* 15	44.99
10 - 3/8	SG 100 + color* 15	46.15
11 - 7/16	SG 110 + color* 15	46.76
12.5 - 1/2	SG 125 + color* 15	47.19

***Color Codes**

Ivory	Greige	Stone grey	Cream	Bronze	Pewter	Dark anthracite	Matte white	Matte black

* To complete the item number, add the color code (e.g., SG 80 TSI 12).



Schluter®-DECO-SGC

Schluter®-DECO-SGC is a decorative profile featuring a 1/2" (12.5 mm) or 9/16" (15 mm) -wide channel used as a vertical support for glass panels in recessed showers that border on untiled walls that are plastered, creating a 90° angle between the glass partition and the untiled wall. The 1/2" (12.5 mm) wide channel accommodates glass panels up to a thickness of 3/8" (10 mm), and the 9/16" (15 mm) wide channel accommodates glass panels up to a thickness of 1/2" (12.5 mm). DECO-SGC features a trapezoid-perforated anchoring leg that is secured in the bond coat beneath the tile.

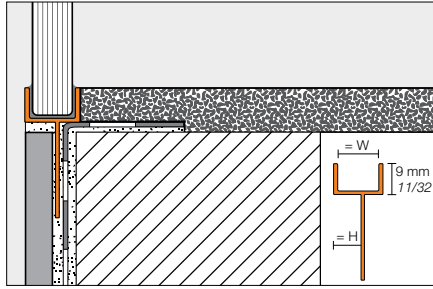

Schluter®-DECO-SGC			
Length = 2.5 m - 8' 2-1/2"	Satin anodized aluminum (AE)		
H = mm - in.	Item No.	\$/ Length	
W: 12.5 mm - 1/2"			
8 - 5/16	SGC 80 AE 12	23.86	
10 - 3/8	SGC 100 AE 12	25.09	
11 - 7/16	SGC 110 AE 12	25.77	
12.5 - 1/2	SGC 125 AE 12	26.65	
W: 15 mm - 9/16"			
8 - 5/16	SGC 80 AE 15	25.04	
10 - 3/8	SGC 100 AE 15	26.35	
11 - 7/16	SGC 110 AE 15	27.05	
12.5 - 1/2	SGC 125 AE 15	27.99	

Schluter®-KERDI-FIX

Schluter®-KERDI-FIX is a single-component sealing and bonding compound with a silane-modified polymer base. It is odor-neutral, UV- and weather-resistant, and contains no solvents. KERDI-FIX is elastomeric and bonds well to most materials, such as wood, stone, concrete, metal, glass, and many plastics. KERDI-FIX is suitable for bonding and Schluter®-KERDI waterproofing membrane and Schluter®-KERDI-BAND to fixed building elements. KERDI-FIX is also suitable for use as a sealant.



*Color Codes
<div style="display: flex; justify-content: space-around; align-items: center;"> <div style="text-align: center;"> <p>BW Bright white</p> </div> <div style="text-align: center;"> <p>G Grey</p> </div> </div>

Schluter®-KERDI-FIX	
Cartridge (290 ml – 9.81 fl oz)	
Item No.	\$/ Unit
KERDIFIX / + color*	30.49

Schluter®-KERDI-FIX	
Tube (100 ml – 3.38 fl oz) - Grey (G)	
Item No.	\$/ Unit
KERDIFIX 100 G	17.71

⚠ WARNING: Reproductive Harm - www.P65Warnings.ca.gov



Schluter®-BEKOTEC

Modular screed system for conventional & radiant-heated screeds

BEKOTEC is a modular screed system that produces permanent flooring assemblies that are free from internal stresses. The BEKOTEC system is based on a studded polystyrene screed panel. The studs confine curing stresses to small modules, which eliminates curling and allows the installation of continuous screed surfaces without any wire reinforcement or control joints. BEKOTEC is ideal for hydronic radiant heating applications, as it provides thermal insulation, allows for hydronic radiant tube application without fasteners, and reduces thermal mass to produce a responsive system that can operate at a low temperature range. The BEKOTEC system can also be used in conjunction with common sound insulation materials to produce a flooring system with excellent sound attenuation properties.





Schluter®-BEKOTEC and Schluter®-BEKOTEC-F

The **Schluter®-BEKOTEC** family of products are lightweight modular screed systems that are used to create continuous screed surfaces without control joints or reinforcement and can also accommodate hydronic radiant heating tubes 3/8"-5/8" (10-16 mm) O.D. They produce permanent flooring assemblies that are free from internal stresses by confining the shrinkage and curing stresses to smaller modules, which controls deformations such as curling and continuous cracks that are common in traditional screeds. Since they are floating systems, the assemblies can be customized to meet a range of heat and sound requirements. For use with ceramic tile, natural stone, or other surface coverings.

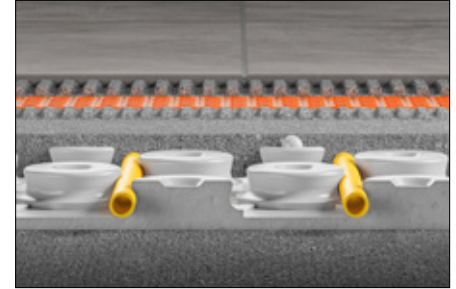
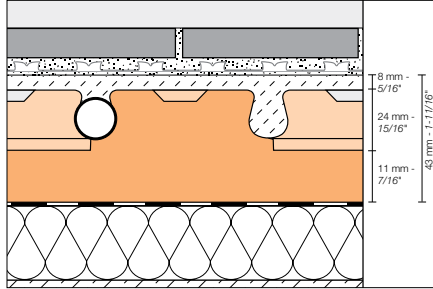

Schluter®-BEKOTEC			
Studded screed panel			35 mm - 1-3/8"
Item No.	Dimensions/Sheet	Packaging	\$ / Box
EN/US/P	61 x 122 cm = 0.74 m ² - 24" x 48" = 8 ft ²	12 sheets / box	240.95

Schluter®-BEKOTEC is 1-3/8" (35 mm) -thick, and is made of expanded polystyrene.

Schluter®-BEKOTEC-F is 29/32" (23 mm) -thick, and is made of polystyrene foil.

EN/US/P = Screed panel

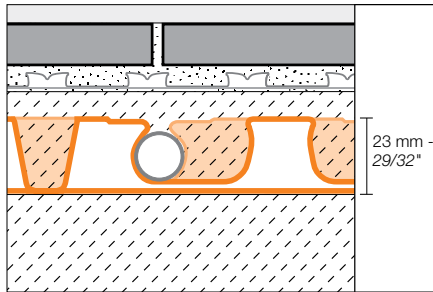
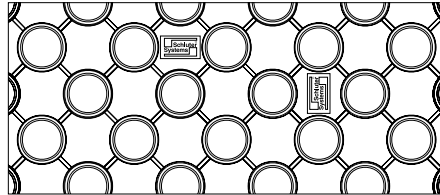

Schluter®-BEKOTEC-F			
Studded screed panel			23 mm - 29/32"
Item No.	Dimensions/Sheet	Packaging	\$ / Box
EN23F10	120 x 90 cm = 1.08 m ² 47-1/4" x 35-7/16" = 11.63 ft ²	10 sheets / box	373.49



BRS



BRSK



BRS/KF



BRS/KSF



Schluter®-BEKOTEC-BRS

Edge strip for conventional screed

Item No.	Dimensions	\$ / Roll
BRS 810	50 m roll: 10 cm wide x 8 mm thick 164' roll: 4" wide x 5/16" thick	89.63

Schluter®-BEKOTEC-BRSK

Edge strip for conventional screed, with adhesive strip

Item No.	Dimensions	\$ / Roll
BRSK 810	50 m roll: 10 cm wide x 8 mm thick 164' roll: 4" wide x 5/16" thick	116.51

Schluter®-BEKOTEC-BRS/KF

Edge strip for poured screeds, with PE-adhesive leg

Item No.	Dimensions	\$ / Roll
BRS 808 KF	25 m roll: 8 cm wide x 8 mm thick 82' roll: 3-1/8" wide x 5/16" thick	169.26

Schluter®-BEKOTEC-BRS/KSF

Self-supporting edge strip for poured screed, with PE-adhesive leg

Item No.	Dimensions	\$ / Roll
BRS 808 KSF	25 m roll: 8 cm wide x 8 mm thick 82' roll: 3-1/8" wide x 5/16" thick	228.52

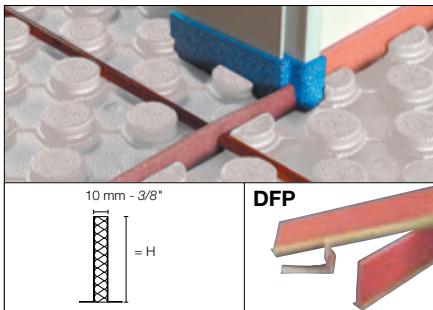

Schluter®-DILEX-DFP

Length = 1 m - 3' 3" Movement joint profile for installation at door areas or for dividing screed surfaces

H = mm - in.	Item No.	\$ / Length
60 - 2-3/8	DFP 6/100	17.27
80 - 3-1/8	DFP 8/100	20.72
100 - 4	DFP 10/100	24.15

Schluter®-BEKOTEC-THERM-RH 75

Schluter®-BEKOTEC-THERM-RH 75 is a PVC clamp used to attach radiant heating tubes to the BEKOTEC-EN/US/P (1-3/8" - 35 mm)-thick panels. While the studs on the BEKOTEC panel are designed to hold the tubes in place, the clamp is especially useful for forming 45° angles with heating tubes in the studded panel.



Schluter®-BEKOTEC-THERM-RH 75

Heating Clamps

Item No.	Quantity	\$ / pkg
BTZRH75/100	100 units / pkg	72.08



Schluter® Setting Materials

Premium quality thin-set mortars & primer

Schluter Systems' thin-set mortars are specifically formulated for use with Schluter membranes and boards. Unmodified, modified, and rapid-setting versions are available. All are sag-resistant, smooth and creamy, easy to handle and spread, and suitable for use with ceramic, porcelain, and stone tile, including large and heavy tile, in conjunction with Schluter Systems' uncoupling and waterproofing membranes (e.g., DITRA, DITRA-HEAT, and KERDI), the Schluter Shower System, and KERDI-BOARD.

PRIMER-U is a ready-to-use universal primer used to enhance adhesion of mortars for hard-to-bond substrates such as gypsum underlayment, existing tile, terrazzo, steel (e.g. raised access panels), flooring adhesive residue, concrete with curing compounds, latex paint, and glass tile.



Schluter®-SET

Schluter®-SET is a premium unmodified thin-set mortar specifically formulated for use with Schluter® membranes and boards. It is sag-resistant, smooth and creamy, and easy to handle and spread. Schluter®-SET is suitable for use with ceramic, porcelain, and stone tile, including large and heavy tile, in conjunction with Schluter®-Systems' uncoupling and waterproofing membranes (e.g., DITRA, DITRA-HEAT, and KERDI), the Schluter®-Shower System, and Schluter®-KERDI-BOARD.

Schluter®-SET meets the requirements of ANSI A118.1, and is available in both grey and white.



Schluter®-SET			
Premium unmodified mortar			
Item No.	Color	Weight	\$
SET50G	Grey	22.7 kg - 50 lbs	Please contact your local Schluter supplier for pricing.
SET50W	White	22.7 kg - 50 lbs	

WARNING: Cancer and Reproductive Harm – www.P65Warnings.ca.gov

Schluter®-ALL-SET

Schluter®-ALL-SET is a specialized modified thin-set mortar specifically formulated for use with Schluter® membranes and boards. It is engineered for use both under and over all DITRA and KERDI products. It is sag-resistant, smooth and creamy, and easy to handle and spread. ALL-SET is suitable for use with ceramic, porcelain, and stone tile, including large and heavy tile, in conjunction with Schluter®-Systems' uncoupling and waterproofing membranes (e.g., DITRA, DITRA-HEAT, and KERDI), the Schluter®-Shower System, and Schluter®-KERDI-BOARD.

ALL-SET meets the requirements of ANSI A118.4, A118.11, and A118.15, and is available in both grey and white.



Schluter®-ALL-SET			
Specialized modified mortar			
Item No.	Color	Weight	\$
SETA50G	Grey	22.7 kg - 50 lbs	Please contact your local Schluter supplier for pricing.
SETA50W	White	22.7 kg - 50 lbs	

WARNING: Cancer and Reproductive Harm – www.P65Warnings.ca.gov

Schluter®-FAST-SET

Schluter®-FAST-SET is a specialized rapid-setting modified thin-set mortar specifically formulated for use with Schluter® membranes and boards. It is engineered for use both under and over all DITRA and KERDI products. FAST-SET is ready to grout in 4 hours for fast-track projects. It is sag-resistant, smooth and creamy, and easy to handle and spread. FAST-SET is suitable for use with ceramic, porcelain, and stone tile, including large and heavy tile, in conjunction with Schluter®-Systems' uncoupling and waterproofing membranes (e.g., DITRA, DITRA-HEAT, and KERDI), the Schluter®-Shower System, and Schluter®-KERDI-BOARD.

FAST-SET meets the requirements of ANSI A118.4TF, A118.11, and A118.15TF, and is available in both grey and white.



Schluter®-FAST-SET			
Specialized rapid-setting mortar			
Item No.	Color	Weight	\$
SETF50G	Grey	22.7 kg - 50 lbs	Please contact your local Schluter supplier for pricing.
SETF50W	White	22.7 kg - 50 lbs	

WARNING: Cancer and Reproductive Harm – www.P65Warnings.ca.gov



Quantity per pallet is 56 bags. Minimum order is 4 pallets.
Special freight conditions apply, please see Conditions of Sale on pages 199 - 200 for details.
Bundle offers for thin-set pallets with other products (i.e. DITRA and KERDI) are available, and are eligible for free shipping.
Please consult a Schluter Sales Representative for more details.



Suitable Uses

Schluter®-DITRA and DITRA-HEAT over	Schluter®-SET	Schluter®-ALL-SET	Schluter®-FAST-SET
Plywood/OSB	X	✓	✓
Concrete	✓	✓	✓
Gypsum	✓	✓	✓
Vinyl flooring	X	X	✓
Schluter®-KERDI over			
Gypsum board	✓	✓	✓
Cement backerboard	✓	✓	✓
Fiber-cement board	✓	✓	✓
Portland cement mortar	✓	✓	✓
KERDI-SHOWER prefabricated substrates	✓	✓	✓
TILE over DITRA, DITRA-HEAT, KERDI and KERDI-BOARD			
Ceramic	✓	✓	✓
Porcelain	✓	✓	✓
Natural stone (e.g., granite, marble, etc.)	✓	✓	✓

- For Schluter®-Systems applications, refer to the Schluter®-DITRA, Schluter®-DITRA-HEAT, and Schluter®-Shower System Installation Handbooks.
- For other applications, refer to TCNA Handbook for Ceramic, Glass, and Stone Tile Installation and TTMAC Specification Guide 09 30 00 Tile Installation Manual.
- Contact Schluter®-Systems Technical Services for installation of glass tile, resin-backed tile, and/or moisture sensitive stone.

✓ = Approved use X = Not recommended

Coverage

Membrane-to-substrate		
Schluter®-DITRA-TROWEL 4.5 mm x 4.5 mm - 11/64" x 11/64"	Schluter®-DITRA-HEAT/-XL-TROWEL 6 mm x 6 mm - 1/4" x 1/4"	Schluter®-KERDI-TROWEL 3 mm x 3 mm - 1/8" x 1/8"
13.9 m ² - 150 ft ²	9.3 m ² - 100 ft ²	18.6 m ² - 200 ft ²

Tile-to-membrane			
Trowel	Schluter®-DITRA/DITRA-HEAT	Schluter®-DITRA-XL	Schluter®-KERDI/KERDI-BOARD
6 mm x 6 mm - 1/4" x 1/4"	5.6 - 6.5 m ² - 60 - 70 ft ²	4.2 - 5.1 m ² - 45 - 55 ft ²	8.4 - 9.3 m ² - 90 - 100 ft ²
6 mm x 9.5 mm - 1/4" x 3/8"	3.7 - 4.6 m ² - 40 - 50 ft ²	3.3 - 4.2 m ² - 35 - 45 ft ²	5.1 - 6.0 m ² - 55 - 65 ft ²
12.5 mm x 12.5 mm - 1/2" x 1/2"	2.8 - 3.7 m ² - 30 - 40 ft ²	2.3 - 3.3 m ² - 25 - 35 ft ²	3.7 - 4.6 m ² - 40 - 50 ft ²
19 mm - 3/4"	2.3 - 3.3 m ² - 25 - 35 ft ²	1.9 - 2.8 m ² - 20 - 30 ft ²	2.8 - 3.7 m ² - 30 - 40 ft ²

Values are approximate

Schluter®-PRIMER-U

Schluter®-PRIMER-U is a ready-to-use, one-component, solvent-free, 100% acrylic, water-based, universal primer. It is used to enhance adhesion properties when applying Schluter thin-set mortars to difficult-to-bond-to surfaces such as gypsum underlayment, raised access panels, and existing tile. PRIMER-U is suitable for use with Schluter SET, ALL-SET, and FAST-SET thin-set mortars, as well as DITRA-HEAT-PS and DITRA-HEAT-DUO-PS peel and stick membranes in interior applications where increased adhesion is required over various porous and non-porous substrates. PRIMER-U is freeze/thaw stable.

PRIMER-U was evaluated according to Rule 1168 from the South Coast Air Quality Management District and found to comply with the VOC requirements.

Suitable Substrates:

- Gypsum underlayment
- Concrete
- Existing tile
- Glass tile
- Plywood and OSB
- Terrazzo
- Steel
- VCT flooring
- Well-bonded flooring adhesive residue
- Latex paint
- Epoxy
- Aluminum
- Resin-backed mosaic tiles
- Asphalt-based cutback adhesive

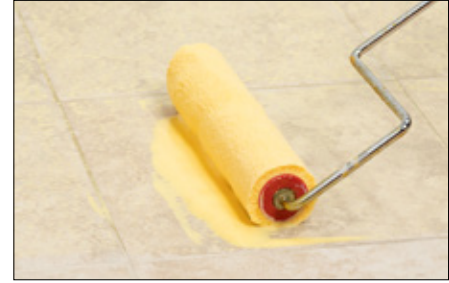

Schluter®-PRIMER-U

Universal primer

Item No.	Quantity	Coverage	\$ / Unit
▲ PRMUQT1	946 ml – 1 Qt.	5 - 12.5 m ² – 50 - 135 ft ²	26.69
PRMU1	3.78 L – 1 Gal.	23 - 51 m ² – 250 - 550 ft ²	73.39
PRMU5	18.9 L – 5 Gal.	116 - 255 m ² – 1250 - 2750 ft ²	293.58

▲ WARNING: Cancer and Reproductive Harm – www.P65Warnings.ca.gov



The case quantity of the 1 gallon (3.78 L) format of PRIMER-U (PRMU1) is 4 units.
The case quantity of the 1 quart (946 ml) format of PRIMER-U (PRMUQT1) is 12 units.



Schluter®-TROWEL

The **Schluter®-DITRA-TROWEL**, **KERDI-TROWEL**, and **DITRA-HEAT/-DITRA-XL-TROWEL** feature square-notched designs to effectively install DITRA, KERDI, DITRA-XL, DITRA-HEAT, and DITRA-HEAT-DUO, respectively.

DITRA-TROWEL features a 11/64" x 11/64" (4.5 mm x 4.5 mm) square notch.

KERDI-TROWEL features a 1/8" x 1/8" (3 mm x 3 mm) square notch.

DITRA-HEAT/-DITRA-XL-TROWEL features a 1/4" x 1/4" (6 mm x 6 mm) square notch.

All Schluter® Trowels are made of uncoated stainless steel, making them even more durable.



Schluter®-TROWEL		
Item No.	Notch Size	\$ / Unit
KERDI		
TRL-KER	3 mm x 3 mm - 1/8" x 1/8"	34.15
DITRA		
TRL-DIT	4.5 mm x 4.5 mm - 11/64" x 11/64"	34.15
DITRA-HEAT/-DITRA-XL		
TRL-DHXL	6 mm x 6 mm - 1/4" x 1/4"	34.15

Schluter®-DITRA-ROLLER

Schluter®-DITRA-ROLLER is used to embed DITRA and DITRA-HEAT membranes in the bond coat during installation. The lightweight DITRA-ROLLER features a 14-1/2" (37 cm) wide roller and a shelf for placing 50 to 75 lbs of weight (e.g., bag of thin-set mortar or grout, box of tiles, etc.). Between uses, it can be conveniently disassembled for transport and storage.



Schluter®-DITRA-ROLLER	
Item No.	\$ / Unit
DIRO	264.39



Schluter®-SNIPS

Schluter®-SNIPS are specifically designed to cut PVC trim profiles.



Schluter®-SNIPS	
Item No.	\$ / Unit
PSF	91.27
Replacement blade	
PS 90/45 EK	27.93

Schluter®-PROCUT-TSM

Schluter®-PROCUT-TSM is a cutting wheel with a diameter of 4-1/2" (115 mm) for conventional angle grinders. It produces especially clean cuts of stainless steel, aluminum, and brass.

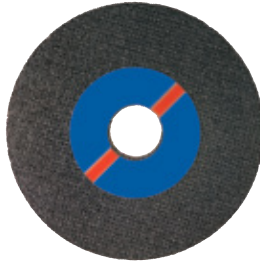

Schluter®-PROCUT-TSM	
Item No.	\$ / Unit
TSM 115/1	14.72



Schluter®-Systems Tools 2-Year Limited Warranty

COVERAGE AND CONDITIONS: Subject to the conditions and limitations as stated hereinafter, Schluter®-Systems* warrants that Schluter®-Systems Tools (the "Products")** will be free from manufacturing defects in materials and workmanship for a period of two (2) years from the date of purchase only when the Products have been used for their intended purpose in accordance with the Schluter®-Systems Illustrated Price List. Abnormal use, including but not limited to, misuse, accident, modification, unreasonable use, abuse, neglect, lack of maintenance, or use after the product is significantly worn, is not covered by this warranty. Consumable Products or consumable parts of Products are warranted, at the time of sale, only against defects in workmanship or materials that prevent their use. Consumable products or parts are goods reasonably expected to be used up or damaged during normal use, including but not limited to trowels, cutting blades, and cutting wheels. This warranty does not cover normal wear and tear or defects revealed by normal wear and tear.

RESOLUTION: If the Products fail to meet this warranty, then the owner's exclusive remedy and the sole obligation of Schluter®-Systems, at its election, shall be to a) repair or replace the failed Products or b) pay an amount not to exceed the original cost of the Products verified to be defective.

DISCLAIMER: THERE ARE NO WARRANTIES BEYOND THIS EXPRESSED WARRANTY AS STATED ABOVE. ALL OTHER WARRANTIES, REPRESENTATIONS OR CONDITIONS, EXPRESSED OR IMPLIED, ARE DISCLAIMED AND EXCLUDED, INCLUDING WARRANTIES, REPRESENTATIONS OR CONDITIONS OF **MERCHANTABILITY** OR FITNESS FOR A PARTICULAR PURPOSE ARISING BY STATUTE OR OTHERWISE BY LAW OR FROM A COURSE OF DEALING OR USAGE OF TRADE. SCHLUTER®-SYSTEMS EXCLUDES AND IN NO EVENT SHALL HAVE ANY LIABILITY FOR LOST PROFITS OR ANY OTHER INDIRECT, SPECIAL, INCIDENTAL, PUNITIVE, EXEMPLARY, OR CONSEQUENTIAL DAMAGES, ARISING OUT OF OR OTHERWISE CONNECTED TO FAILURE OF THE PRODUCTS, NOR MISUSE OF THE PRODUCTS, REGARDLESS OF ANY STRICT LIABILITY, ACTIVE OR PASSIVE NEGLIGENCE OF SCHLUTER®-SYSTEMS, AND REGARDLESS OF THE LEGAL THEORY (CONTRACT OR TORT OR EXTRA-CONTRACTUAL OR OTHER), NOR FROM ACTS OF WAR, TERRORISM, FIRES, EXPLOSIONS, ACTS OF GOD, INTENTIONAL ACTS OF DESTRUCTION OR ANY LOSSES DUE TO CAUSES UNRELATED TO THE PRODUCT OR DELAYS, OR ANY OTHER INCIDENTAL OR CONSEQUENTIAL DAMAGES. THIS WARRANTY IS GIVEN IN LIEU OF ANY OTHER WARRANTY EXPRESSED OR IMPLIED. THE REMEDIES CONTAINED HEREIN ARE THE ONLY REMEDIES AVAILABLE FOR BREACH OF THIS WARRANTY. THIS LIMITED WARRANTY GIVES YOU SPECIFIC LEGAL RIGHTS, SOME STATES AND PROVINCES DO NOT ALLOW DISCLAIMERS OR OTHER RESTRICTIONS OF IMPLIED WARRANTIES SO SOME OF THE ABOVE LIMITATIONS MAY NOT APPLY TO YOU.

TRANSFERRABILITY: This Limited Warranty extends ONLY to the original intended owner (defined as original purchaser of the tool – herein after referred to as "Owner") and is not transferable or assignable, unless otherwise prohibited by specific state or provincial law.

MODIFICATIONS TO WARRANTY: No changes or modification of any terms or conditions of this warranty are allowed unless authorized by written agreement and signed by the Technical Director or an Officer of Schluter®-Systems.

EFFECTIVE DATE: This warranty shall supersede and replace any and all prior oral or written warranties, agreements, or other such representations made by or on behalf of Schluter®-Systems relative to the Products or the use of the Products and shall apply to any purchase occurring on or after January 1, 2013.

CLAIMS ON THIS LIMITED WARRANTY: To make a claim under this Limited Warranty, the owner must provide Schluter®-Systems with written notice within 30 days of any alleged defect in the Products covered by this Limited Warranty, together with date and proof of purchase of the Products, failing which this Limited Warranty shall be of no legal effect. Schluter®-Systems reserves the right at its election and as a condition of this Limited Warranty to inspect the alleged failed and defective condition.

All U.S. Claims shall be sent to:

Schluter Systems L.P.
Attn: Warranty Claims Dept.
194 Pleasant Ridge Road
Plattsburgh, NY 12901-5841

All Canadian Claims shall be sent to:

Schluter Systems (Canada), Inc.
Attn: Warranty Claims Dept.
21100 ch. Ste-Marie
Ste-Anne-de-Bellevue, QC H9X 3Y8

*For the purpose of this warranty Schluter Systems, L.P. shall provide the warranty for all products for end users located in the United States, and SchluterSystems (Canada) Inc. shall provide the warranty for all products for end users located in Canada. This warranty is limited to sales of the products made in and intended for use in the United States and Canada.

**Schluter®-Systems Tools (the "Products"): The products are defined to include all Schluter®-Systems tools referred to in the Schluter®-Systems Illustrated Price List.

Material Properties and Areas of Application

Schluter® profiles are resistant to most chemicals encountered in tiled environments. In special cases, the suitability of a proposed type of material must be verified based on the anticipated chemical, mechanical, and/or other stresses. Exceptions and special considerations are listed below.

Stainless steel profiles are roll-formed, resulting in a slightly different contour from those made of extruded brass or aluminum. Stainless steel can sustain high mechanical stresses and is particularly well suited for applications requiring resistance against chemicals and acids; for example in the food industry, breweries, dairies, commercial kitchens, and hospitals, as well as in residential applications. Typically, the profiles are formed using stainless steel 304 (1.4301 = V2A). For more severe chemical exposure, such as de-icing salts and chemicals used in swimming pools, we recommend the use of stainless steel 316 L (1.4404 = V4A), which offers even higher corrosion resistance than the 304. Even stainless steel cannot withstand all chemical exposures, such as hydrochloric acid, hydrofluoric acid or certain chlorine, chloride and brine concentrations.

Solid brass sustains high levels of mechanical stress; for example, as edge protection for outside wall corners or edges of surface coverings. Brass is resistant to most chemicals used in tiled environments. Solid brass that is

exposed to air will oxidize, resulting in a natural patina. If exposed to moisture or aggressive substances, heavy oxidation and spotting may occur.

Chrome-plated brass is especially suited for wall corners and finishing applications. It is ideal for matching chrome fixtures. Surface areas must be protected against abrasion or scratching.

Aluminum profiles must be tested to verify their suitability if chemical stresses are anticipated. Cementitious materials, in conjunction with moisture, become alkaline. Since aluminum is sensitive to alkaline substances, exposure to the alkali (depending on the concentration and duration of exposure) may result in corrosion (aluminum hydroxide formation). Therefore, it is important to remove mortar or grout residue from visible surfaces. In addition, ensure that the profile is solidly embedded in the setting material and that all cavities are filled to prevent the collection of alkaline water.

Anodized aluminum profiles feature an anodized layer that retains a uniform appearance during normal use. The surface, however, is susceptible to scratching and wear and may be damaged by grout or setting material. Therefore, these materials must be removed immediately. Otherwise, the description regarding aluminum applies.

Color-coated aluminum and **textured color-coated aluminum** are pretreated (chromated) aluminum that is color-coated with a polyurethane powder coat. The coating is color-stable, UV-resistant, and suitable for exterior use. Protect the profile against abrasion or scratching.

PVC profiles are made of pre-colored, rigid PVC that resists bending or scratching. The material is UV-resistant, though not permanently color-stable, in exterior applications. PVC profiles are not suited for corners or transitions subjected to heavy mechanical stresses (e.g., at step edges or floor transitions).

Note: Due to variations in raw materials and manufacturing, the exact color, shade, and/or texture of individual profiles and related components (e.g., corners, end caps, connectors, etc.) may vary. The customer must inspect the products upon delivery and notify Schluter in writing of any physical damage to the products or nonconformity with the purchase order or invoice.

STAINLESS STEEL, CHROME-PLATED BRASS, AND SOLID BRASS

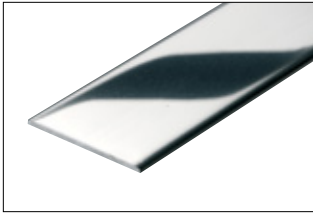

E Stainless steel 304 (1.4301=V2A)
High-grade stainless steel 316 L
(1.4404=V4A)

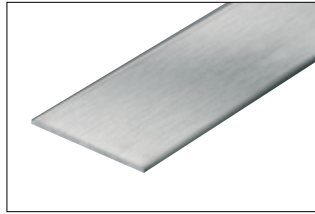

EB Brushed stainless steel

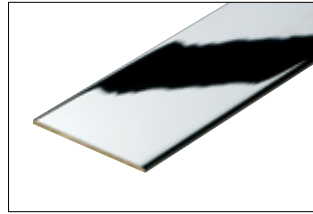

MC Chrome-plated solid brass

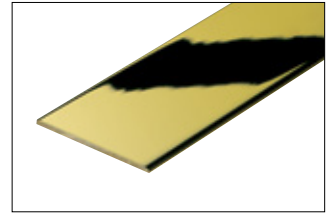

M Solid brass

ALUMINUM

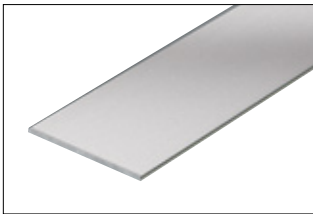

A Aluminum

ANODIZED ALUMINUM

Polished and bright anodized aluminum



ACG Polished chrome
anodized aluminum
ACB Bright chrome
anodized aluminum

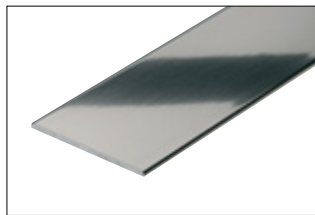

ATG Polished nickel
anodized aluminum

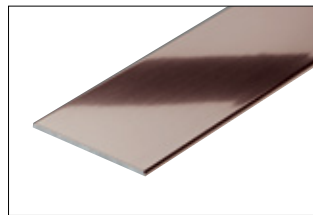

AKG Polished copper
anodized aluminum

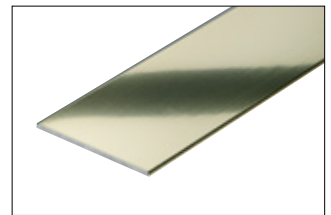

AMG Polished brass
anodized aluminum

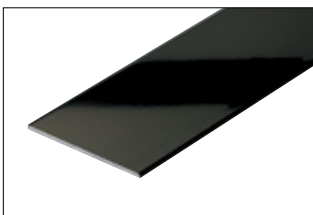

AGSG Bright black
anodized aluminum

Note: Due to variations in raw materials and manufacturing, the exact color, shade, and/or texture of individual profiles and related components (e.g., corners, end caps, connectors, etc.) may vary. The customer must inspect the products upon delivery and notify Schluter in writing of any physical damage to the products or nonconformity with the purchase order or invoice.

Satin anodized aluminum

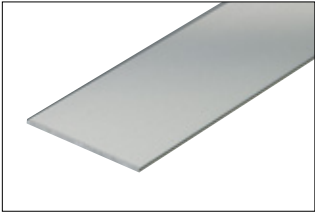

AE Satin anodized aluminum

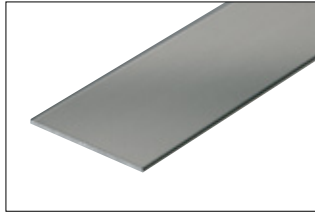

AT Satin nickel anodized aluminum

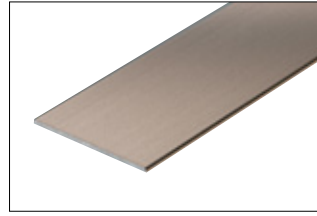

AK Satin copper anodized aluminum

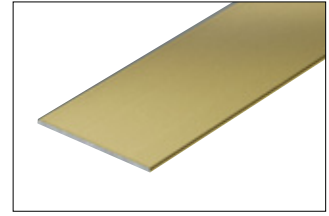

AM Satin brass anodized aluminum



AGR Graphite anodized aluminum

Brushed anodized aluminum

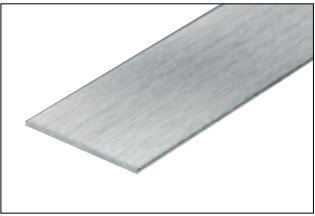

ACGB Brushed chrome anodized aluminum



ATGB Brushed nickel anodized aluminum

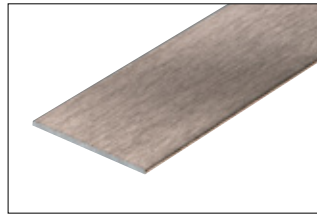

AKGB Brushed copper anodized aluminum

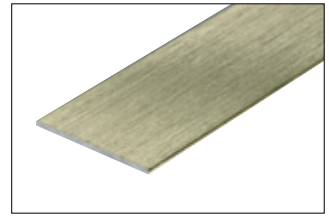

AMGB Brushed brass anodized aluminum



ABGB Brushed antique bronze anodized aluminum



AGRB Brushed graphite anodized aluminum

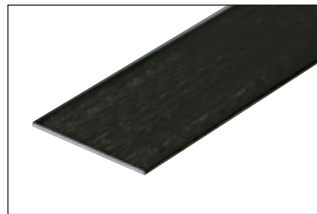

AGSB Brushed black anodized aluminum

Note: Due to variations in raw materials and manufacturing, the exact color, shade, and/or texture of individual profiles and related components (e.g., corners, end caps, connectors, etc.) may vary. The customer must inspect the products upon delivery and notify Schluter in writing of any physical damage to the products or nonconformity with the purchase order or invoice.

TEXTURED COLOR-COATED ALUMINUM

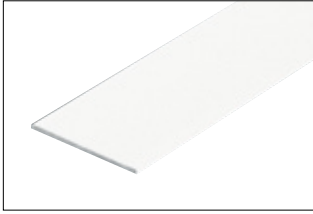

MBW Matte white textured color-coated aluminum
RAL 9003

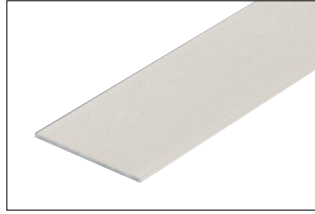

TSI Ivory textured color-coated aluminum

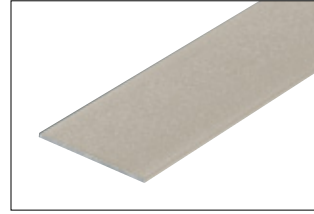

TSBG Greige textured color-coated aluminum

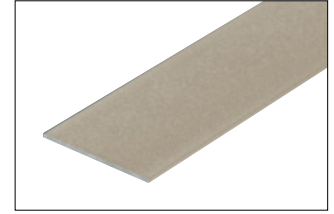

TSC Cream textured color-coated aluminum



TSB Beige textured color-coated aluminum

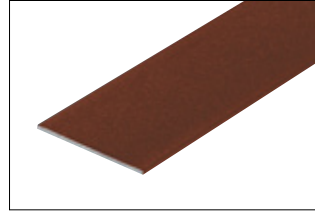

TSR Rustic brown textured color-coated aluminum

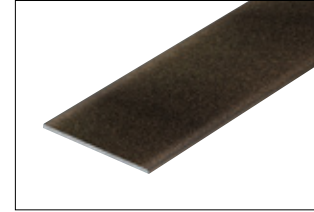

TSOB Bronze textured color-coated aluminum

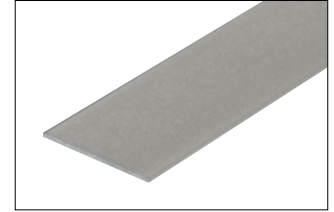

TSSG Stone grey textured color-coated aluminum

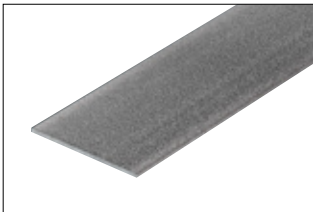

TSG Pewter textured color-coated aluminum



TSLA Light anthracite textured color-coated aluminum



TSDA Dark anthracite textured color-coated aluminum



MGS Matte black textured color-coated aluminum
RAL 9005

Note: Due to variations in raw materials and manufacturing, the exact color, shade, and/or texture of individual profiles and related components (e.g., corners, end caps, connectors, etc.) may vary. The customer must inspect the products upon delivery and notify Schluter in writing of any physical damage to the products or nonconformity with the purchase order or invoice.

COLOR-COATED ALUMINUM

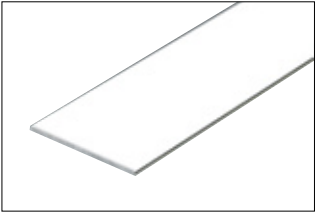

BW Bright white
color-coated aluminum
RAL 9003

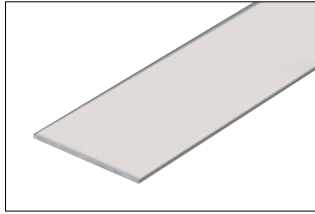

W White
color-coated aluminum
RAL 9010

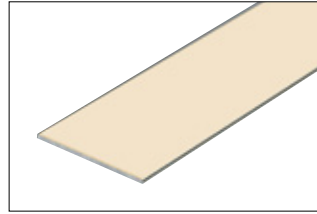

SP Sand pebble
color-coated aluminum
RAL N/A

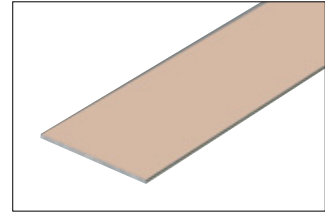

BH Bahama
color-coated aluminum
RAL N/A

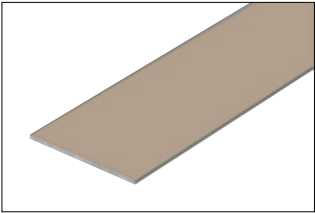

HB Light beige
color-coated aluminum
RAL 1019

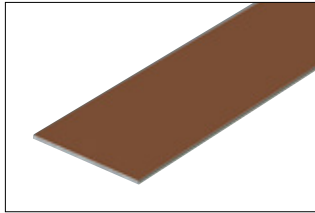

RB Red brown
color-coated aluminum
RAL 8003

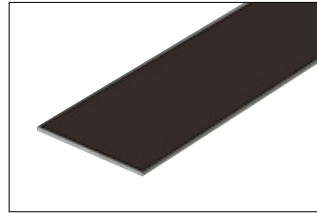

SB Black brown
color-coated aluminum
RAL 8019

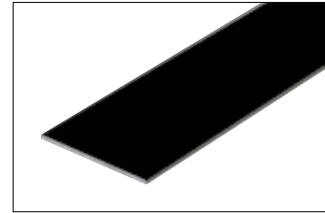

GS Black
color-coated aluminum
RAL 9011

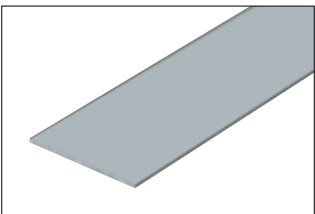

HG Light grey
color-coated aluminum
RAL 7035

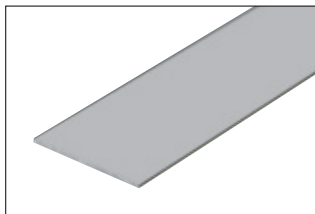

PG Classic grey
color-coated aluminum
RAL N/A

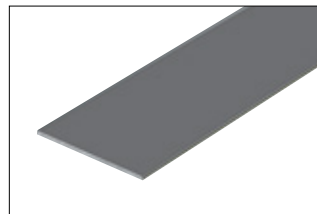

G Grey
color-coated aluminum
RAL 7030

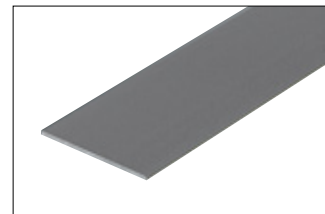

GM Metallic grey
color-coated aluminum
RAL 9006

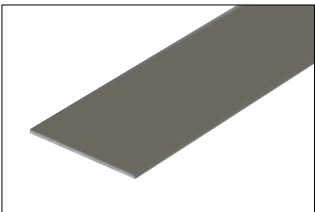

QG Quartz grey
color-coated aluminum
RAL 7039

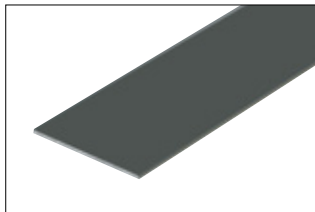

VG Traffic grey
color-coated aluminum
RAL 7043

Note: Due to variations in raw materials and manufacturing, the exact color, shade, and/or texture of individual profiles and related components (e.g., corners, end caps, connectors, etc.) may vary. The customer must inspect the products upon delivery and notify Schluter in writing of any physical damage to the products or nonconformity with the purchase order or invoice.

PVC

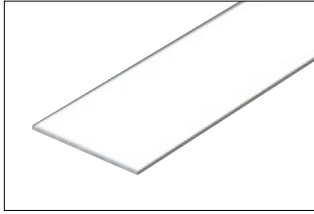

BW Bright white
PVC
RAL 9003

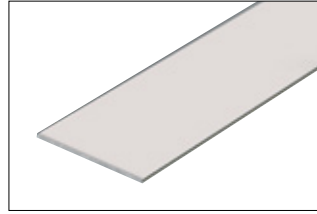

W White
PVC
RAL 9010

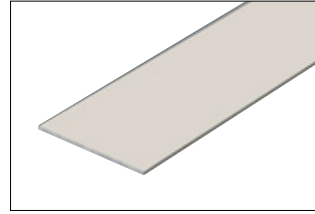

C Cream
PVC
RAL N/A

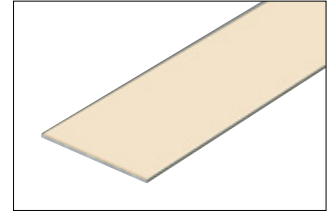

SP Sand pebble
PVC
RAL N/A

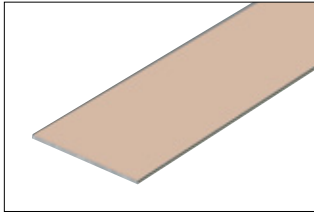

BH Bahama
PVC
RAL N/A

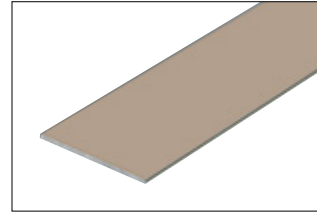

HB Light beige
PVC
RAL 1019

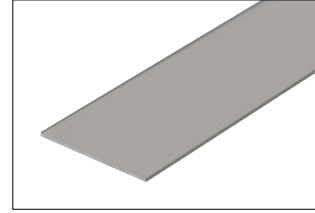

FG Grout grey
PVC
RAL N/A

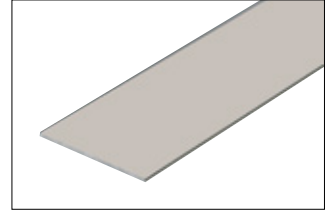

SG Stone grey
PVC
RAL N/A

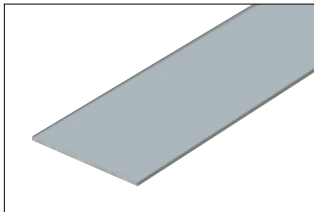

HG Light grey
PVC
RAL 7035

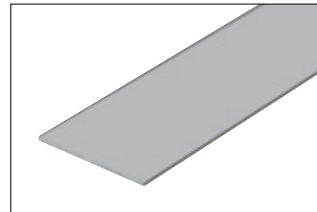

PG Classic grey
PVC
RAL N/A

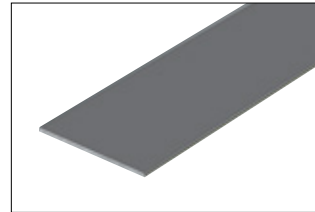

G Grey
PVC
RAL 7030

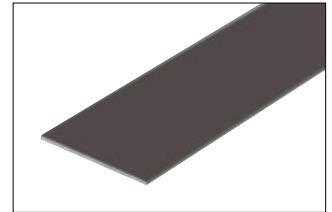

DA Dark anthracite
PVC
RAL N/A

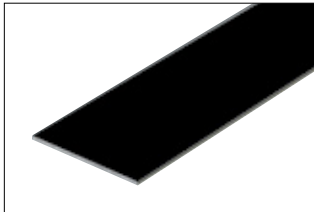

GS Black
PVC
RAL 9011

Note: Due to variations in raw materials and manufacturing, the exact color, shade, and/or texture of individual profiles and related components (e.g., corners, end caps, connectors, etc.) may vary. The customer must inspect the products upon delivery and notify Schluter in writing of any physical damage to the products or nonconformity with the purchase order or invoice.

Products	Anodized Aluminum														Stainless steel										Insert Color														
	Finishes	A	ABGB	ACB	ACG	ACGB	ACG	ACGB	AE	AGR	AGRB	AGSB	AGSG	AK	AKGB	AM	AMGB	AT	ATG	ATGB	E	EB	CG	G	GS	HB	NB	SP	FG	SG	HG	T							
Products	Colors	BH	BW	C	(PVC only)	DA	(PVC only)	FG	(PVC only)	G	GM	(Alum only)	GS	HB	HG	PG	QG	(Alum only)	RB	(Alum only)	SB	(Alum only)	SG	(PVC only)	SP	VG	(Alum only)	W											
Stair-nosing profiles																																							
RONDEC-STEP																																							
SCHIENE-STEP																																							
TREP-FL																																							
TREP-E/-EK																																							
TREP-G/-GK																																							
TREP-V																																							
TREP-SE/-S/-B																																							
TREP-TAP																																							
PVC and Color-coated Aluminum																																							
Products	Colors	BH	BW	C	(PVC only) <td>DA</td> <td>(PVC only) <td>FG</td> <td>(PVC only) <td>G</td> <td>GM</td> <td>(Alum only) <td>GS</td> <td>HB</td> <td>HG</td> <td>PG</td> <td>QG</td> <td>(Alum only) <td>RB</td> <td>(Alum only) <td>SB</td> <td>(Alum only) <td>SG</td> <td>(PVC only) <td>SP</td> <td>VG</td> <td>(Alum only) <td>W</td> </td></td></td></td></td></td></td></td>	DA	(PVC only) <td>FG</td> <td>(PVC only) <td>G</td> <td>GM</td> <td>(Alum only) <td>GS</td> <td>HB</td> <td>HG</td> <td>PG</td> <td>QG</td> <td>(Alum only) <td>RB</td> <td>(Alum only) <td>SB</td> <td>(Alum only) <td>SG</td> <td>(PVC only) <td>SP</td> <td>VG</td> <td>(Alum only) <td>W</td> </td></td></td></td></td></td></td>	FG	(PVC only) <td>G</td> <td>GM</td> <td>(Alum only) <td>GS</td> <td>HB</td> <td>HG</td> <td>PG</td> <td>QG</td> <td>(Alum only) <td>RB</td> <td>(Alum only) <td>SB</td> <td>(Alum only) <td>SG</td> <td>(PVC only) <td>SP</td> <td>VG</td> <td>(Alum only) <td>W</td> </td></td></td></td></td></td>	G	GM	(Alum only) <td>GS</td> <td>HB</td> <td>HG</td> <td>PG</td> <td>QG</td> <td>(Alum only) <td>RB</td> <td>(Alum only) <td>SB</td> <td>(Alum only) <td>SG</td> <td>(PVC only) <td>SP</td> <td>VG</td> <td>(Alum only) <td>W</td> </td></td></td></td></td>	GS	HB	HG	PG	QG	(Alum only) <td>RB</td> <td>(Alum only) <td>SB</td> <td>(Alum only) <td>SG</td> <td>(PVC only) <td>SP</td> <td>VG</td> <td>(Alum only) <td>W</td> </td></td></td></td>	RB	(Alum only) <td>SB</td> <td>(Alum only) <td>SG</td> <td>(PVC only) <td>SP</td> <td>VG</td> <td>(Alum only) <td>W</td> </td></td></td>	SB	(Alum only) <td>SG</td> <td>(PVC only) <td>SP</td> <td>VG</td> <td>(Alum only) <td>W</td> </td></td>	SG	(PVC only) <td>SP</td> <td>VG</td> <td>(Alum only) <td>W</td> </td>	SP	VG	(Alum only) <td>W</td>	W											
Movement joint and cove-shaped profiles																																							
DILEX-EKE																																							
DILEX-BWA																																							
DILEX-HKW																																							
DILEX-HK																																							
DILEX-PHK																																							
DILEX-BWS																																							
DILEX-BWB																																							
DILEX-F																																							
DILEX-AS																																							
Anodized Aluminum																																							
Products	Finishes	A	ABGB	ACB	ACG	ACGB	AE	AGR	AGRB	AGSB	AGSG	AK	AKGB	AM	AMGB	AT	ATG	ATGB	E	EB	M	MC	MBW	MG	MG	MSB	TSC	TSDA	TSG	TSI	TSLA	TSOB	TSR	TSSG					
Movement joint and cove-shaped profiles																																							
DILEX-AHK																																							
DILEX-AHKA																																							
DILEX-EHK/-HKU																																							
DILEX-EDP																																							
DILEX-HKS																																							
DILEX-KSN																																							
DILEX-AKWS																																							
DILEX-KSA																																							
DILEX-EKSB																																							
Profiles for resilient floor and wall coverings																																							
VINPRO																																							

Warranty Program Summary

All Schluter®-Systems products are covered under our warranty program. Products are warranted for the applicable term from the date of purchase only when the products are used and installed in accordance with the terms and conditions of the applicable Schluter®-Systems technical literature and industry standard guidelines that are not in conflict with the technical literature.

There are four different categories of warranties as follows:

Systems

Systems are application based and include a variety of products that form an integrated system. Systems are defined by installation handbooks.

- Schluter®-DITRA and DITRA-XL uncoupling membranes
- Schluter®-DITRA-HEAT and DITRA-HEAT-PS electric floor warming system with integrated uncoupling technology
- Schluter®-Shower System

Lifetime

When you install Schluter®-DITRA/DITRA-XL, the Schluter®-Shower System, KERDI/KERDI-DS, DITRA-HEAT/DITRA-HEAT-DUO or DITRA-HEAT-PS/DITRA-HEAT-DUO-PS with one of our Schluter thin-set mortars, your installation may be eligible for limited lifetime warranty coverage.

Consolidated Products

Consolidated products are products with similar characteristics or functions that are grouped under a single warranty document. These product groups are defined by technical data sheets.

- Floor profiles
- Wall and countertop profiles
- Stair-nosing profiles
- Movement joints and cove-shaped profiles
- Resilient floor and wall covering profiles
- Schluter®-BEKOTEC modular screed panels
- Schluter®-KERDI-DRAIN, KERDI-DRAIN-H, KERDI-DRAIN-F, KERDI-LINE and KERDI-LINE-VARIO drains
- Schluter®-KERDI and KERDI-DS waterproofing membranes
- Schluter®-SET, ALL-SET and FAST-SET thin-set mortars

Individual Products

Individual products are those that do not fit into a current consolidated product group and therefore have a separate warranty document. These products are defined by technical data sheets.

- Schluter®-KERDI-BOARD building panels
- Schluter®-KERDI-BOARD-SNLT niches with LED lighting
- Schluter®-LIPROTEC drivers and cables
- Schluter®-REFLEECE removable fleece
- Schluter®-DITRA-HEAT-E thermostats
- Schluter®-KERDI-FIX adhesive/sealant
- Schluter®-PRIMER-U universal primer
- Tools

For complete warranty information, please see our website: [Schluter.com/warranty](https://www.schluter.com/warranty).

CONDITIONS OF SALE

1. Terms and Conditions

These terms and conditions of sale (hereinafter referred to as the "Terms") govern the sale of Products from Schluter Systems L.P. ("Schluter") to Customer where such products are to be used within the United States and its territories. "Products" is defined to mean the products identified on the order confirmation or invoice, whichever is issued later by Schluter to Customer; and "Customer" is defined to mean the purchasing entity identified on such documents. The Terms herein, the terms and conditions contained on any order confirmation and/or invoice, and the terms and conditions contained in any applicable Credit Application, and/or supply agreement between Schluter and Customer, if any, represent the final and complete agreement of Schluter and Customer as to the sale and purchase of Products (the "Agreement"). In the event of any conflicting terms or conditions in the Agreement, the supply agreement, if any, shall be deemed to control; in the absence of a supply agreement, the order confirmation shall be deemed to control. Any and all different or additional terms than those contained in the Agreement are rejected unless expressly accepted in writing by an authorized representative of Schluter.

2. Price and Payment

Payment terms are net thirty (30) days from invoice date. No payments shall be subject to any setoffs, deductions or claims. For any amounts not paid by Customer as of the due date, Customer shall be liable to pay interest on the amount due at a rate of 1.5% per month from due date until date of payment in addition to the principal amount. Regardless of any statement appearing on a check or otherwise, Schluter's acceptance of a payment in an amount less than that due shall in no way be an accord and satisfaction or prejudice Schluter's rights and remedies to collect the full amount due. Prices do not include sales taxes or other charges levied by any governmental authority upon the sale, use or transportation of the Products, all of which shall be paid by Customer, including, without limitation, applicable customs duties and tariffs. Prices quoted in the Price List Catalog are subject to change without prior notice.

For the most current version of the Price List, please visit www.schluter.com.

3. Shipping/Title/Risk of Loss

Unless otherwise expressly set forth in writing by Schluter, all Products will be delivered Ex Works (as defined in Incoterms 2017 revision). Dates of shipments are estimated and not guaranteed. Title and risk of loss to Products shall transfer to Customer upon delivery in accordance with the applicable delivery terms. Any handling of the Products after transfer of risk of loss shall be at Customer's sole risk.

4. Freight and Shipping Charges

Prices quoted in the Price List Catalog include ground freight (best way) charges within the continental USA, save and except for purchase orders under \$10,000 gross at retail, to which freight charges according to the table below will be added thereto.

Ground Freight (Best Way) Charges				
Orders up to \$500	\$500 to \$1,500	\$1,500 to \$3,000	\$3,000 to \$5,000	\$5,000 to \$10,000
\$65	\$85	\$125	\$200	\$300

Schluter offers express shipping to the continental USA; please see applicable table below for options and pricing. Next day and second day shipping is also applicable for Alaska and Hawaii. Please note that "shipping days" represent business days.

Express Handling Freight Charges				
Gross order value at retail	up to \$500	\$500 to \$1,500	\$1,500 to \$3,000	\$3,000 to \$5,000
Next day	\$125	\$220	\$300	\$400
Second day	\$100	\$180	\$275	\$350
Third day	\$85	\$140	\$200	\$260

Express orders greater than \$5,000 gross at retail are charged actual freight.

Certain items with oversized shipping dimensions are not eligible for express shipping. Additionally, certain items (such as 10' profiles) are not eligible for parcel shipping and are subject to an additional \$300 charge unless combined with an order exceeding \$10,000 gross at retail.

Freight charges including air express handling charges are subject to change without prior notice. Please note that we are unable to accommodate third party transport billing.

Accessories:

Accessories include corners and caps for profiles and Rema kits up to \$500 gross at retail:

Regular ground handling	Next-day express handling
\$30	\$50

Accessory orders over \$500 gross at retail are subject to standard shipping charges.

KERDI-BOARD panels:

- 1 to 5 full pallets: \$150/pallet
- 6+ full pallets: free shipping

THIN-SET pallets: minimum order equals 4 full pallets (1 pallet equals 56 bags per item number)

- 4 to 14 full pallets: \$500 freight charge per order
- 15 pallets: free shipping

Bundle offers for thin-set pallets with other products (i.e. DITRA and KERDI) are available and are eligible for free shipping. Please consult with a Schluter Sales Representative for more details.

3rd party shipping (drop shipping):

- Orders to a third party will incur a 10% handling fee.
- THIN-SET only orders to a third party will incur a \$200 handling fee.

5. Product Inspection; Non-conformity

Customer must inspect the Products upon delivery and notify Schluter in writing of any physical damage to the Products or nonconformity with the purchase order or invoice. FAILURE TO INSPECT AND DELIVER WRITTEN NOTICE OF SUCH DAMAGE OR NONCONFORMITY WITHIN SUCH FORTY EIGHT (48) HOUR PERIOD SHALL CONSTITUTE IRREVOCABLE ACCEPTANCE OF THE DELIVERED PRODUCTS AND A WAIVER OF ANY DAMAGE OR NONCONFORMITY THAT WAS OR SHOULD HAVE BEEN DETECTED. Any use of the Products or any portion thereof shall constitute irrevocable acceptance of such Products. As Customer's sole remedy for any damaged or nonconforming Products of which Customer has delivered to Schluter timely notice of damaged or nonconforming Products, Schluter, at Schluter's sole election, shall either: (a) replace the damaged or nonconforming Products, or (b) refund the price paid by Customer to Schluter for such damaged or nonconforming Products. In no event shall Schluter be liable for costs of procurement or substitute Products by Customer, or for injury or damage to business, or loss of profits, nor shall Schluter be liable for any incidental, special, indirect, or consequential damages. Any Product images are for illustrative purposes only; any differences between Product images and actual Product received shall not constitute nonconforming Product.

6. Cancellations

If Customer fails to make payment in accordance, or otherwise comply, with all terms of the Agreement, Schluter may, at its option (and in addition to all other remedies), cancel any unshipped portion of Customer's order, without liability to Schluter, and Customer shall remain liable for all unpaid amounts. Subject only to Section 5 herein, orders, once accepted by Schluter, cannot be cancelled without Schluter's prior written consent, which may be granted or withheld in Schluter's sole and absolute discretion. In no event shall Schluter authorize the cancellation or deferment of shipment unless Schluter is indemnified against the loss resulting therefrom. Orders issued a tracking number are considered shipped; any cancellation or deferment will incur a 25% restocking fee.

7. Returns

Schluter shall not accept any returns unless it specifically authorizes such in writing, which may be granted or withheld in Schluter's sole and absolute discretion. Under no circumstances shall Schluter accept any returned Products after thirty (30) days from such Products' invoice date. Any authorized returns must be in resellable condition subject to inspection by Schluter prior to acceptance of same. All authorized returns shall incur a handling charge of 25%.

8. Special Orders

Customer will defend, at its own expense, any suit which may be brought against Schluter by reason of the manufacture or sale of special or non-stock Products made to Customer's specifications, including any third party proceedings. In the case of cancellation of orders of special or non-stock Products, Customer's cancellation may be conditioned upon Customer's payment in full of the price of finished Products. Schluter shall not accept any returns of special or non-stock Products.

9. Warranty and Damages Disclaimer

a. Warranty The Products are covered by product-specific warranties, available at www.schluter.com or Schluter's Warranties Page. The warranty that applies is the applicable warranty in effect for the Products as of the date of the proforma invoice, or if no proforma invoice, as of the date of the order acknowledgement for the Products (the "Written Warranty").

b. Disclaimer THE WRITTEN WARRANTY IS THE ONLY WARRANTY APPLICABLE TO THE PRODUCTS AND EXCLUDES ALL OTHER WARRANTIES, INCLUDING, WITHOUT LIMITATION, ANY IMPLIED WARRANTY OF MERCHANTABILITY OR FITNESS FOR A PARTICULAR PURPOSE, AND ANY IMPLIED WARRANTIES OTHERWISE ARISING FROM A COURSE OF DEALING OR USAGE OF TRADE, EXCEPT WHERE PURCHASE OF THE PRODUCTS IS SUBJECT TO CONSUMER PRODUCT WARRANTY LAWS, IN WHICH INSTANCES ANY APPLICABLE IMPLIED WARRANTIES ARE LIMITED TO THE PERIOD OF THE APPLICABLE WRITTEN WARRANTY, OR SUCH SHORTER PERIOD AS PERMITTED OR REQUIRED UNDER APPLICABLE LAW. IN NO EVENT WILL SCHLUTER BE LIABLE FOR ANY INCIDENTAL, SPECIAL, INDIRECT, OR CONSEQUENTIAL DAMAGES, HOWEVER CAUSED, WHETHER FOR BREACH OF CONTRACT, BREACH OF WARRANTY, TERMINATION, NEGLIGENCE, OR OTHERWISE, EVEN IF SCHLUTER SHALL HAVE BEEN ADVISED OF THE POSSIBILITY OF SUCH DAMAGES. Recommendations, advice, representations, warranties, commitments or agreements that are inconsistent with the foregoing disclaimer shall not be binding on Schluter unless in a writing signed by an authorized representative of Schluter. Schluter's only obligation is to provide the Products in the quantities ordered by Customer (which order is accepted by Schluter) without regard to the Products' appropriateness to Customer's application. Customer represents and warrants that Customer is not a "consumer" as defined by any applicable usury or consumer protection laws.

10. Delay/Force Majeure

Delay in delivery or nondelivery by Schluter shall not be a breach or default by Schluter if performance is delayed or made impracticable or impossible by the occurrence of any one or more of the following: (a) fire, flood, or other casualty, (b) war, riot, embargo, governmental regulation or martial law, (c) inability to obtain necessary materials from usual sources of supply, (d) shortage of transportation or delays in transit, (e) strike or other labor issue, and (f) other conditions not reasonably within Schluter's control, whether or not of a kind mentioned herein.

11. Choice of Law

For sales made in the United States or its territories, the Agreement (including, without limitation, these Terms) shall be governed by the State of New York, without regard for its choice of law provisions.

12. Arbitration

a. Any controversy, claim or dispute arising out of or in connection with the Agreement shall be settled by final and binding arbitration administered by the American Arbitration Association in accordance with its Commercial Arbitration Rules in Plattsburgh, Clinton County, state of New York and judgment on the award rendered by the arbitrator may be entered in any court having jurisdiction. The arbitration shall be heard by a single arbitrator appointed in accordance with the Commercial Arbitration Rules, and shall be conducted in English.

b. If a controversy or claim relates to or is the subject of a mechanic's or construction lien, Schluter may proceed in accordance with applicable law to preserve and enforce its lien rights. TO THE FULLEST EXTENT PERMITTED BY LAW, NOTWITHSTANDING ANY ARBITRATION RULE OR PROCEDURE, (A) NO CONTROVERSY OR CLAIM ARISING OUT OF OR RELATING TO THE AGREEMENT SHALL BE CONSOLIDATED OR JOINED WITH ANY OTHER PERSON'S CLAIM AND NO CLASS ACTION OR REPRESENTATIVE ACTIONS SHALL BE PERMITTED UNDER THE AGREEMENT, AND (B) IF ANY CLASS OR REPRESENTATIVE ACTION CANNOT BE WAIVED UNDER APPLICABLE LAW, THE PARTIES AGREE THAT SUCH ACTION SHALL BE ARBITRATED.

13. Miscellaneous

No amendment, alteration, variation, deletion, addition, and/or cancellation of these Terms made by Customer shall be of any force or effect unless reduced to writing and signed by a director of Schluter. If any clause, subclause, or other provision of these Terms is invalid under any statute or rule of law, such provision, to that extent only, shall be deemed to be omitted without affecting the validity of the remainder of the Terms. Customer shall pay to Schluter all costs of collection, including, without limitation, reasonable attorneys' fees, incurred by Schluter in enforcing the Agreement, including, without limitation, collecting any money due from Customer and enforcing Schluter's lien rights. No waiver by Schluter of any term or any obligation of Customer shall constitute a waiver of any other term or obligation. Customer shall not assign or transfer its rights or obligations under the Agreement without the prior written consent of Schluter. All of Customer's representations, warranties and indemnities under the Agreement shall survive the consummation of or the termination or cancellation of any purchase and sale of Products. Which party prepared the Agreement shall have no bearing on the construction or interpretation of the Agreement. Buyer will defend, at its own expense, any suit or legal proceeding, including any third party proceedings, which may be brought against Schluter by reason of the manufacture or sale of any special product(s) made to Buyer's specifications. These Terms supersede all prior versions of Schluter's Conditions of Sale. Schluter reserves the right in its sole discretion to amend these Terms from time to time and any such amended terms and conditions shall be binding on Customer. For the most current version of the Terms, please visit www.schluter.com/terms.

Copyright Notice

The Schluter-Systems Illustrated Price List is protected by copyright laws. Its entire content, including images and text, may not be reproduced, distributed, modified, reused, or otherwise used without the express written permission of Schluter-Systems.

© 2024 Schluter-Systems. All rights reserved.

Trademark Notice

All product names, logos and/or designs, including but not limited to those listed on our website, [Schluter.com/trademarks](https://www.schluter.com/trademarks), are owned by Schluter-Systems. It may not be a complete list of trademarks owned by Schluter-Systems as it does not list all common law trademarks and trademark applications or registrations worldwide. The unauthorized use or misuse of these trademarks is expressly prohibited and may be in violation of intellectual property rights which shall be enforced.

Scan here
to download
a digital copy

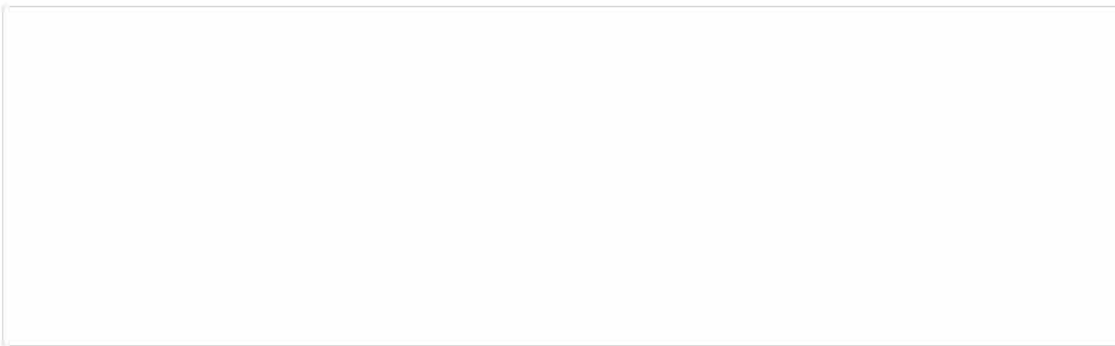

Schluter Systems L.P. • 194 Pleasant Ridge Road, Plattsburgh, NY 12901-5841
Tel.: 800-472-4588 • Fax: 800-477-9783

Schluter.com