

2025

Illustrated Price List

Effective April 1, 2025

USA





Dear Tile Professional,

Constant development of innovative solutions for ceramic tile and natural stone installations is the cornerstone of our tradition at Schluter. The Illustrated Price List, which you hold in your hands, features new and improved products that reflect that tradition.

A perfect example is Schluter®-SCHIENE, which became the foundation of Schluter's success in 1975. In our tradition of innovation, the simple right-angle profile has since evolved to include an integrated joint spacer. Often, small details result in large advantages for the installer. In this case, the integrated joint spacer makes tile setting easier and cleaner. Gradually, all of our products will be equipped with this feature.

To a large degree, Schluter-Systems owes its position as market leader to you, our industry partner. Your input has helped us improve on the function, aesthetic appeal, and safety of our products. Hence, we will keep our ear to the market, so that we may continue to deliver high quality, professional products to specifiers and architects, distributors and dealers, contractors and owners.

Sincerely,

Werner Schlüter

















1975 - 1981



1981 - 2000



2000 - present

	Product Overview	4 - 12
	Finishing, edge-protection, & transition profiles for floors	13 - 23
	Finishing & edge-protection profiles for walls & countertops	24 - 60
	Stair-nosing profiles	61 - 72
	Movement joint & cove-shaped profiles	73 - 94
	Profiles for resilient floor & wall coverings	95 - 99
	Waterproof substrates & building panels	100 - 108
	Waterproofing & uncoupling membranes	109 - 115
	Removable fleece	116 - 117
	Electric floor warming system	118 - 125
	Shower system	126 - 187
	Modular screed system for conventional & radiant-heated screeds	188 - 190
	Setting materials	191 - 195
	Tools	196 - 197



A

Schluter®-ALL-SET 192

B

Schluter®-BEKOTEC 189

Schluter®-BEKOTEC-BRS 190

Schluter®-BEKOTEC-BRSK 190

Schluter®-BEKOTEC-BRS/KF 190

Schluter®-BEKOTEC-BRS/KSF 190

Schluter®-BEKOTEC-F 189

Schluter®-BEKOTEC-THERM-RH 75 190

D

Schluter®-DECO 18

Schluter®-DECO-DE 46

Schluter®-DECO-SG 49 & 186

Schluter®-DECO-SGC 50 & 187

▲ Schluter®-DESIGN-NICHE 166 & 167

Schluter®-DESIGNBASE-SL 59-60

Schluter®-DESIGNLINE 48

Schluter®-DILEX-AHK 85-88

Schluter®-DILEX-AHKA 89-90

Schluter®-DILEX-AKWS 77

Schluter®-DILEX-AS 81

Schluter®-DILEX-BT 79

Schluter®-DILEX-BTO 79

Schluter®-DILEX-BTS 80

Schluter®-DILEX-BWA 82

Schluter®-DILEX-BWB 76

Schluter®-DILEX-BWS 75

Schluter®-DILEX-DFP 190

Schluter®-DILEX-EDP 78

Schluter®-DILEX-EHK 92

Schluter®-DILEX-EKE 82

Schluter®-DILEX-EKSB 78

Schluter®-DILEX-EZ 6 + 9 75

Schluter®-DILEX-F 76

Schluter®-DILEX-HK 84

Schluter®-DILEX-HKS 93

Schluter®-DILEX-HKU 94

Schluter®-DILEX-HKW 83

Schluter®-DILEX-KSA 81

Schluter®-DILEX-KSN 77

Schluter®-DILEX-MOP 74

Schluter®-DILEX-MP/-MPV 74

Schluter®-DILEX-PHK 91

▲ Schluter®-DILEX-STF 80

Schluter®-DITRA 110

Schluter®-DITRA-HEAT 119

Schluter®-DITRA-HEAT-DUO 119

Schluter®-DITRA-HEAT-DUO-PS 120

Schluter®-DITRA-HEAT-E-HK 121

Schluter®-DITRA-HEAT-E-R 124

Schluter®-DITRA-HEAT-E-RR 124

Schluter®-DITRA-HEAT-E-RRS 125

Schluter®-DITRA-HEAT-E-RS1 125

Schluter®-DITRA-HEAT-E-RT 124

Schluter®-DITRA-HEAT-E-WiFi 124

Schluter®-DITRA-HEAT-PS 120

▲ Schluter®-DITRA-PS 111

Schluter®-DITRA-ROLLER 196

Schluter®-DITRA-XL 110

E

Schluter®-ECK-E 56

Schluter®-ECK-K 57

Schluter®-ECK-KHK 58

F

Schluter®-FAST-SET 192

Schluter®-FINEC 45

Schluter®-FINEC-SQ 44

I

Schluter®-INDEC 46

J

Schluter®-JOLLY 25-28

Schluter®-JOLLY-P 29

K

Schluter®-KERDI 112 & 127

Schluter®-KERDI-BAND 108, 113 & 128

Schluter®-KERDI-BOARD 101

Schluter®-KERDI-BOARD-E 102

Schluter®-KERDI-BOARD-KIT 172

Schluter®-KERDI-BOARD-SB 103 & 161

Schluter®-KERDI-BOARD-SC 103 & 160

Schluter®-KERDI-BOARD-SN 104 & 161





NEW!

DITRA-PS
Peel & stick uncoupling membrane
(page 111)

PRIMER-PS
Primer for peel & stick membranes
(page 195)

Schluter®-KERDI-BOARD-SNLT 163-164

Schluter®-KERDI-BOARD-U 102

Schluter®-KERDI-BOARD-V 102

Schluter®-KERDI-BOARD-ZA 105

Schluter®-KERDI-BOARD-ZB 106

Schluter®-KERDI-BOARD-ZC 105

Schluter®-KERDI-BOARD-ZDK 108

Schluter®-KERDI-BOARD-ZFP 107

Schluter®-KERDI-BOARD-ZS 107

Schluter®-KERDI-BOARD-ZSA 108 & 117

Schluter®-KERDI-BOARD-ZSD 106

Schluter®-KERDI-BOARD-ZT 107

Schluter®-KERDI-BOARD-ZW 106

Schluter®-KERDI-DRAIN/-A/-H 132-142

Schluter®-KERDI-DRAIN-F 143

Schluter®-KERDI-DS 112 & 127

Schluter®-KERDI-FIX 115 & 187

Schluter®-KERDI-FLEX 111

Schluter®-KERDI-KERECK-F 113 & 128

Schluter®-KERDI-KERS 114 & 129

Schluter®-KERDI-KERS-B 114 & 129

Schluter®-KERDI-KM 115 & 130

Schluter®-KERDI-LINE 146-152

▲ Schluter®-KERDI-LINE-A 152

Schluter®-KERDI-LINE-FC 153

Schluter®-KERDI-LINE-VARIO 154-156

Schluter®-KERDI-SEAL-PS/-MV 115 & 130

Schluter®-KERDI-SHOWER-CB 160

Schluter®-KERDI-SHOWER-KIT 168-170

Schluter®-KERDI-SHOWER-LT/-LTS 159

Schluter®-KERDI-SHOWER-R 160

Schluter®-KERDI-SHOWER-T/-TS/-TT 158

Schluter®-KERDI-TUBKIT 171

L

Schluter®-LIPROTEC-CW 165

Schluter®-LIPROTEC-ECD 165

Schluter®-LIPROTEC-ECX 165

P

▲ Schluter®-PRIMER-PS 195

Schluter®-PRIMER-U 194

Schluter®-PROCUT-TSM 197

Q

Schluter®-QUADEC 39-42

Schluter®-QUADEC-FS 43

Schluter®-QUADEC-K 43

R

Schluter®-REFLEECE 117

Schluter®-REMA 60

Schluter®-RENO-RAMP 22

Schluter®-RENO-RAMP-K 22

Schluter®-RENO-T 19

Schluter®-RENO-TK 20

Schluter®-RENO-U 23

Schluter®-RENO-V 21

Schluter®-RONDEC 30-38

Schluter®-RONDEC-CT 53-54

Schluter®-RONDEC-DB 47

Schluter®-RONDEC-STEP 51-53 & 62-63

S

Schluter®-SCHIENE 15-17 & 29

Schluter®-SCHIENE-STEP 55 & 64

Schluter®-SET 192

Schluter®-SHELF 174-183

Schluter®-SHOWERPROFILE-R 184

Schluter®-SHOWERPROFILE-S 184

Schluter®-SHOWERPROFILE-WS 185

Schluter®-SHOWERPROFILE-WSK 185

Schluter®-SNIPS 197

T

Schluter®-TREP-E 66

Schluter®-TREP-EFK 72

Schluter®-TREP-EK 71

Schluter®-TREP-FL 65

Schluter®-TREP-G 67

Schluter®-TREP-GK 72

Schluter®-TREP-SE/-S/-B 69

Schluter®-TREP-TAP 70

Schluter®-TREP-V 68

Schluter®-TROWEL 196

V

Schluter®-VINPRO-RO 98

Schluter®-VINPRO-S 96

Schluter®-VINPRO-STEP 99

Schluter®-VINPRO-STEP-R 99

Schluter®-VINPRO-T 96

Schluter®-VINPRO-U 97



Schluter®-SCHIENE
Page 15 - 17



Schluter®-DECO
Page 18



Schluter®-RENO-T
Page 19



Schluter®-RENO-TK
Page 20



Schluter®-RENO-V
Page 21



Schluter®-RENO-RAMP/-K
Page 22



Schluter®-RENO-U
Page 23



Schluter®-JOLLY
Page 25 - 28



Schluter®-JOLLY-P
Page 29



Schluter®-SCHIENE
Page 29



Schluter®-RONDEC
Page 30 - 38



Schluter®-QUADEC
Page 39 - 42



Schluter®-QUADEC-K
Page 43



Schluter®-QUADEC-FS
Page 43



Schluter®-FINEC-SQ
Page 44



Schluter®-FINEC
Page 45



Schluter®-INDEC
Page 46



Schluter®-DECO-DE
Page 46

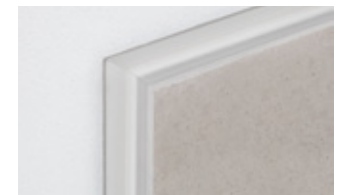

Schluter®-RONDEC-DB
Page 47

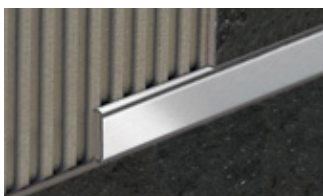

Schluter®-DESIGNLINE
Page 48



Schluter®-DECO-SG
Page 49



Schluter®-DECO-SGC
Page 50

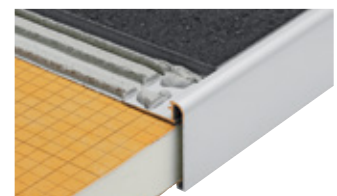

Schluter®-RONDEC-STEP
Page 51 - 53

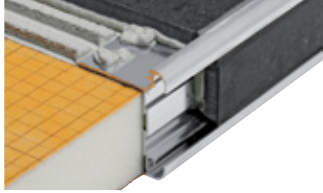

Schluter®-RONDEC-CT
Page 53 - 54

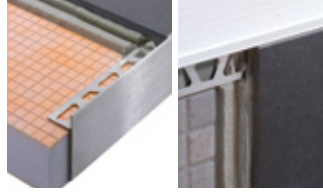

Schluter®-SCHIENE-STEP
Page 55



Schluter®-ECK-E
Page 56

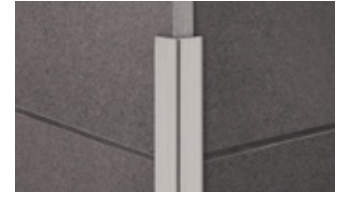

Schluter®-ECK-K
Page 57



Schluter®-ECK-KHK
Page 58



Schluter®-DESIGNBASE-SL
Page 59 - 60



Schluter®-REMA
Page 60

STAIR-NOSING PROFILES

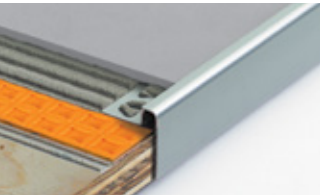

Schluter®-RONDEC-STEP
Page 62 - 63

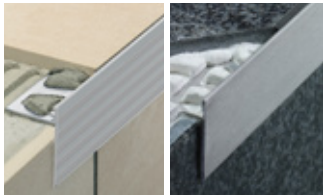

Schluter®-SCHIENE-STEP
Page 64



Schluter®-TREP-FL
Page 65



Schluter®-TREP-E
Page 66



Schluter®-TREP-G
Page 67



Schluter®-TREP-V
Page 68

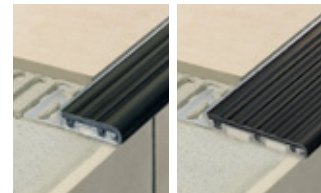

Schluter®-TREP-SE/-S/-B
Page 69

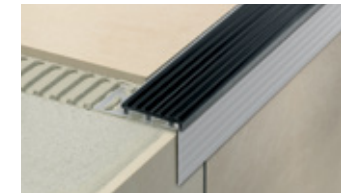

Schluter®-TREP-TAP
Page 70



Schluter®-TREP-EK
Page 71



Schluter®-TREP-EFK
Page 72



Schluter®-TREP-GK
Page 72



Schluter®-DILEX-MOP
Page 74



Schluter®-DILEX-MP/-MPV
Page 74



Schluter®-DILEX-EZ 6 + 9
Page 75



Schluter®-DILEX-BWS
Page 75



Schluter®-DILEX-BWB
Page 76

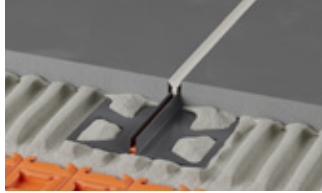

Schluter®-DILEX-F
Page 76

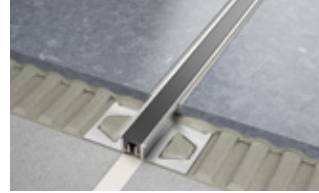

Schluter®-DILEX-KSN
Page 77



Schluter®-DILEX-AKWS
Page 77



Schluter®-DILEX-EKSB
Page 78



Schluter®-DILEX-EDP
Page 78



Schluter®-DILEX-BT
Page 79



Schluter®-DILEX-BTO
Page 79



Schluter®-DILEX-BTS
Page 80

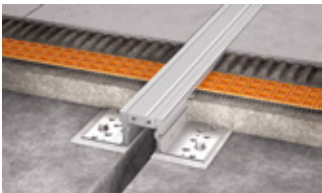

 Schluter®-DILEX-STF
Page 80



Schluter®-DILEX-AS
Page 81



Schluter®-DILEX-KSA
Page 81



Schluter®-DILEX-BWA
Page 82

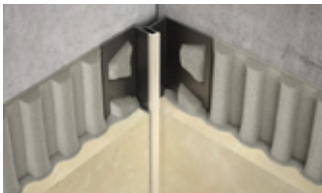

Schluter®-DILEX-EKE
Page 82



Schluter®-DILEX-HKW
Page 83



Schluter®-DILEX-HK
Page 84



Schluter®-DILEX-AHK
Page 85 - 88



Schluter®-DILEX-AHKA
Page 89 - 90



Schluter®-DILEX-PHK
Page 91



Schluter®-DILEX-EHK
Page 92



Schluter®-DILEX-HKS
Page 93



Schluter®-DILEX-HKU
Page 94



Schluter®-VINPRO-S
Page 96



Schluter®-VINPRO-T
Page 96



Schluter®-VINPRO-U
Page 97



Schluter®-VINPRO-RO
Page 98



Schluter®-VINPRO-STEP
Page 99



Schluter®-VINPRO-STEP-R
Page 99

WATERPROOF SUBSTRATES & BUILDING PANELS



Schluter®-KERDI-BOARD
Page 101

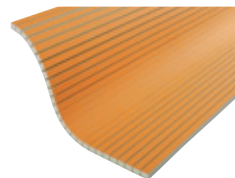

Schluter®-KERDI-BOARD-V
Page 102

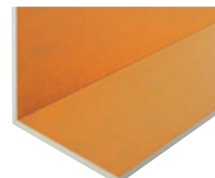

Schluter®-KERDI-BOARD-E
Page 102

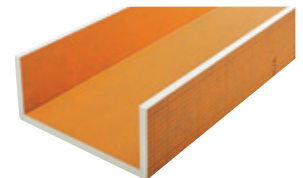

Schluter®-KERDI-BOARD-U
Page 102



Schluter®-KERDI-BOARD-SC
Page 103



Schluter®-KERDI-BOARD-SB
Page 103



Schluter®-KERDI-BOARD-SN
Page 104



Schluter®-KERDI-BOARD-ZC
Page 105

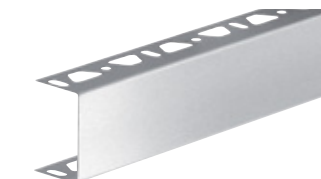

Schluter®-KERDI-BOARD-ZA
Page 105



Schluter®-KERDI-BOARD-ZB
Page 106



Schluter®-KERDI-BOARD-ZW
Page 106



Schluter®-KERDI-BOARD-ZSD
Page 106

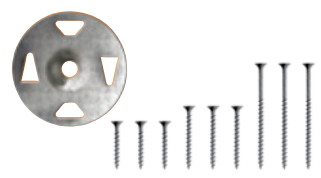

Schluter®-KERDI-BOARD-ZT/-ZS
Page 107



Schluter®-KERDI-BOARD-ZFP
Page 107



Schluter®-KERDI-BAND
Page 108

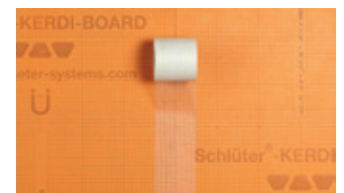

Schluter®-KERDI-BOARD-ZSA
Page 108



Schluter®-KERDI-BOARD-ZDK
Page 108



Schluter®-DITRA
Page 110



Schluter®-DITRA-XL
Page 110



Schluter®-DITRA-PS
Page 111



Schluter®-KERDI-FLEX
Page 111



Schluter®-KERDI-DS
Page 112



Schluter®-KERDI-BAND
Page 113

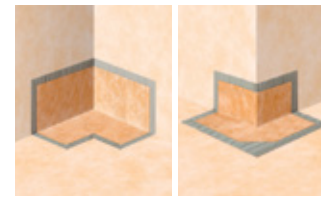

Schluter®-KERDI-KERECK-F
Page 113

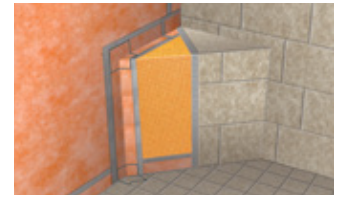

Schluter®-KERDI-KERS-B
Page 114

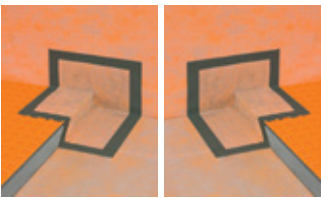

Schluter®-KERDI-KERS
Page 114

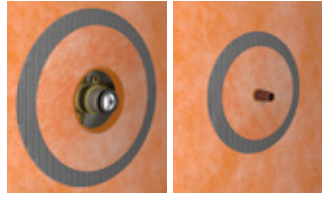

Schluter®-KERDI-SEAL-PS/-MV
Page 115

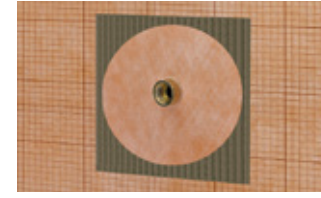

Schluter®-KERDI-KM
Page 115



Schluter®-KERDI-FIX
Page 115

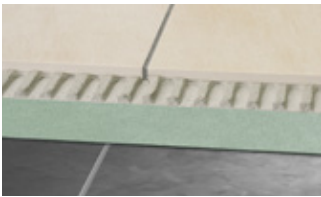

Schluter®-REFLEECE
Page 117

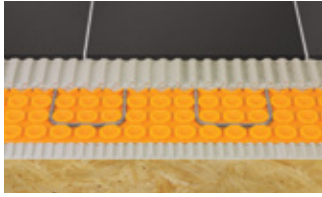

Schluter®-DITRA-HEAT
Page 119

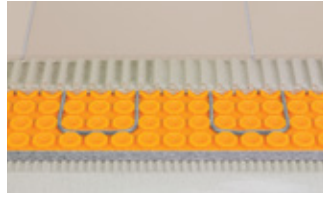

Schluter®-DITRA-HEAT-DUO
Page 119

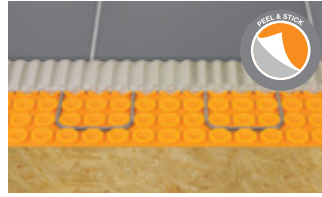

Schluter®-DITRA-HEAT-PS
Page 120

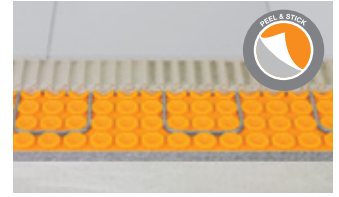

Schluter®-DITRA-HEAT-DUO-PS
Page 120



Schluter®-DITRA-HEAT-E-HK
Page 121



Schluter®-DITRA-HEAT-E-WIFI
Page 124



Schluter®-DITRA-HEAT-E-RT
Page 124



Schluter®-DITRA-HEAT-E-R
Page 124



Schluter®-DITRA-HEAT-E-RR
Page 124



Schluter®-DITRA-HEAT-E-RS1
Page 125

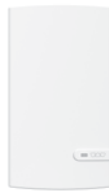

Schluter®-DITRA-HEAT-E-RRS
Page 125

SHOWER SYSTEM



Schluter®-KERDI-DS
Page 127



Schluter®-KERDI-BAND
Page 128

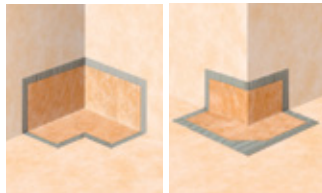

Schluter®-KERDI-KERECK-F
Page 128



Schluter®-KERDI-KERS-B
Page 129



Schluter®-KERDI-KERS
Page 129

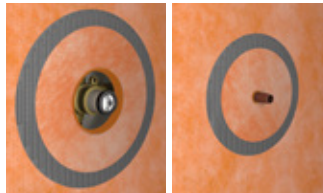

Schluter®-KERDI-SEAL-PS/-MV
Page 130



Schluter®-KERDI-KM
Page 130

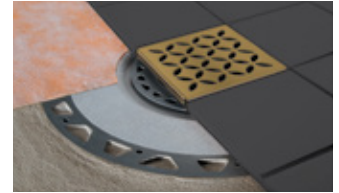

Schluter®-KERDI-DRAIN-A/-H
Page 132 - 142

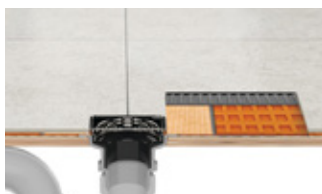

Schluter®-KERDI-DRAIN-F
Page 143

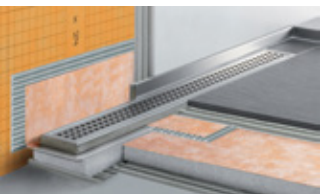

Schluter®-KERDI-LINE
Page 146 - 152



 Schluter®-KERDI-LINE-A
Page 152



Schluter®-KERDI-LINE-FC
Page 153



Schluter®-KERDI-LINE-VARIO
Page 154 - 156



Schluter®-KERDI-SHOWER-T/-TS/-TT
Page 158

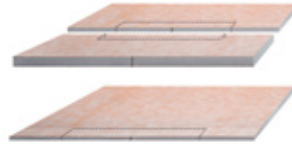

Schluter®-KERDI-SHOWER-LT/-LTS
Page 159



Schluter®-KERDI-SHOWER-CB
Page 160



Schluter®-KERDI-SHOWER-R
Page 160



Schluter®-KERDI-BOARD-SC
Page 160



Schluter®-KERDI-BOARD-SB
Page 161



Schluter®-KERDI-BOARD-SN
Page 161



Schluter®-KERDI-BOARD-SNLT
Page 163 - 164



Schluter®-LIPROTEC-ECX
Page 165



Schluter®-LIPROTEC-ECD
Page 165



Schluter®-LIPROTEC-CW
Page 165



Schluter®-DESIGN-NICHE
Page 166 - 167

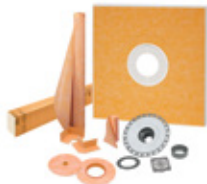

Schluter®-KERDI-SHOWER-KIT
Page 168 - 170



Schluter®-KERDI-TUBKIT
Page 171



Schluter®-KERDI-BOARD-KIT
Page 172



Schluter®-SHELF
Page 174 - 183



Schluter®-SHOWERPROFILE-S
Page 184



Schluter®-SHOWERPROFILE-R
Page 184



Schluter®-SHOWERPROFILE-WS
Page 185



Schluter®-SHOWERPROFILE-WSK
Page 185



Schluter®-DECO-SG
Page 186



Schluter®-DECO-SGC
Page 187



Schluter®-KERDI-FIX
Page 187

MODULAR SCREED SYSTEM FOR CONVENTIONAL & RADIANT-HEATED SCREEDS

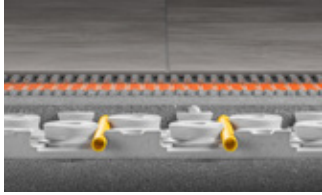

Schluter®-BEKOTEC
Page 189



Schluter®-BEKOTEC-F
Page 189



Schluter®-BEKOTEC-BRS
Page 190



Schluter®-BEKOTEC-BRSK
Page 190



Schluter®-BEKOTEC-BRS/KF
Page 190



Schluter®-BEKOTEC-BRS/KSF
Page 190

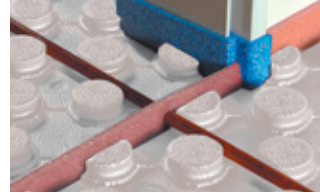

Schluter®-DILEX-DFP
Page 190



Schluter®-BEKOTEC-THERM-RH-75
190

SETTING MATERIALS



Schluter®-SET
Page 192



Schluter®-ALL-SET
Page 192



Schluter®-FAST-SET
Page 192



Schluter®-PRIMER-U
Page 194



 Schluter®-PRIMER-PS
Page 195



Schluter®-TROWEL
Page 196



Schluter®-DITRA Roller
Page 196



Schluter®-SNIPS
Page 197



Schluter®-PROCUT-TSM
Page 197



MANUFACTURING

The majority of Schluter® products sold in North America are also produced here.

In addition, products produced in North America are shipped overseas for worldwide distribution.

International cooperation in product development and support of the local economies are vital elements of our core strategy.



Schluter® Profiles

Transition & edge-protection profiles for floors

Transitions from a tiled floor to other surfaces need to be protected, and floor profiles are designed to ensure a smooth transition, while preventing tile edges from chipping and cracking. Schluter Systems offers a vast selection of floor profiles that protect tile edges between floor coverings at both equal and lower elevations.

Schluter floor profiles improve the integrity of the tile assembly, are maintenance-free, and are available in a variety of shapes, sizes, materials, and finishes to complement the design of any room.



RENO-U (page 23)



Schluter®-SCHIENE

The Original Since 1975

For 50 years, tile professionals have relied on the Schluter-SCHIENE to securely protect the results of their work. Developed from practical experience by master tiler Werner Schlüter in 1975, our best-known product still offers superior edge protection today, thanks to its special design features:

- 1 87° angle from the anchoring leg for optimal load transfer
- 2 Coved channel for high strength and resistance to bending
- 3 Reinforced top section with 5° angle
- 4 Patented, integrated joint spacer

The details make the difference!

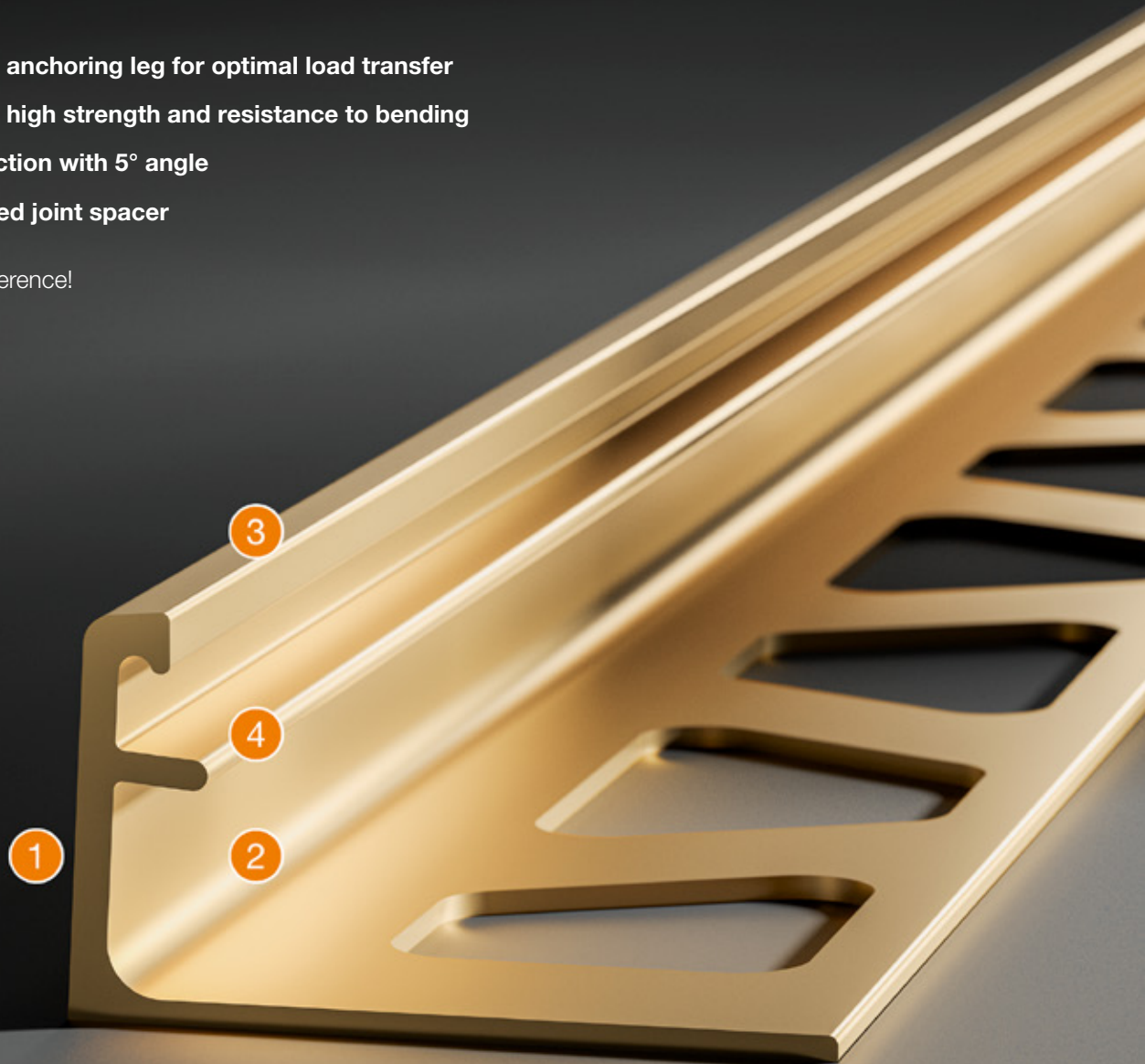



Schluter®-SCHIENE

Schluter®-SCHIENE features an 87° angle to transfer point loads and protect tile edges in tile coverings. Typical applications include edge protection where tile is bordered by carpet, at expansion joints, or as a decorative edging for stairs. SCHIENE in aluminum and brass, in sizes 1/4" (6 mm) and higher, features an integrated joint spacer that establishes a defined joint cavity between the tile and the profile.

Note: Also available in stainless steel 316L (1.4404 = V4A). Contact Customer Service for pricing and availability.

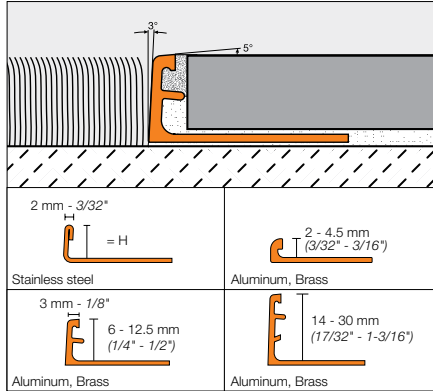

Schluter®-SCHIENE										
Length = 2.5 m - 8' 2-1/2"	Stainless steel 304 (1.4301 = V2A) (E)		Brushed stainless steel 304 (1.4301 = V2A) (EB)		Solid brass (M)*		Aluminum (A)		Satin anodized aluminum (AE)	
H = mm - in.	Item No.	\$ / Length	Item No.	\$ / Length	Item No.	\$ / Length	Item No.	\$ / Length	Item No.	\$ / Length
2 - 3/32	E 20	27.98	-	-	-	-	A 20	9.09	AE 20	13.90
3 - 1/8	E 30	30.77	-	-	M 30	29.38	A 30	9.53	AE 30	14.55
4.5 - 3/16	E 45	36.39	-	-	M 45	32.90	A 45	9.75	AE 45	14.91
6 - 1/4	E 60	37.10	E 60 EB	44.51	M 60	34.28	A 60	10.42	AE 60	15.56
7 - 9/32	E 70	37.80	-	-	-	-	A 70	10.60	AE 70	15.87
8 - 5/16	E 80	37.35	E 80 EB	46.20	M 80	37.77	A 80	10.47	AE 80	15.45
9 - 11/32	E 90	39.72	-	-	M 90	38.20	A 90	11.14	AE 90	16.75
10 - 3/8	E 100	39.41	E 100 EB	48.71	M 100	38.62	A 100	11.01	AE 100	16.39
11 - 7/16	E 110	40.01	E 110 EB	50.35	M 110	39.62	A 110	11.38	AE 110	17.46
12.5 - 1/2	E 125	40.75	E 125 EB	50.39	M 125	40.04	A 125	11.58	AE 125	17.57
14 - 17/32	E 140	43.72	-	-	-	-	A 140	13.68	AE 140	19.59
15 - 9/16	E 150	48.98	-	-	M 150	44.93	A 150	14.32	AE 150	19.81
16 - 5/8	E 160	49.97	-	-	M 160	45.22	A 160	14.73	AE 160	21.48
17.5 - 11/16	E 175	50.40	-	-	M 175	46.04	A 175	15.64	AE 175	22.73
20 - 3/4	E 200	52.48	-	-	M 200	47.03	A 200	16.29	AE 200	24.64
21 - 13/16	-	-	-	-	-	-	A 210	16.93	AE 210	25.28
22.5 - 7/8	E 225	54.60	-	-	M 225	57.39	A 225	17.34	AE 225	25.92
25 - 1	E 250	56.68	-	-	M 250	58.51	A 250	18.21	AE 250	27.17
27.5 - 1-1/16	-	-	-	-	-	-	A 275	18.89	AE 275	29.06
30 - 1-3/16	E 300	60.90	-	-	M 300	63.67	A 300	20.19	AE 300	30.31

10-foot (3.05 m) SCHIENE Profiles – Stainless Steel

Length = 3.05 m - 10'	Stainless steel 304 (1.4301 = V2A) (E)	
H = mm - in.	Profile	\$ / Length
8 - 5/16	E 80 / 300	46.69
10 - 3/8	E 100 / 300	49.27
12.5 - 1/2	E 125 / 300	50.95

Special shipping conditions apply, see pages 207 - 208.

Note: The anchoring leg of Schluter®-SCHIENE is available with a special radius perforation so that the profile can be used to form curves.

- Price surcharge: \$0.70 per foot
- Available in all materials
- Item No.: R / Profile No. (e.g., R/M 80)
- For delivery time, please call Customer Service



* ⚠️ **WARNING:** Reproductive Harm - www.P65Warnings.ca.gov



Schluter®-SCHIENE								
Length = 2.5 m - 8' 2-1/2"	Polished chrome anodized aluminum (ACG)		Brushed chrome anodized aluminum (ACGB)		Satin nickel anodized aluminum (AT)		Polished nickel anodized aluminum (ATG)	
H = mm - in.	Item No.	\$ / Length	Item No.	\$ / Length	Item No.	\$ / Length	Item No.	\$ / Length
6 - 1/4	A 60 ACG	18.18	A 60 ACGB	19.43	A 60 AT	18.49	A 60 ATG	23.93
8 - 5/16	A 80 ACG	19.43	A 80 ACGB	19.96	A 80 AT	18.88	A 80 ATG	24.30
10 - 3/8	A 100 ACG	21.50	A 100 ACGB	22.08	A 100 AT	19.24	A 100 ATG	24.95
12.5 - 1/2	A 125 ACG	22.74	A 125 ACGB	23.31	A 125 AT	19.88	A 125 ATG	25.16

Length = 2.5 m - 8' 2-1/2"	Brushed nickel anodized aluminum (ATGB)		Satin copper anodized aluminum (AK)		Polished copper anodized aluminum (AKG)		Brushed copper anodized aluminum (AKGB)	
H = mm - in.	Item No.	\$ / Length	Item No.	\$ / Length	Item No.	\$ / Length	Item No.	\$ / Length
6 - 1/4	A 60 ATGB	21.48	A 60 AK	18.49	A 60 AKG	23.93	A 60 AKGB	21.48
8 - 5/16	A 80 ATGB	21.73	A 80 AK	19.24	A 80 AKG	24.30	A 80 AKGB	22.16
10 - 3/8	A 100 ATGB	22.19	A 100 AK	19.62	A 100 AKG	24.95	A 100 AKGB	22.62
12.5 - 1/2	A 125 ATGB	23.16	A 125 AK	20.26	A 125 AKG	25.16	A 125 AKGB	23.16

Length = 2.5 m - 8' 2-1/2"	Satin brass anodized aluminum (AM)		Polished brass anodized aluminum (AMG)		Brushed brass anodized aluminum (AMGB)		Brushed antique bronze anodized aluminum (ABGB)	
H = mm - in.	Item No.	\$ / Length	Item No.	\$ / Length	Item No.	\$ / Length	Item No.	\$ / Length
6 - 1/4	A 60 AM	15.51	A 60 AMG	18.18	A 60 AMGB	20.67	A 60 ABGB	22.95
8 - 5/16	A 80 AM	16.12	A 80 AMG	19.43	A 80 AMGB	21.38	A 80 ABGB	24.14
10 - 3/8	A 100 AM	17.98	A 100 AMG	21.91	A 100 AMGB	22.94	A 100 ABGB	24.87
12.5 - 1/2	A 125 AM	19.21	A 125 AMG	23.18	A 125 AMGB	24.16	A 125 ABGB	26.94

10-foot (3.05 m) SCHIENE Profiles – Anodized Aluminum								
Length = 3.05 m - 10'	Satin anodized aluminum (AE)		Polished chrome anodized aluminum (ACG)		Satin nickel anodized aluminum (AT)		Brushed antique bronze anodized aluminum (ABGB)	
H = mm - in.	Item No.	\$ / Length	Item No.	\$ / Length	Item No.	\$ / Length	Item No.	\$ / Length
8 - 5/16	AE 80 / 300	19.32	A 80 ACG / 300	24.29	A 80 AT / 300	23.61	A 80 ABGB / 300	30.18
10 - 3/8	AE 100 / 300	20.49	A 100 ACG / 300	26.86	A 100 AT / 300	24.06	A 100 ABGB / 300	31.10
12.5 - 1/2	AE 125 / 300	21.97	A 125 ACG / 300	28.41	A 125 AT / 300	24.85	A 125 ABGB / 300	33.67

Special shipping conditions apply, see pages 207 - 208.



Schluter®-TRENDLINE Textured Color-coated Aluminum

Matte White and Matte Black

Schluter®-SCHIENE			
Length = 2.5 m - 8' 2-1/2"		Textured color-coated aluminum (TS)	
H = mm - in.	Item No.	\$ / Length	
6 - 1/4	A 60 + color*	32.72	
8 - 5/16	A 80 + color*	33.45	
10 - 3/8	A 100 + color*	34.10	
11 - 7/16	A 110 + color*	34.45	
12.5 - 1/2	A 125 + color*	35.13	

Schluter®-SCHIENE			
Length = 2.5 m - 8' 2-1/2"		Matte color-coated aluminum	
H = mm - in.	Item No.	\$ / Length	
3 - 1/8	A 30 + color*	25.15	
4.5 - 3/16	A 45 + color*	25.65	
6 - 1/4	A 60 + color*	26.18	
8 - 5/16	A 80 + color*	26.75	
10 - 3/8	A 100 + color*	27.27	
11 - 7/16	A 110 + color*	27.56	
12.5 - 1/2	A 125 + color*	28.11	

*Color Codes



* To complete the item number, add the color code (e.g., A 60 TSC).

*Color Codes



* To complete the item number, add the color code (e.g., A 60 MGS).

Note: The anchoring leg of Schluter®-SCHIENE is available with a special radius perforation so that the profile can be used to form curves.



- Price surcharge: \$0.70 per foot
- Available in all materials
- Polished and color-coated aluminum finishes require a relatively large bending radius
- Item No.: R / Profile No. (e.g., R/A 80 AT)
- For delivery time, please call Customer Service



SCHIENE in textured color-coated aluminum finishes is suitable for floor installations within residential applications only.

Schluter®-SCHIENE-RADIUS

Schluter®-SCHIENE-RADIUS is an extruded profile, with special perforations, for finishing and protecting the edges of curved tile coverings. SCHIENE-RADIUS provides edge protection while enhancing the aesthetic appearance of a curved design, including curved tile-to-tile transitions and curved outside wall corners, as well as curved designs in other surface coverings. Other sizes are available upon request.

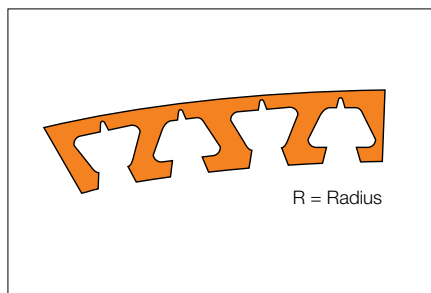

Schluter®-SCHIENE-RADIUS

Length = 2.5 m - 8' 2-1/2"	Stainless steel 304 (1.4301 = V2A) (E)		Solid brass (M)*		Aluminum (A)		Satin anodized aluminum (AE)	
	Item No.	\$ / Length	Item No.	\$ / Length	Item No.	\$ / Length	Item No.	\$ / Length
H = mm - in.								
6 - 1/4	R/E 60	42.70	R/M 60	39.88	R/A 60	16.02	R/AE 60	21.16
8 - 5/16	R/E 80	42.95	R/M 80	43.37	R/A 80	16.07	R/AE 80	21.05
10 - 3/8	R/E 100	45.01	R/M 100	44.22	R/A 100	16.61	R/AE 100	21.99
12.5 - 1/2	R/E 125	46.35	R/M 125	45.64	R/A 125	17.18	R/AE 125	23.17

* ⚠ WARNING: Reproductive Harm - www.P65Warnings.ca.gov



Schluter®-DECO

Schluter®-DECO is designed to provide decorative lines within tile coverings and edge protection at transitions from tile coverings to other same-height surface coverings such as wood or carpet. The profile features a 1/4" (6 mm)-wide visible surface.

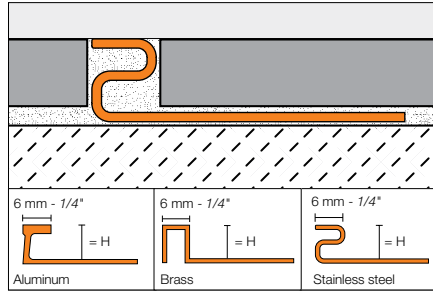

Schluter®-DECO								
Length = 2.5 m - 8' 2-1/2"	Stainless steel 304 (1.4301 = V2A) (E)		Solid brass (M)*		Chrome-plated solid brass (MC)*		Satin anodized aluminum (AE)	
H = mm - in.	Item No.	\$ / Length	Item No.	\$ / Length	Item No.	\$ / Length	Item No.	\$ / Length
8 - 5/16	E 80 D	47.26	-	-	-	-	AE 80 D	22.58
9 - 11/32	E 90 D	47.86	M 90 D	90.64	MC 90 D	197.52	-	-
10 - 3/8	E 100 D	48.58	-	-	-	-	AE 100 D	25.46
11 - 7/16	E 110 D	49.20	M 110 D	97.49	MC 110 D	204.53	-	-
12.5 - 1/2	E 125 D	50.38	M 125 D	102.20	MC 125 D	209.24	AE 125 D	26.29
14 - 17/32	E 140 D	51.14	-	-	-	-	-	-
16 - 5/8	E 160 D	52.77	-	-	-	-	-	-
18.5 - 23/32	E 185 D	54.56	-	-	-	-	-	-
21 - 13/16	E 210 D	56.21	-	-	-	-	-	-
25 - 1	E 250 D	59.33	-	-	-	-	-	-
30 - 1-3/16	E 300 D	62.60	-	-	-	-	-	-

Note: The anchoring leg of **Schluter®-DECO** is available with a special radius perforation so that the profile can be used to form curves.

- Price surcharge: \$0.70 per foot
- Available in all materials except stainless steel and chrome-plated solid brass
- Item No.: R / Profile No. (e.g., R/M 90 D)
- For delivery time, please call Customer Service



* **WARNING:** Reproductive Harm - www.P65Warnings.ca.gov



Schluter®-RENO-T

Schluter®-RENO-T is designed to provide transitions between existing, same-height, hard surface floor coverings, primarily in retrofit applications (e.g., ceramic tile or natural stone, parquet flooring, concrete pavers, laminate, etc.). RENO-T, in brass and anodized aluminum size 9/14, is flexible in the lateral direction and can be used in curved applications.

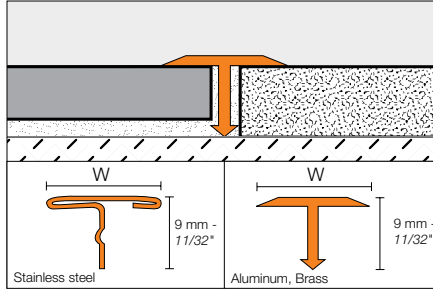

Schluter®-RENO-T

Length = 2.5 m - 8' 2-1/2"	Stainless steel 304 (1.4301 = V2A) (E)		Brushed stainless steel 304 (1.4301 = V2A) (EB)		Solid brass (M)*		Satin anodized aluminum (AE)	
W = mm - in.	Item No.	\$ / Length	Item No.	\$ / Length	Item No.	\$ / Length	Item No.	\$ / Length
14 - 17/32	T 9/14 E	35.82	T 9/14 EB	38.12	T 9/14 M	24.42	T 9/14 AE	12.68
25 - 1	T 9/25 E	48.99	T 9/25 EB	53.53	T 9/25 M	41.39	T 9/25 AE	20.49

Length = 2.5 m - 8' 2-1/2"	Satin nickel anodized aluminum (AT)		Satin copper anodized aluminum (AK)		Satin brass anodized aluminum (AM)	
W = mm - in.	Item No.	\$ / Length	Item No.	\$ / Length	Item No.	\$ / Length
14 - 17/32	T 9/14 AT	14.83	T 9/14 AK	15.14	T 9/14 AM	13.71
25 - 1	T 9/25 AT	24.67	T 9/25 AK	24.67	T 9/25 AM	20.86

* **WARNING:** Reproductive Harm - www.P65Warnings.ca.gov



Schluter®-RENO-TK

Schluter®-RENO-TK is designed to protect tile edges and provide a smooth transition from tile coverings to floor coverings at lower elevations, typically carpet. The 1/4" (6 mm) channel beneath the sloped flange of the profile hides and protects the cut edge of lower adjoining surface coverings. RENO-TK in anodized aluminum sizes 5/16" (8 mm) and larger features an integrated joint spacer that establishes a defined joint cavity between the tile and the profile.

ADA-Compliant

Technical Note: ADA requirements regarding transitions between surfaces of different heights:

- Up to 6 mm (1/4") - no special requirements
- 6 mm (1/4") to 12.5 mm (1/2") - slope ratio, 1:2
- More than 12.5 mm (1/2") - slope ratio, 1:12

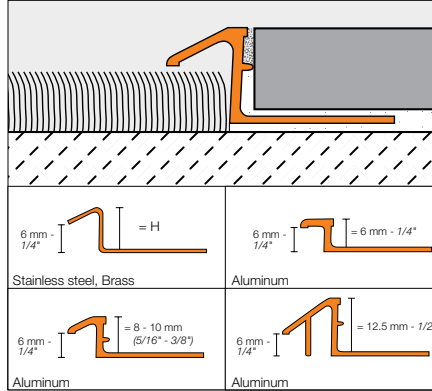

Diagram Values		
H = mm - in.	B = mm - in.	
	Aluminum	Stainless steel/Brass
6 - 1/4	7.5 - 19/64	-
8 - 5/16	8.5 - 21/64	7 - 9/32
10 - 3/8	8.5 - 21/64	11 - 7/16
11 - 7/16	-	13.5 - 17/32
12.5 - 1/2	15.5 - 39/64	16.5 - 21/32

Schluter®-RENO-TK								
Length = 2.5 m - 8' 2-1/2"	Stainless steel 304 (1.4301 = V2A) (E)		Brushed stainless steel 304 (1.4301 = V2A) (EB)		Solid brass (M)*		Satin anodized aluminum (AE)	
H = mm - in.	Item No.	\$ / Length	Item No.	\$ / Length	Item No.	\$ / Length	Item No.	\$ / Length
6 - 1/4	-	-	-	-	-	-	AETK 60	19.08
8 - 5/16	ETK 80	53.21	EBTK 80	69.20	MTK 80	44.15	AETK 80	20.49
10 - 3/8	ETK 100	58.18	EBTK 100	75.64	MTK 100	47.87	AETK 100	21.90
11 - 7/16	ETK 110	62.89	EBTK 110	77.89	-	-	-	-
12.5 - 1/2	ETK 125	64.59	EBTK 125	80.72	MTK 125	64.84	AETK 125	28.23

Length = 2.5 m - 8' 2-1/2"	Bright chrome anod. alu. (ACB)		Satin nickel anod. alu. (AT)		Brushed nickel anod. alu. (ATGB)		Brushed antique bronze anod. alu. (ABGB)	
H = mm - in.	Item No.	\$ / Length	Item No.	\$ / Length	Item No.	\$ / Length	Item No.	\$ / Length
6 - 1/4	ATK 60 ACB	20.49	ATK 60 AT	21.90	-	-	-	-
8 - 5/16	ATK 80 ACB	21.90	ATK 80 AT	23.33	ATK 80 ATGB	30.09	ATK 80 ABGB	30.09
10 - 3/8	ATK 100 ACB	23.33	ATK 100 AT	28.23	ATK 100 ATGB	32.61	ATK 100 ABGB	32.61
12.5 - 1/2	ATK 125 ACB	30.38	ATK 125 AT	31.79	ATK 125 ATGB	39.59	ATK 125 ABGB	39.59

Note: The anchoring leg of **Schluter®-RENO-TK** is available with a special radius perforation so that the profile can be used to form curves.

- Price surcharge: \$0.70 per foot
- Available in all materials except stainless steel
- Bright/polished finishes require a relatively large bending radius
- Item No.: R / Profile No. (e.g., R/ATK 100 ACB)
- For delivery time, please call Customer Service



* **WARNING:** Reproductive Harm - www.P65Warnings.ca.gov



Schluter®-RENO-V

Schluter®-RENO-V is designed to protect tile edges and provide a smooth transition between tile coverings and floor coverings at lower elevations. The profile features a movable transition arm that allows the profile to adjust to the height of the adjacent floor covering via a ball-and-socket joint and eliminates trip hazards. RENO-V features an integrated joint spacer that establishes a defined joint cavity between the tile and the profile.

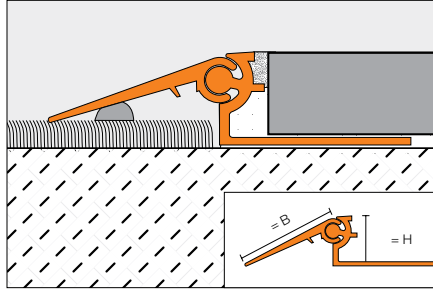

B = 20 mm - 3/4", 30 mm - 1-3/16", 40 mm - 1-9/16"

Schluter®-RENO-V			
Length = 2.5 m - 8' 2-1/2"	Satin anodized aluminum (AE)		
H = mm - in.	Item No.	\$/ Length	
B = 20 mm - 3/4"			
8 - 5/16	AEVT 80 B20	58.37	
10 - 3/8	AEVT 100 B20	59.81	
12.5 - 1/2	AEVT 125 B20	61.25	
15 - 9/16	AEVT 150 B20	63.38	
17.5 - 11/16	AEVT 175 B20	64.83	
20 - 3/4	AEVT 200 B20	69.90	
B = 30 mm - 1-3/16"			
8 - 5/16	AEVT 80 B30	64.83	
10 - 3/8	AEVT 100 B30	66.25	
12.5 - 1/2	AEVT 125 B30	67.01	
15 - 9/16	AEVT 150 B30	68.47	
17.5 - 11/16	AEVT 175 B30	69.90	
20 - 3/4	AEVT 200 B30	74.93	
B = 40 mm - 1-9/16"			
8 - 5/16	AEVT 80 B40	71.33	
10 - 3/8	AEVT 100 B40	72.78	
12.5 - 1/2	AEVT 125 B40	74.63	
15 - 9/16	AEVT 150 B40	76.37	
17.5 - 11/16	AEVT 175 B40	77.83	
20 - 3/4	AEVT 200 B40	82.86	

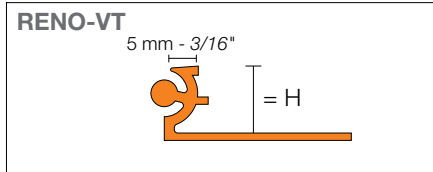

Schluter®-RENO-VT			
Support profile			
Length = 2.5 m - 8' 2-1/2"	Satin anodized aluminum (AE)		
H = mm - in.	Item No.	\$/ Length	
8 - 5/16	AEVT 80	26.88	
10 - 3/8	AEVT 100	28.10	
12.5 - 1/2	AEVT 125	29.58	
15 - 9/16	AEVT 150	31.16	
17.5 - 11/16	AEVT 175	32.65	
20 - 3/4	AEVT 200	36.92	

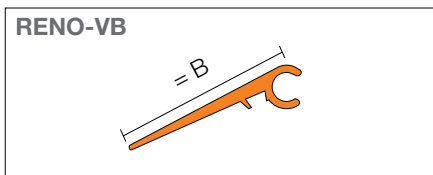

Schluter®-RENO-VB			
Variable transition arm			
Length = 2.5 m - 8' 2-1/2"	Satin anodized aluminum (AE)		
B = mm - in.	Item No.	\$/ Length	
20 - 3/4	AEVB 20	26.09	
30 - 1-3/16	AEVB 30	30.09	
40 - 1-9/16	AEVB 40	37.46	



Schluter®-RENO-RAMP/-K

Schluter®-RENO-RAMP/-K are designed to protect tile edges and provide a smooth transition between tile coverings and floor coverings at lower elevations or finished concrete. The sloped surface eliminates trip hazards and allows easy access for wheel carts. RENO-RAMP/-K feature an integrated joint spacer that establishes a defined joint cavity between the tile and the profile.

RENO-RAMP has an anchoring leg which is embedded in the tile bond coat.

RENO-RAMP-K is subsequently bonded adjacent to existing floor coverings.

ADA-Compliant

Note: 15 mm (9/16") and 20 mm (3/4") are not ADA-compliant.

Technical Note: ADA requirements regarding transitions between surfaces of different heights:

- Up to 6 mm (1/4") - no special requirements
- 6 mm (1/4") to 12.5 mm (1/2") - slope ratio, 1:2
- More than 12.5 mm (1/2") - slope ratio, 1:12

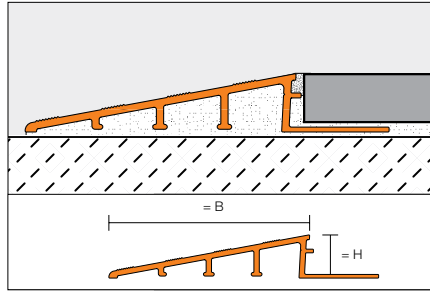

B= 50 mm - 2", 64 mm - 2-1/2", 89 mm - 3-1/2"



Diagram Values

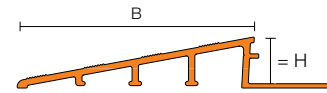

H = mm - in.	B = mm - in.
6 - 1/4	50 - 2
10 - 3/8	64 - 2-1/2
12.5 - 1/2	64 - 2-1/2
12.5 - 1/2	89 - 3-1/2
15 - 9/16	89 - 3-1/2
20 - 3/4	89 - 3-1/2

Schluter®-RENO-RAMP

Length = 2.5 m - 8' 2-1/2"	Satin anodized aluminum (AE)	
H = mm - in.	Item No.	\$ / Length
B = 50 mm - 2"		
6 - 1/4	AERP 60 B50	50.58
B = 64 mm - 2-1/2"		
10 - 3/8	AERP 100 B65	50.93
12.5 - 1/2	AERP 125 B65	53.11
B = 89 mm - 3-1/2"		
12.5 - 1/2	AERP 125 B90	68.40
15 - 9/16	AERP 150 B90	70.59
20 - 3/4	AERP 200 B90	74.19

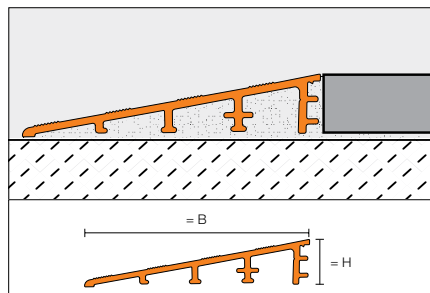

B= 64 mm - 2-1/2"



Schluter®-RENO-RAMP-K

Length = 2.5 m - 8' 2-1/2"	Satin anodized aluminum (AE)	
H = mm - in.	Item No.	\$ / Length
B = 64 mm - 2-1/2"		
12.5 - 1/2	AERPK 125 B65	62.07



Schluter®-RENO-U

Schluter®-RENO-U is designed to protect tile edges and provide a smooth transition between tile coverings and floor coverings at lower elevations or finished concrete. The sloped surface eliminates trip hazards and the leading edge of the profile abuts the lower surface covering. RENO-U in anodized aluminum features an integrated joint spacer that establishes a defined joint cavity between the tile and the profile.

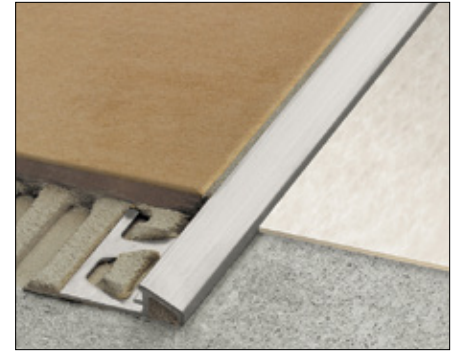
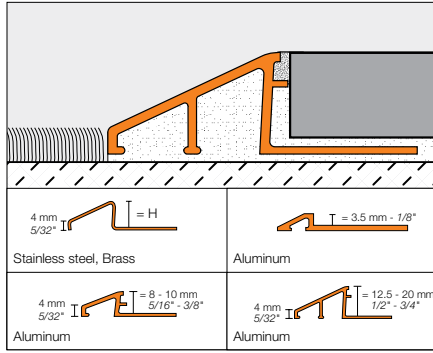

ADA-Compliant

Note: When leading edge abuts lower surface covering, sizes 20 mm (3/4") and 17.5 mm (11/16") are not ADA-compliant. When leading edge rests on top of lower surface covering, sizes 20 mm (3/4"), 15 mm (9/16"), and 17.5 mm (11/16") are not ADA-compliant.

Technical Note: ADA requirements regarding transitions between surfaces of different heights:

- Up to 6 mm (1/4") - no special requirements
- 6 mm (1/4") to 12.5 mm (1/2") - slope ratio, 1:2
- More than 12.5 mm (1/2") - slope ratio, 1:12

Diagram Values

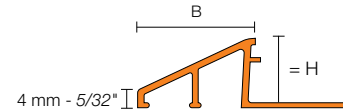

H = mm - in.	B = mm - in.	
	Aluminum	Stainless steel/Brass
3.5 - 1/8	9 - 23/64	-
8 - 5/16	12.5 - 31/64	13 - 33/64
10 - 3/8	16.5 - 21/32	17.5 - 11/16
11 - 7/16	-	19.5 - 49/64
12.5 - 1/2	22 - 55/64	23 - 29/32
15 - 9/16	27.5 - 1-5/64	28 - 1-7/64
17.5 - 11/16	27 - 1-1/16	33.5 - 1-5/16
20 - 3/4	-	40 - 1-37/64

Schluter®-RENO-U								
Length = 2.5 m - 8' 2-1/2"	Stainless steel 304 (1.4301 = V2A) (E)		Brushed stainless steel 304 (1.4301 = V2A) (EB)		Solid brass (M)*		Satin anodized aluminum (AE)	
H = mm - in.	Item No.	\$ / Length	Item No.	\$ / Length	Item No.	\$ / Length	Item No.	\$ / Length
3.5 - 1/8	-	-	-	-	-	-	AEU 35	16.39
8 - 5/16	EU 80	54.83	EBU 80	84.65	MU 80	59.05	AEU 80	19.76
10 - 3/8	EU 100	59.95	EBU 100	89.93	MU 100	66.32	AEU 100	20.78
11 - 7/16	EU 110	64.94	EBU 110	92.98	-	-	-	-
12.5 - 1/2	EU 125	66.51	EBU 125	96.78	MU 125	83.21	AEU 125	27.57
15 - 9/16	EU 150	72.38	EBU 150	102.50	MU 150	92.29	AEU 150	35.31
17.5 - 11/16	EU 175	79.59	EBU 175	109.64	-	-	AEU 175	42.95
20 - 3/4	EU 200	87.59	EBU 200	117.33	-	-	-	-

Length = 2.5 m - 8' 2-1/2"	Bright chrome anod. alu. (ACB)		Satin nickel anod. alu. (AT)		Brushed nickel anod. alu. (ATGB)	
H = mm - in.	Item No.	\$ / Length	Item No.	\$ / Length	Item No.	\$ / Length
8 - 5/16	AU 80 ACB	21.61	AU 80 AT	21.26	AU 80 ATGB	35.06
10 - 3/8	AU 100 ACB	25.21	AU 100 AT	22.34	AU 100 ATGB	38.51
12.5 - 1/2	AU 125 ACB	32.43	AU 125 AT	28.80	AU 125 ATGB	46.47

Length = 2.5 m - 8' 2-1/2"	Brushed antique bronze anod. alu. (ABGB)		Satin brass anod. alu. (AM)	
H = mm - in.	Item No.	\$ / Length	Item No.	\$ / Length
8 - 5/16	AU 80 ABGB	35.06	AU 80 AM	21.26
10 - 3/8	AU 100 ABGB	38.51	AU 100 AM	22.34
12.5 - 1/2	AU 125 ABGB	46.47	AU 125 AM	28.80

* **WARNING:** Reproductive Harm - www.P65Warnings.ca.gov



Schluter® Profiles

Finishing & edge-protection profiles for walls & countertops

From framing a shower niche to accentuating a fireplace surround, Schluter profiles add the perfect finishing touch to tiled walls as they conceal and protect exposed tile edges and eliminate the need for unsightly caulking. The assortment of available accessories eliminate the need for mitering, expedite installation time, and provide a nice, clean finish.

Resistant to staining, scratching, and high heat, tiled countertops require no maintenance and are easy to clean with standard household products. Cover the subassembly using a profile with a wide reveal, or frame a designated area for bonding accent tile. Do-away with caulking around the sink and bring the elegance of your tile installation to the next level.



Backsplash trim: QUADEC in bright white (page 42)
Counter trim: RONDEC-STEP in brushed chrome (page 51)



Schluter®-JOLLY

Schluter®-JOLLY is a decorative profile featuring a 90° angle designed to finish and protect external corners and other tile edges in wall applications. Its 90° angle creates a clean, flush look on wall corner installations, and the joint spacers on both sides of the profile ensure consistent grout joints and perfect symmetry. Matching corners are available, which feature innovative plug-in connections that result in clean, visually appealing corner applications.

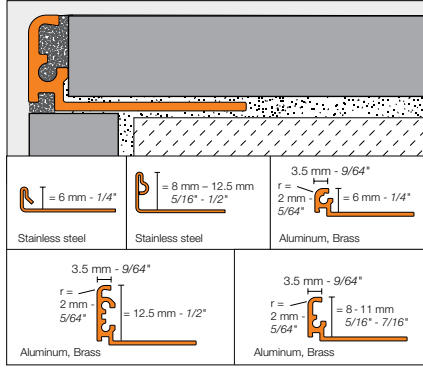

Stainless Steel

Schluter®-JOLLY				
Length = 2.5 m - 8' 2-1/2"	Brushed stainless steel 304 (1.4301 = V2A) (EB)			
H = mm - in.	Profile	\$ / Length	Outside corner	\$ / Unit
6 - 1/4	J 60 EB	44.51	EV / J 60 EB	21.93
8 - 5/16	J 80 EB	46.20	EV / J 80 EB	21.93
10 - 3/8	J 100 EB	48.71	EV / J 100 EB	21.93
11 - 7/16	J 110 EB	50.35	EV / J 110 EB	21.93
12.5 - 1/2	J 125 EB	50.39	EV / J 125 EB	21.93

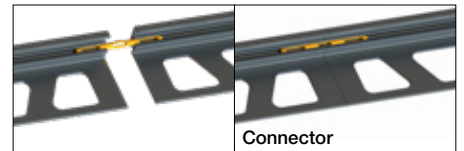
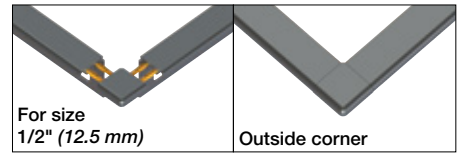
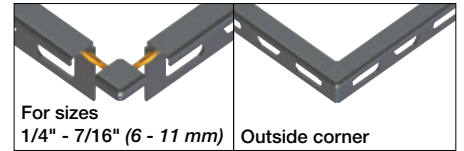

Brass

Schluter®-JOLLY				
Length = 2.5 m - 8' 2-1/2"	Chrome-plated solid brass (MC) *			
H = mm - in.	Profile	\$ / Length	Outside corner	\$ / Unit
6 - 1/4	J 60 MC	88.05	EV / J 60 MC	20.98
8 - 5/16	J 80 MC	91.12	EV / J 80 MC	20.98
10 - 3/8	J 100 MC	92.30	EV / J 100 MC	20.98
11 - 7/16	J 110 MC	93.22	EV / J 110 MC	20.98
12.5 - 1/2	J 125 MC	93.84	EV / J 125 MC	20.98

Notes:

- Corners in sizes 6 to 11 mm (1/4" to 7/16") include 4 plug-in connectors.
- Corners in size 12.5 mm (1/2") include 8 plug-in connectors.

Connector	Quantity	\$ / Pkg.
V / J PP4	4	2.77



Note: The anchoring leg of **Schluter®-JOLLY** is available with a special radius perforation so that the profile can be used to form curves.

- Price surcharge: \$0.70 per foot
- Chrome-plated brass requires a relatively large bending radius
- Item No.: R / Profile No. (e.g., R/J 60 EB)
- For delivery time, please call Customer Service



* **WARNING:** Reproductive Harm - www.P65Warnings.ca.gov



Anodized Aluminum

Schluter®-JOLLY								
Length = 2.5 m - 8' 2-1/2"	Satin anodized aluminum (AE)				Polished chrome anodized aluminum (ACG)			
H = mm - in.	Profile	\$/ Length	Outside corner	\$/ Unit	Profile	\$/ Length	Outside corner	\$/ Unit
6 - 1/4	J 60 AE	15.87	EV / J 60 AE	8.36	J 60 ACG	18.54	EV / J 60 ACG	10.94
8 - 5/16	J 80 AE	15.76	EV / J 80 AE	8.36	J 80 ACG	19.82	EV / J 80 ACG	10.94
10 - 3/8	J 100 AE	16.72	EV / J 100 AE	8.36	J 100 ACG	21.93	EV / J 100 ACG	10.94
11 - 7/16	J 110 AE	17.81	EV / J 110 AE	8.36	J 110 ACG	22.14	EV / J 110 ACG	10.94
12.5 - 1/2	J 125 AE	17.92	EV / J 125 AE	8.36	J 125 ACG	23.19	EV / J 125 ACG	10.94

Length = 2.5 m - 8' 2-1/2"	Brushed chrome anodized aluminum (ACGB)				Satin nickel anodized aluminum (AT)			
H = mm - in.	Profile	\$/ Length	Outside corner	\$/ Unit	Profile	\$/ Length	Outside corner	\$/ Unit
6 - 1/4	J 60 ACGB	19.82	EV / J 60 ACGB	10.94	J 60 AT	18.86	EV / J 60 AT	10.94
8 - 5/16	J 80 ACGB	20.36	EV / J 80 ACGB	10.94	J 80 AT	19.26	EV / J 80 AT	10.94
10 - 3/8	J 100 ACGB	22.52	EV / J 100 ACGB	10.94	J 100 AT	19.62	EV / J 100 AT	10.94
11 - 7/16	J 110 ACGB	22.97	EV / J 110 ACGB	10.94	J 110 AT	19.82	EV / J 110 AT	10.94
12.5 - 1/2	J 125 ACGB	23.78	EV / J 125 ACGB	10.94	J 125 AT	20.28	EV / J 125 AT	10.94

Length = 2.5 m - 8' 2-1/2"	Polished nickel anodized aluminum (ATG)				Brushed nickel anodized aluminum (ATGB)			
H = mm - in.	Profile	\$/ Length	Outside corner	\$/ Unit	Profile	\$/ Length	Outside corner	\$/ Unit
6 - 1/4	J 60 ATG	24.41	EV / J 60 ATG	10.94	J 60 ATGB	21.91	EV / J 60 ATGB	10.94
8 - 5/16	J 80 ATG	24.79	EV / J 80 ATG	10.94	J 80 ATGB	22.16	EV / J 80 ATGB	10.94
10 - 3/8	J 100 ATG	25.45	EV / J 100 ATG	10.94	J 100 ATGB	22.63	EV / J 100 ATGB	10.94
11 - 7/16	J 110 ATG	25.57	EV / J 110 ATG	10.94	J 110 ATGB	22.86	EV / J 110 ATGB	10.94
12.5 - 1/2	J 125 ATG	25.66	EV / J 125 ATG	10.94	J 125 ATGB	23.62	EV / J 125 ATGB	10.94

Length = 2.5 m - 8' 2-1/2"	Satin copper anodized aluminum (AK)				Polished copper anodized aluminum (AKG)			
H = mm - in.	Profile	\$/ Length	Outside corner	\$/ Unit	Profile	\$/ Length	Outside corner	\$/ Unit
6 - 1/4	J 60 AK	18.86	EV / J 60 AK	10.94	J 60 AKG	24.41	EV / J 60 AKG	10.94
8 - 5/16	J 80 AK	19.62	EV / J 80 AK	10.94	J 80 AKG	24.79	EV / J 80 AKG	10.94
10 - 3/8	J 100 AK	20.01	EV / J 100 AK	10.94	J 100 AKG	25.45	EV / J 100 AKG	10.94
11 - 7/16	J 110 AK	20.22	EV / J 110 AK	10.94	J 110 AKG	25.57	EV / J 110 AKG	10.94
12.5 - 1/2	J 125 AK	20.67	EV / J 125 AK	10.94	J 125 AKG	25.66	EV / J 125 AKG	10.94

Length = 2.5 m - 8' 2-1/2"	Brushed copper anodized aluminum (AKGB)				Satin brass anodized aluminum (AM)			
H = mm - in.	Profile	\$/ Length	Outside corner	\$/ Unit	Profile	\$/ Length	Outside corner	\$/ Unit
6 - 1/4	J 60 AKGB	21.91	EV / J 60 AKGB	10.94	J 60 AM	15.82	EV / J 60 AM	10.94
8 - 5/16	J 80 AKGB	22.60	EV / J 80 AKGB	10.94	J 80 AM	16.44	EV / J 80 AM	10.94
10 - 3/8	J 100 AKGB	23.07	EV / J 100 AKGB	10.94	J 100 AM	18.34	EV / J 100 AM	10.94
11 - 7/16	J 110 AKGB	23.30	EV / J 110 AKGB	10.94	J 110 AM	18.71	EV / J 110 AM	10.94
12.5 - 1/2	J 125 AKGB	23.62	EV / J 125 AKGB	10.94	J 125 AM	19.59	EV / J 125 AM	10.94



Schluter®-JOLLY								
Length = 2.5 m - 8' 2-1/2"	Polished brass anodized aluminum (AMG)				Brushed brass anodized aluminum (AMGB)			
H = mm - in.	Profile	\$ / Length	Outside corner	\$ / Unit	Profile	\$ / Length	Outside corner	\$ / Unit
6 - 1/4	J 60 AMG	18.54	EV / J 60 AMG	10.94	J 60 AMGB	21.08	EV / J 60 AMGB	10.94
8 - 5/16	J 80 AMG	19.82	EV / J 80 AMG	10.94	J 80 AMGB	21.81	EV / J 80 AMGB	10.94
10 - 3/8	J 100 AMG	22.35	EV / J 100 AMG	10.94	J 100 AMGB	23.40	EV / J 100 AMGB	10.94
11 - 7/16	J 110 AMG	22.80	EV / J 110 AMG	10.94	J 110 AMGB	23.87	EV / J 110 AMGB	10.94
12.5 - 1/2	J 125 AMG	23.64	EV / J 125 AMG	10.94	J 125 AMGB	24.64	EV / J 125 AMGB	10.94

Length = 2.5 m - 8' 2-1/2"	Brushed antique bronze anodized aluminum (ABGB)				Bright black anodized aluminum (AGSG)			
H = mm - in.	Profile	\$ / Length	Outside corner	\$ / Unit	Profile	\$ / Length	Outside corner	\$ / Unit
6 - 1/4	J 60 ABGB	23.41	EV / J 60 ABGB	10.94	J 60 AGSG	18.88	EV / J 60 AGSG	10.94
8 - 5/16	J 80 ABGB	24.62	EV / J 80 ABGB	10.94	J 80 AGSG	19.27	EV / J 80 AGSG	10.94
10 - 3/8	J 100 ABGB	25.37	EV / J 100 ABGB	10.94	J 100 AGSG	20.68	EV / J 100 AGSG	10.94
11 - 7/16	J 110 ABGB	26.13	EV / J 110 ABGB	10.94	J 110 AGSG	20.88	EV / J 110 AGSG	10.94
12.5 - 1/2	J 125 ABGB	27.48	EV / J 125 ABGB	10.94	J 125 AGSG	21.33	EV / J 125 AGSG	10.94

Length = 2.5 m - 8' 2-1/2"	Brushed graphite anodized aluminum (AGRB)			
H = mm - in.	Profile	\$ / Length	Outside corner	\$ / Unit
6 - 1/4	J 60 AGRB	23.41	EV / J 60 AGRB	10.94
8 - 5/16	J 80 AGRB	24.62	EV / J 80 AGRB	10.94
10 - 3/8	J 100 AGRB	25.86	EV / J 100 AGRB	10.94
11 - 7/16	J 110 AGRB	26.38	EV / J 110 AGRB	10.94
12.5 - 1/2	J 125 AGRB	27.48	EV / J 125 AGRB	10.94

10-foot (3.05 m) JOLLY Profiles – Anodized Aluminum								
Length = 3.05 m - 10'	Satin anodized aluminum (AE)		Polished chrome anodized aluminum (ACG)		Satin nickel anodized aluminum (AT)		Brushed antique bronze anodized aluminum (ABGB)	
H = mm - in.	Profile	\$ / Length	Profile	\$ / Length	Profile	\$ / Length	Profile	\$ / Length
8 - 5/16	J 80 AE / 300	19.71	J 80 ACG / 300	24.78	J 80 AT / 300	24.08	J 80 ABGB / 300	30.78
10 - 3/8	J 100 AE / 300	20.90	J 100 ACG / 300	27.40	J 100 AT / 300	24.54	J 100 ABGB / 300	31.72
12.5 - 1/2	J 125 AE / 300	22.41	J 125 ACG / 300	28.98	J 125 AT / 300	25.35	J 125 ABGB / 300	34.34

Special shipping conditions apply, see pages 207 - 208.

Connector	Quantity	\$ / Pkg.
V / J PP4	4	2.77



Note: The anchoring leg of Schluter®-JOLLY is available with a special radius perforation so that the profile can be used to form curves.

- Price surcharge: \$0.70 per foot
- Polished aluminum finishes require a relatively large bending radius
- Item No.: R / Profile No. (e.g., R/J 60 ACGB)
- For delivery time, please call Customer Service





Schluter®-TRENDLINE Textured Color-coated Aluminum

Schluter®-JOLLY					
Length = 2.5 m - 8' 2-1/2"		Textured color-coated aluminum (TS)			
H = mm - in.	Profile	\$/ Length	Outside corner	\$/ Unit	
6 - 1/4	J 60 + color*	33.37	EV / J 60 + color*	15.78	
8 - 5/16	J 80 + color*	34.12	EV / J 80 + color*	15.78	
10 - 3/8	J 100 + color*	34.78	EV / J 100 + color*	15.78	
11 - 7/16	J 110 + color*	35.14	EV / J 110 + color*	15.78	
12.5 - 1/2	J 125 + color*	35.83	EV / J 125 + color*	15.78	

***Color Codes**

* To complete the item number, add the **color** code (e.g., J 60 **TSC**).

Matte White and Matte Black

Length = 2.5 m - 8' 2-1/2"		Matte color-coated aluminum			
H = mm - in.	Profile	\$/ Length	Outside corner	\$/ Unit	
6 - 1/4	J 60 + color*	26.70	EV / J 60 + color*	14.22	
8 - 5/16	J 80 + color*	27.29	EV / J 80 + color*	14.22	
10 - 3/8	J 100 + color*	27.82	EV / J 100 + color*	14.22	
11 - 7/16	J 110 + color*	28.11	EV / J 110 + color*	14.22	
12.5 - 1/2	J 125 + color*	28.67	EV / J 125 + color*	14.22	

***Color Codes**

* To complete the item number, add the **color** code (e.g., J 60 **MGS**).

10-foot (3.05 m) JOLLY Profiles – Textured Color-coated Aluminum							
Length = 3.05 m - 10'		Textured color-coated aluminum (TS)		Matte white (MBW)		Matte black (MGS)	
H = mm - in.	Profile	\$/ Length	Profile	\$/ Length	Profile	\$/ Length	
6 - 1/4	J 60 + color* / 300	40.06	J 60 MBW / 300	32.05	J 60 MGS / 300	32.05	
8 - 5/16	J 80 + color* / 300	40.95	J 80 MBW / 300	32.74	J 80 MGS / 300	32.74	
10 - 3/8	J 100 + color* / 300	41.74	J 100 MBW / 300	33.38	J 100 MGS / 300	33.38	
11 - 7/16	J 110 + color* / 300	42.17	J 110 MBW / 300	33.74	J 110 MGS / 300	33.74	
12.5 - 1/2	J 125 + color* / 300	43.00	J 125 MBW / 300	34.40	J 125 MGS / 300	34.40	

Special shipping conditions apply, see pages 207 - 208.

Color-coated Aluminum

Length = 2.5 m - 8' 2-1/2"		Color-coated aluminum			
H = mm - in.	Profile	\$/ Length	Outside corner	\$/ Unit	
6 - 1/4	J 60 + color*	18.88	EV / J 60 + color*	10.16	
8 - 5/16	J 80 + color*	19.27	EV / J 80 + color*	10.16	
10 - 3/8	J 100 + color*	20.68	EV / J 100 + color*	10.16	
11 - 7/16	J 110 + color*	21.01	EV / J 110 + color*	10.16	
12.5 - 1/2	J 125 + color*	21.33	EV / J 125 + color*	10.16	

***Color Codes**

* To complete the item number, add the **color** code (e.g., J 60 **G**).

Connector	Quantity	\$/ Pkg.
V / J PP4	4	2.77



Note: The anchoring leg of Schluter®-JOLLY is available with a special radius perforation so that the profile can be used to form curves.

- Price surcharge: \$0.70 per foot
- Color-coated aluminum profiles require a relatively large bending radius
- Item No.: R / Profile No. (e.g., R/J 80 TSC)
- For delivery time, please call Customer Service





Schluter®-JOLLY-P

Schluter®-JOLLY-P is a PVC profile featuring an 87° angle designed to finish and protect external corners and other tile edges in wall applications. The vertical wall section of the profile provides a decorative finish and protects adjacent tiles. JOLLY-P in sizes 1/4" (6 mm) and higher features an integrated joint spacer that establishes a defined joint cavity between the tile and the profile.

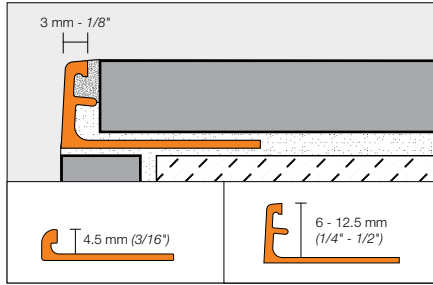

Schluter®-JOLLY-P		
Length = 2.5 m - 8' 2-1/2"	PVC	
H = mm - in.	Item No.	\$ / Length
4.5 - 3/16	color* + 45	6.14
6 - 1/4	color* + 60	6.24
8 - 5/16	color* + 80	6.52
10 - 3/8	color* + 100	6.66
11 - 7/16	color* + 110	6.85
12.5 - 1/2	color* + 125	7.03

10-foot (3.05 m) JOLLY-P Profiles – PVC		
Length = 3.05 m - 10'	Bright white (BW)	
H = mm - in.	Item No.	\$ / Length
8 - 5/16	BW 80 / 300	8.13
10 - 3/8	BW 100 / 300	8.33
12.5 - 1/2	BW 125 / 300	8.78

Special shipping conditions apply, see pages 207 - 208.

***Color Codes**

BW	W	SP	BH	HB	HG	PG	G	GS
Bright white	White	Sand pebble	Bahama	Light beige	Light grey	Classic grey	Grey	Black

* To complete the item number, add the color code (e.g., G 45).

Get perfect cuts!
Schluter®-SNIPS for PVC profiles.
See page 197 for more information.



Schluter®-SCHIENE

Schluter®-SCHIENE is an edging profile featuring an 87° angle designed to finish and protect external corners and other tile edges. Though SCHIENE is typically used in floor applications, the finishes listed in this section are specifically suited for use in wall applications. SCHIENE in sizes 1/4" (6 mm) and higher features an integrated joint spacer that establishes a defined joint cavity between the tile and the profile.

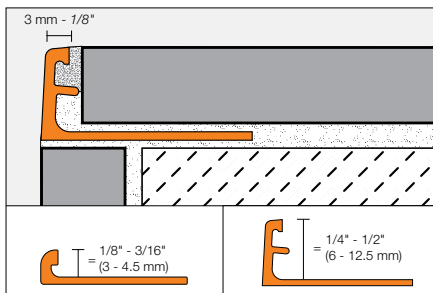

Notes:

- Also available in chrome-plated brass. Contact Customer Service for pricing and availability.
- RADIUS available, see page 17 for details.

Please be advised that SCHIENE in Bright Black and Brushed Graphite Anodized Aluminum (AGSG and AGRB), Chrome-plated Brass (MC), and in all colors of Color-coated Aluminum are being discontinued. These items will only remain available while supplies last.

Please reference JOLLY as an alternative option to these discontinued SCHIENE finishes.

Schluter®-SCHIENE						
Length = 2.5 m - 8' 2-1/2"	Bright black anodized aluminum (AGSG)		Brushed graphite anodized aluminum (AGRB)		Color-coated aluminum	
H = mm - in.	Item No.	\$ / Length	Item No.	\$ / Length	Item No.	\$ / Length
3 - 1/8	-	-	-	-	A 30 + color*	16.90
4.5 - 3/16	A 45 AGSG	17.52	-	-	A 45 + color*	17.52
6 - 1/4	A 60 AGSG	18.51	A 60 AGRB	22.95	A 60 + color*	18.51
8 - 5/16	A 80 AGSG	18.89	A 80 AGRB	24.14	A 80 + color*	18.89
10 - 3/8	A 100 AGSG	20.27	A 100 AGRB	25.35	A 100 + color*	20.27
11 - 7/16	-	-	-	-	A 110 + color*	20.60
12.5 - 1/2	A 125 AGSG	20.91	A 125 AGRB	26.94	A 125 + color*	20.91

***Color Codes**

BW	W	SP	BH	HB	HG
Bright white	White	Sand pebble	Bahama	Light beige	Light grey
PG	G	GM	RB ¹	SB	GS
Classic grey	Grey	Metallic grey	Red brown	Black brown	Black

¹ Red brown (RB) is only available in sizes 80, 100, and 125.

* To complete the item number, add the color code (e.g., A 45 G).



Schluter®-RONDEC

Schluter®-RONDEC is a finishing and edge-protection profile for tiled edges and outside corners of tiled surfaces. The reveal of the profile forms a symmetrically rounded corner along the surface edge. RONDEC allows for color coordination with tile and grout and the creation of interesting accents in decorative designs. The profile can be combined with the Schluter®-DESIGNLINE border profile for further design options. RONDEC in aluminum and PVC features an integrated joint spacer that establishes a defined joint cavity between the tile and the profile.

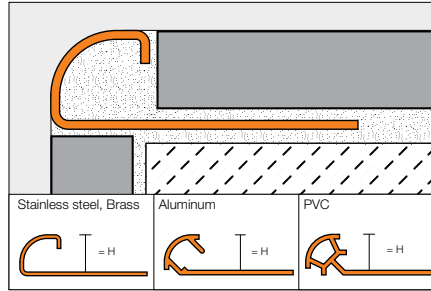

Accessories

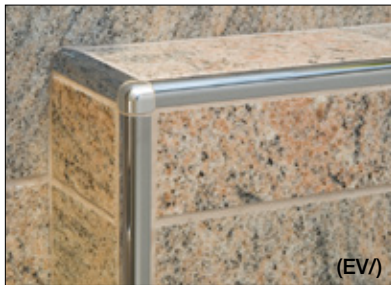

90° Outside corner



90° Inside corner

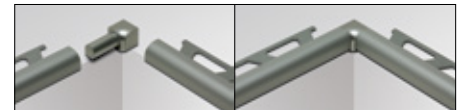

RONDEC prefabricated corners eliminate the need for a mitered edge.



Corners with item numbers beginning with EV/ are milled out of solid aluminum and corners with item numbers beginning with ED/ are die cast metal.



90° Double-leg outside corner (E2L/)



90° Double-leg inside corner (I2L/)

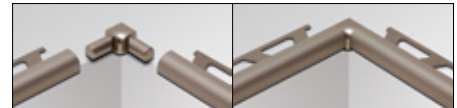

Double-leg corners simplify the framing of smaller elements with the RONDEC profile, such as niches, windows, etc. The legs are detachable for use in applications where a single-leg corner is needed.



Sink corner with 3/8" (10 mm) radius (I2S/)

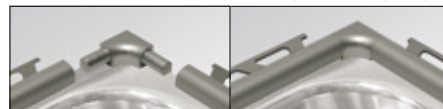

Sink corner with 1-1/2" (38 mm) radius (ISK/)



Stainless steel sink corners are used with the RONDEC profile to produce tiled-under sinks. The corners have a large radius (3/8" - 10 mm or 1-1/2" - 38 mm) that allows them to match up to the contour of the most standard sinks. The 3/8" corner piece features a double-leg design for ease of installation, while the 1-1/2" corner includes two stainless steel connectors to maintain the alignment of the corner piece and profiles during installation.

Connector Stainless Steel (V/)



Connector PVC (V/)

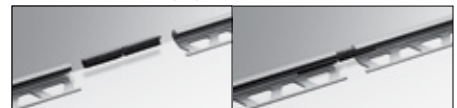

RONDEC connectors simplify the alignment of adjacent profile sections. Connectors are made of either PVC for aluminum profiles or stainless steel for stainless steel profiles.



End cap



End caps feature a bendable leg that is inserted into the RONDEC profile, and a brushed stainless steel plate that covers the open area of the profile in applications where the end of the profile is to be left exposed. RONDEC end caps can be used with stainless steel and brushed stainless steel RONDEC profiles.



Stainless Steel 304 (1.4301 = V2A)



Note: RONDEC in sizes 60, 80, 100, and 125 is also available in stainless steel 316L (1.4404 = V4A). Contact customer service for price and availability.

Schluter®-RONDEC								
Length = 2.5 m - 8' 2-1/2"								
Stainless steel 304 (1.4301 = V2A) (E)								
H = mm - in.	Profile	\$/ Length	Outside corner, 90°	\$/ Unit	Sink corner 3/8" (10 mm) radius	\$/ Unit	Sink corner 1-1/2" (38 mm) radius	\$/ Unit
4.5 - 3/16	RO 45 E	47.31	EV/RO 45 E	34.97	-	-	-	-
6 - 1/4	RO 60 E	49.24	EV/RO 60 E	34.97	-	-	-	-
7 - 9/32	RO 70 E	51.06	EV/RO 70 E	37.56	-	-	-	-
8 - 5/16	RO 80 E	51.41	EV/RO 80 E	37.56	I2S/RO 80 E/V2A	56.39	ISK/RO 80 E/38	29.36
9 - 11/32	RO 90 E	54.90	EV/RO 90 E	40.34	-	-	-	-
10 - 3/8	RO 100 E	55.20	EV/RO 100 E	40.34	I2S/RO 100 E/V2A	56.39	ISK/RO 100 E/38	29.36
11 - 7/16	RO 110 E	57.00	EV/RO 110 E	41.75	-	-	-	-
12.5 - 1/2	RO 125 E	58.80	EV/RO 125 E	41.75	I2S/RO 125 E/V2A	56.39	ISK/RO 125 E/38	29.36
15 - 9/16	RO 150 E	66.61	EV/RO 150 E	42.72	-	-	-	-

Length = 2.5 m - 8' 2-1/2"					
Brushed stainless steel 304 (1.4301 = V2A) (EB)			Die cast metal with stainless steel appearance		
H = mm - in.	End cap	\$/ Unit	Outside corner, 90°	Inside corner, 90°	\$/ Unit
6 - 1/4	-	-	ED/RO 60 E	ID/RO 60 E	8.27
8 - 5/16	EK/RO 80 EB	5.02	ED/RO 80 E	ID/RO 80 E	8.27
10 - 3/8	EK/RO 100 EB	5.02	ED/RO 100 E	ID/RO 100 E	8.27
12.5 - 1/2	EK/RO 125 EB	5.02	ED/RO 125 E	ID/RO 125 E	8.27

Length = 2.5 m - 8' 2-1/2"								
Brushed stainless steel 304 (1.4301 = V2A) (EB)								
H = mm - in.	Profile	\$/ Length	Outside corner, 90°	\$/ Unit	Sink corner 3/8" (10 mm) radius	\$/ Unit	End cap	\$/ Unit
6 - 1/4	RO 60 EB	75.52	EV/RO 60 EB	42.42	-	-	-	-
7 - 9/32	RO 70 EB	77.00	EV/RO 70 EB	42.42	-	-	-	-
8 - 5/16	RO 80 EB	78.82	EV/RO 80 EB	42.42	I2S/RO 80 EB/V2A	56.39	EK/RO 80 EB	5.02
9 - 11/32	RO 90 EB	80.40	EV/RO 90 EB	42.42	-	-	-	-
10 - 3/8	RO 100 EB	82.32	EV/RO 100 EB	48.95	I2S/RO 100 EB/V2A	56.39	EK/RO 100 EB	5.02
11 - 7/16	RO 110 EB	83.96	EV/RO 110 EB	48.95	-	-	-	-
12.5 - 1/2	RO 125 EB	85.91	EV/RO 125 EB	48.95	I2S/RO 125 EB/V2A	56.39	EK/RO 125 EB	5.02
15 - 9/16	RO 150 EB	94.53	EV/RO 150 EB	51.87	-	-	-	-

Stainless steel 304 (1.4301 = V2A) (E)		
H = mm - in.	Connector	\$/ Unit
6 - 1/4	V/RO 60 E	6.58
8 - 5/16	V/RO 80 E	6.58
10 - 3/8	V/RO 100 E	6.58
11 - 7/16	V/RO 110 E	6.58
12.5 - 1/2	V/RO 125 E	6.58



Brass



Schluter®-RONDEC						
Length = 2.5 m - 8' 2-1/2"		Chrome-plated solid brass (MC)*		Aluminum with polished chrome finish		
H = mm - in.	Profile	\$ / Length	Outside corner, 90°	Inside corner, 90°	\$ / Unit	
6 - 1/4	RO 60 MC	129.46	EV/RO 60 ACG	IV/RO 60 ACG	9.80	
8 - 5/16	RO 80 MC	136.88	EV/RO 80 ACG	IV/RO 80 ACG	9.80	
10 - 3/8	RO 100 MC	142.77	EV/RO 100 ACG	IV/RO 100 ACG	9.80	
12.5 - 1/2	RO 125 MC	150.40	EV/RO 125 ACG	IV/RO 125 ACG	9.80	

Anodized Aluminum



Schluter®-RONDEC						
Length = 2.5 m - 8' 2-1/2"		Satin anodized aluminum (AE)				
H = mm - in.	Profile	\$ / Length	Outside corner, 90°	Inside corner, 90°	\$ / Unit	Connector
6 - 1/4	RO 60 AE	18.73	EV/RO 60 AE	IV/RO 60 AE	8.27	V/RO 60
8 - 5/16	RO 80 AE	19.54	EV/RO 80 AE	IV/RO 80 AE	8.27	V/RO 80
10 - 3/8	RO 100 AE	21.10	EV/RO 100 AE	IV/RO 100 AE	8.27	V/RO 100
12.5 - 1/2	RO 125 AE	23.57	EV/RO 125 AE	IV/RO 125 AE	8.27	V/RO 125

H = mm - in.	Double-leg outside corner, 90°	Double-leg inside corner, 90°	\$ / Unit
8 - 5/16	E2L/RO 80 AE	I2L/RO 80 AE	17.74
10 - 3/8	E2L/RO 100 AE	I2L/RO 100 AE	17.74
12.5 - 1/2	E2L/RO 125 AE	I2L/RO 125 AE	17.74

Length = 2.5 m - 8' 2-1/2"		Polished chrome anod. alu. (ACG)				
H = mm - in.	Profile	\$ / Length	Outside corner, 90°	Inside corner, 90°	\$ / Unit	Connector
6 - 1/4	RO 60 ACG	22.90	EV/RO 60 ACG	IV/RO 60 ACG	9.80	V/RO 60
8 - 5/16	RO 80 ACG	25.66	EV/RO 80 ACG	IV/RO 80 ACG	9.80	V/RO 80
10 - 3/8	RO 100 ACG	28.43	EV/RO 100 ACG	IV/RO 100 ACG	9.80	V/RO 100
12.5 - 1/2	RO 125 ACG	33.27	EV/RO 125 ACG	IV/RO 125 ACG	9.80	V/RO 125

H = mm - in.	Double-leg outside corner, 90°	Double-leg inside corner, 90°	\$ / Unit
8 - 5/16	E2L/RO 80 ACG	I2L/RO 80 ACG	17.06
10 - 3/8	E2L/RO 100 ACG	I2L/RO 100 ACG	17.06
12.5 - 1/2	E2L/RO 125 ACG	I2L/RO 125 ACG	17.06

Length = 2.5 m - 8' 2-1/2"		Brushed chrome anod. alu. (ACGB)				
H = mm - in.	Profile	\$ / Length	Outside corner, 90°	Inside corner, 90°	\$ / Unit	Connector
6 - 1/4	RO 60 ACGB	23.57	EV/RO 60 ACGB	IV/RO 60 ACGB	15.44	V/RO 60
8 - 5/16	RO 80 ACGB	26.35	EV/RO 80 ACGB	IV/RO 80 ACGB	15.44	V/RO 80
10 - 3/8	RO 100 ACGB	29.80	EV/RO 100 ACGB	IV/RO 100 ACGB	15.44	V/RO 100
12.5 - 1/2	RO 125 ACGB	34.67	EV/RO 125 ACGB	IV/RO 125 ACGB	15.44	V/RO 125

H = mm - in.	Double-leg outside corner, 90°	Double-leg inside corner, 90°	\$ / Unit
8 - 5/16	E2L/RO 80 ACGB	I2L/RO 80 ACGB	21.04
10 - 3/8	E2L/RO 100 ACGB	I2L/RO 100 ACGB	21.04
12.5 - 1/2	E2L/RO 125 ACGB	I2L/RO 125 ACGB	21.04



Schluter®-RONDEC							
Length = 2.5 m - 8' 2-1/2"	Satin nickel anod. alu. (AT)						
H = mm - in.	Profile	\$/ Length	Outside corner, 90°	Inside corner, 90°	\$/ Unit	Connector	\$/ Unit
6 - 1/4	RO 60 AT	19.17	EV/RO 60 AT	IV/RO 60 AT	8.34	V/RO 60	2.75
8 - 5/16	RO 80 AT	20.47	EV/RO 80 AT	IV/RO 80 AT	8.34	V/RO 80	2.75
10 - 3/8	RO 100 AT	21.39	EV/RO 100 AT	IV/RO 100 AT	8.34	V/RO 100	2.75
12.5 - 1/2	RO 125 AT	24.27	EV/RO 125 AT	IV/RO 125 AT	8.34	V/RO 125	2.75

H = mm - in.	Double-leg outside corner, 90°	Double-leg inside corner, 90°	\$/ Unit
8 - 5/16	E2L/RO 80 AT	I2L/RO 80 AT	17.50
10 - 3/8	E2L/RO 100 AT	I2L/RO 100 AT	17.50
12.5 - 1/2	E2L/RO 125 AT	I2L/RO 125 AT	17.50

Length = 2.5 m - 8' 2-1/2"	Polished nickel anod. alu. (ATG)						
H = mm - in.	Profile	\$/ Length	Outside corner, 90°	Inside corner, 90°	\$/ Unit	Connector	\$/ Unit
6 - 1/4	RO 60 ATG	24.99	EV/RO 60 ATG	IV/RO 60 ATG	9.80	V/RO 60	2.75
8 - 5/16	RO 80 ATG	26.35	EV/RO 80 ATG	IV/RO 80 ATG	9.80	V/RO 80	2.75
10 - 3/8	RO 100 ATG	31.21	EV/RO 100 ATG	IV/RO 100 ATG	9.80	V/RO 100	2.75
12.5 - 1/2	RO 125 ATG	35.36	EV/RO 125 ATG	IV/RO 125 ATG	9.80	V/RO 125	2.75

H = mm - in.	Double-leg outside corner, 90°	Double-leg inside corner, 90°	\$/ Unit
8 - 5/16	E2L/RO 80 ATG	I2L/RO 80 ATG	17.74
10 - 3/8	E2L/RO 100 ATG	I2L/RO 100 ATG	17.74
12.5 - 1/2	E2L/RO 125 ATG	I2L/RO 125 ATG	17.74

Length = 2.5 m - 8' 2-1/2"	Brushed nickel anod. alu. (ATGB)						
H = mm - in.	Profile	\$/ Length	Outside corner, 90°	Inside corner, 90°	\$/ Unit	Connector	\$/ Unit
6 - 1/4	RO 60 ATGB	26.35	EV/RO 60 ATGB	IV/RO 60 ATGB	15.28	V/RO 60	2.75
8 - 5/16	RO 80 ATGB	29.12	EV/RO 80 ATGB	IV/RO 80 ATGB	15.28	V/RO 80	2.75
10 - 3/8	RO 100 ATGB	31.98	EV/RO 100 ATGB	IV/RO 100 ATGB	15.28	V/RO 100	2.75
12.5 - 1/2	RO 125 ATGB	37.09	EV/RO 125 ATGB	IV/RO 125 ATGB	15.28	V/RO 125	2.75

H = mm - in.	Double-leg outside corner, 90°	Double-leg inside corner, 90°	\$/ Unit
8 - 5/16	E2L/RO 80 ATGB	I2L/RO 80 ATGB	21.87
10 - 3/8	E2L/RO 100 ATGB	I2L/RO 100 ATGB	21.87
12.5 - 1/2	E2L/RO 125 ATGB	I2L/RO 125 ATGB	21.87

Length = 2.5 m - 8' 2-1/2"	Satin copper anod. alu. (AK)						
H = mm - in.	Profile	\$/ Length	Outside corner, 90°	Inside corner, 90°	\$/ Unit	Connector	\$/ Unit
6 - 1/4	RO 60 AK	20.11	EV/RO 60 AK	IV/RO 60 AK	8.27	V/RO 60	2.75
8 - 5/16	RO 80 AK	21.49	EV/RO 80 AK	IV/RO 80 AK	8.27	V/RO 80	2.75
10 - 3/8	RO 100 AK	22.87	EV/RO 100 AK	IV/RO 100 AK	8.27	V/RO 100	2.75
12.5 - 1/2	RO 125 AK	24.27	EV/RO 125 AK	IV/RO 125 AK	8.27	V/RO 125	2.75

H = mm - in.	Double-leg outside corner, 90°	Double-leg inside corner, 90°	\$/ Unit
8 - 5/16	E2L/RO 80 AK	I2L/RO 80 AK	17.22
10 - 3/8	E2L/RO 100 AK	I2L/RO 100 AK	17.22
12.5 - 1/2	E2L/RO 125 AK	I2L/RO 125 AK	17.22



Schluter®-RONDEC							
Length = 2.5 m - 8' 2-1/2"	Polished copper anod. alu. (AKG)						
H = mm - in.	Profile	\$/ Length	Outside corner, 90°	Inside corner, 90°	\$/ Unit	Connector	\$/ Unit
6 - 1/4	RO 60 AKG	24.99	EV/RO 60 AKG	IV/RO 60 AKG	9.80	V/RO 60	2.75
8 - 5/16	RO 80 AKG	26.35	EV/RO 80 AKG	IV/RO 80 AKG	9.80	V/RO 80	2.75
10 - 3/8	RO 100 AKG	31.21	EV/RO 100 AKG	IV/RO 100 AKG	9.80	V/RO 100	2.75
12.5 - 1/2	RO 125 AKG	35.36	EV/RO 125 AKG	IV/RO 125 AKG	9.80	V/RO 125	2.75

H = mm - in.	Double-leg outside corner, 90°	Double-leg inside corner, 90°	\$/ Unit
8 - 5/16	E2L/RO 80 AKG	I2L/RO 80 AKG	17.56
10 - 3/8	E2L/RO 100 AKG	I2L/RO 100 AKG	17.56
12.5 - 1/2	E2L/RO 125 AKG	I2L/RO 125 AKG	17.56

Length = 2.5 m - 8' 2-1/2"	Brushed copper anod. alu. (AKGB)						
H = mm - in.	Profile	\$/ Length	Outside corner, 90°	Inside corner, 90°	\$/ Unit	Connector	\$/ Unit
6 - 1/4	RO 60 AKGB	26.35	EV/RO 60 AKGB	IV/RO 60 AKGB	15.44	V/RO 60	2.75
8 - 5/16	RO 80 AKGB	29.12	EV/RO 80 AKGB	IV/RO 80 AKGB	15.44	V/RO 80	2.75
10 - 3/8	RO 100 AKGB	32.59	EV/RO 100 AKGB	IV/RO 100 AKGB	15.44	V/RO 100	2.75
12.5 - 1/2	RO 125 AKGB	37.09	EV/RO 125 AKGB	IV/RO 125 AKGB	15.44	V/RO 125	2.75

H = mm - in.	Double-leg outside corner, 90°	Double-leg inside corner, 90°	\$/ Unit
8 - 5/16	E2L/RO 80 AKGB	I2L/RO 80 AKGB	21.44
10 - 3/8	E2L/RO 100 AKGB	I2L/RO 100 AKGB	21.44
12.5 - 1/2	E2L/RO 125 AKGB	I2L/RO 125 AKGB	21.44

Length = 2.5 m - 8' 2-1/2"	Brushed antique bronze anod. alu. (ABGB)						
H = mm - in.	Profile	\$/ Length	Outside corner, 90°	Inside corner, 90°	\$/ Unit	Connector	\$/ Unit
6 - 1/4	RO 60 ABGB	26.35	EV/RO 60 ABGB	IV/RO 60 ABGB	15.44	V/RO 60	2.75
8 - 5/16	RO 80 ABGB	29.12	EV/RO 80 ABGB	IV/RO 80 ABGB	15.44	V/RO 80	2.75
10 - 3/8	RO 100 ABGB	32.59	EV/RO 100 ABGB	IV/RO 100 ABGB	15.44	V/RO 100	2.75
12.5 - 1/2	RO 125 ABGB	37.09	EV/RO 125 ABGB	IV/RO 125 ABGB	15.44	V/RO 125	2.75

H = mm - in.	Double-leg outside corner, 90°	Double-leg inside corner, 90°	\$/ Unit
8 - 5/16	E2L/RO 80 ABGB	I2L/RO 80 ABGB	21.44
10 - 3/8	E2L/RO 100 ABGB	I2L/RO 100 ABGB	21.44
12.5 - 1/2	E2L/RO 125 ABGB	I2L/RO 125 ABGB	21.44

Length = 2.5 m - 8' 2-1/2"	Satin brass anod. alu. (AM)						
H = mm - in.	Profile	\$/ Length	Outside corner, 90°	Inside corner, 90°	\$/ Unit	Connector	\$/ Unit
6 - 1/4	RO 60 AM	20.11	EV/RO 60 AM	IV/RO 60 AM	8.34	V/RO 60	2.75
8 - 5/16	RO 80 AM	22.90	EV/RO 80 AM	IV/RO 80 AM	8.34	V/RO 80	2.75
10 - 3/8	RO 100 AM	25.66	EV/RO 100 AM	IV/RO 100 AM	8.34	V/RO 100	2.75
12.5 - 1/2	RO 125 AM	29.80	EV/RO 125 AM	IV/RO 125 AM	8.34	V/RO 125	2.75

H = mm - in.	Double-leg outside corner, 90°	Double-leg inside corner, 90°	\$/ Unit
8 - 5/16	E2L/RO 80 AM	I2L/RO 80 AM	17.22
10 - 3/8	E2L/RO 100 AM	I2L/RO 100 AM	17.22
12.5 - 1/2	E2L/RO 125 AM	I2L/RO 125 AM	17.22



Schluter®-RONDEC							
Length = 2.5 m - 8' 2-1/2"		Polished brass anod. alu. (AMG)					
H = mm - in.	Profile	\$ / Length	Outside corner, 90°	Inside corner, 90°	\$ / Unit	Connector	\$ / Unit
6 - 1/4	RO 60 AMG	23.57	EV/RO 60 AMG	IV/RO 60 AMG	9.80	V/RO 60	2.75
8 - 5/16	RO 80 AMG	26.35	EV/RO 80 AMG	IV/RO 80 AMG	9.80	V/RO 80	2.75
10 - 3/8	RO 100 AMG	29.80	EV/RO 100 AMG	IV/RO 100 AMG	9.80	V/RO 100	2.75
12.5 - 1/2	RO 125 AMG	33.98	EV/RO 125 AMG	IV/RO 125 AMG	9.80	V/RO 125	2.75

H = mm - in.	Double-leg outside corner, 90°	Double-leg inside corner, 90°	\$ / Unit
8 - 5/16	E2L/RO 80 AMG	I2L/RO 80 AMG	17.22
10 - 3/8	E2L/RO 100 AMG	I2L/RO 100 AMG	17.22
12.5 - 1/2	E2L/RO 125 AMG	I2L/RO 125 AMG	17.22

Length = 2.5 m - 8' 2-1/2"		Brushed brass anod. alu. (AMGB)					
H = mm - in.	Profile	\$ / Length	Outside corner, 90°	Inside corner, 90°	\$ / Unit	Connector	\$ / Unit
6 - 1/4	RO 60 AMGB	24.96	EV/RO 60 AMGB	IV/RO 60 AMGB	15.73	V/RO 60	2.75
8 - 5/16	RO 80 AMGB	27.70	EV/RO 80 AMGB	IV/RO 80 AMGB	15.73	V/RO 80	2.75
10 - 3/8	RO 100 AMGB	31.21	EV/RO 100 AMGB	IV/RO 100 AMGB	15.73	V/RO 100	2.75
12.5 - 1/2	RO 125 AMGB	35.36	EV/RO 125 AMGB	IV/RO 125 AMGB	15.73	V/RO 125	2.75

H = mm - in.	Double-leg outside corner, 90°	Double-leg inside corner, 90°	\$ / Unit
8 - 5/16	E2L/RO 80 AMGB	I2L/RO 80 AMGB	21.87
10 - 3/8	E2L/RO 100 AMGB	I2L/RO 100 AMGB	21.87
12.5 - 1/2	E2L/RO 125 AMGB	I2L/RO 125 AMGB	21.87

Length = 2.5 m - 8' 2-1/2"		Graphite anod. alu. (AGR)					
H = mm - in.	Profile	\$ / Length	Outside corner, 90°	Inside corner, 90°	\$ / Unit	Connector	\$ / Unit
6 - 1/4	RO 60 AGR	20.52	EV/RO 60 AGR	IV/RO 60 AGR	8.44	V/RO 60	2.75
8 - 5/16	RO 80 AGR	21.93	EV/RO 80 AGR	IV/RO 80 AGR	8.44	V/RO 80	2.75
10 - 3/8	RO 100 AGR	23.35	EV/RO 100 AGR	IV/RO 100 AGR	8.44	V/RO 100	2.75
12.5 - 1/2	RO 125 AGR	24.75	EV/RO 125 AGR	IV/RO 125 AGR	8.44	V/RO 125	2.75

H = mm - in.	Double-leg outside corner, 90°	Double-leg inside corner, 90°	\$ / Unit
8 - 5/16	E2L/RO 80 AGR	I2L/RO 80 AGR	17.56
10 - 3/8	E2L/RO 100 AGR	I2L/RO 100 AGR	17.56
12.5 - 1/2	E2L/RO 125 AGR	I2L/RO 125 AGR	17.56

Length = 2.5 m - 8' 2-1/2"		Bright black anod. alu. (AGSG)					
H = mm - in.	Profile	\$ / Length	Outside corner, 90°	Inside corner, 90°	\$ / Unit	Connector	\$ / Unit
6 - 1/4	RO 60 AGSG	25.47	EV/RO 60 AGSG	IV/RO 60 AGSG	10.30	V/RO 60	2.75
8 - 5/16	RO 80 AGSG	26.86	EV/RO 80 AGSG	IV/RO 80 AGSG	10.30	V/RO 80	2.75
10 - 3/8	RO 100 AGSG	31.81	EV/RO 100 AGSG	IV/RO 100 AGSG	10.30	V/RO 100	2.75
12.5 - 1/2	RO 125 AGSG	36.07	EV/RO 125 AGSG	IV/RO 125 AGSG	10.30	V/RO 125	2.75

H = mm - in.	Double-leg outside corner, 90°	Double-leg inside corner, 90°	\$ / Unit
8 - 5/16	E2L/RO 80 AGSG	I2L/RO 80 AGSG	17.91
10 - 3/8	E2L/RO 100 AGSG	I2L/RO 100 AGSG	17.91
12.5 - 1/2	E2L/RO 125 AGSG	I2L/RO 125 AGSG	17.91



Schluter®-RONDEC

Length = 2.5 m - 8' 2-1/2"	Brushed black anod. alu. (AGSB)						
H = mm - in.	Profile	\$ / Length	Outside corner, 90°	Inside corner, 90°	\$ / Unit	Connector	\$ / Unit
6 - 1/4	RO 60 AGSB	26.35	EV/RO 60 AGSB	IV/RO 60 AGSB	15.58	V/RO 60	2.75
8 - 5/16	RO 80 AGSB	29.12	EV/RO 80 AGSB	IV/RO 80 AGSB	15.58	V/RO 80	2.75
10 - 3/8	RO 100 AGSB	32.59	EV/RO 100 AGSB	IV/RO 100 AGSB	15.58	V/RO 100	2.75
12.5 - 1/2	RO 125 AGSB	36.04	EV/RO 125 AGSB	IV/RO 125 AGSB	15.58	V/RO 125	2.75

H = mm - in.	Double-leg outside corner, 90°	Double-leg inside corner, 90°	\$ / Unit
8 - 5/16	E2L/RO 80 AGSB	I2L/RO 80 AGSB	21.44
10 - 3/8	E2L/RO 100 AGSB	I2L/RO 100 AGSB	21.44
12.5 - 1/2	E2L/RO 125 AGSB	I2L/RO 125 AGSB	21.44

10-foot (3.05 m) RONDEC Profiles – Anodized Aluminum

Length = 3.05 m - 10'	Satin anod. alu. (AE)		Polished chrome anod. alu. (ACG)		Satin nickel anod. alu. (AT)	
H = mm - in.	Profile	\$ / Length	Profile	\$ / Length	Profile	\$ / Length
8 - 5/16	RO 80 AE / 300	24.41	RO 80 ACG / 300	32.09	RO 80 AT / 300	25.57
10 - 3/8	RO 100 AE / 300	26.39	RO 100 ACG / 300	35.54	RO 100 AT / 300	26.74
12.5 - 1/2	RO 125 AE / 300	29.45	RO 125 ACG / 300	41.59	RO 125 AT / 300	30.35

Special shipping conditions apply, see pages 207 - 208.



RONDEC in brushed chrome (page 32)



Schluter®-TRENDLINE Textured Color-coated Aluminum



Schluter®-RONDEC							
Length = 2.5 m - 8' 2-1/2"		Textured color-coated aluminum (TS)					
H = mm - in.	Profile	\$ / Length	Outside corner, 90°	Inside corner, 90°	\$ / Unit	Connector	\$ / Unit
6 - 1/4	RO 60 + color*	43.34	EV/RO 60 + color*	IV/RO 60 + color*	15.45	V/RO 60	2.75
8 - 5/16	RO 80 + color*	44.23	EV/RO 80 + color*	IV/RO 80 + color*	15.45	V/RO 80	2.75
10 - 3/8	RO 100 + color*	45.66	EV/RO 100 + color*	IV/RO 100 + color*	15.45	V/RO 100	2.75
11 - 7/16	RO 110 + color*	46.17	EV/RO 110 + color*	IV/RO 110 + color*	15.45	V/RO 110	2.75
12.5 - 1/2	RO 125 + color*	46.63	EV/RO 125 + color*	IV/RO 125 + color*	15.45	V/RO 125	2.75

***Color Codes**

Ivory	Greige	Stone grey	Cream	Beige	Rustic brown	Bronze	Pewter	Light anthracite	Dark anthracite

* To complete the item number, add the color code (e.g., RO 60 TSC).

Matte White and Matte Black

Length = 2.5 m - 8' 2-1/2"		Matte color-coated aluminum					
H = mm - in.	Profile	\$ / Length	Outside corner, 90° (die cast)	Inside corner, 90° (die cast)	\$ / Unit	Connector	\$ / Unit
6 - 1/4	RO 60 + color*	34.67	ED/RO 60 + color*	ID/RO 60 + color*	12.00	V/RO 60	2.75
8 - 5/16	RO 80 + color*	35.38	ED/RO 80 + color*	ID/RO 80 + color*	12.00	V/RO 80	2.75
10 - 3/8	RO 100 + color*	36.53	ED/RO 100 + color*	ID/RO 100 + color*	12.00	V/RO 100	2.75
11 - 7/16	RO 110 + color*	36.94	ED/RO 110 + color*	ID/RO 110 + color*	12.00	V/RO 110	2.75
12.5 - 1/2	RO 125 + color*	37.30	ED/RO 125 + color*	ID/RO 125 + color*	12.00	V/RO 125	2.75

***Color Codes**

		* To complete the item number, add the color code (e.g., RO 60 MGS).
Matte white	Matte black	

10-foot (3.05 m) RONDEC Profiles – Textured Color-coated Aluminum							
Length = 3.05 m - 10'		Textured color-coated aluminum (TS)		Matte white (MBW)		Matte black (MGS)	
H = mm - in.	Profile	\$ / Length	Profile	\$ / Length	Profile	\$ / Length	
6 - 1/4	RO 60 + color* / 300	54.17	RO 60 MBW / 300	43.34	RO 60 MGS / 300	43.34	
8 - 5/16	RO 80 + color* / 300	55.28	RO 80 MBW / 300	44.23	RO 80 MGS / 300	44.23	
10 - 3/8	RO 100 + color* / 300	57.09	RO 100 MBW / 300	45.66	RO 100 MGS / 300	45.66	
11 - 7/16	RO 110 + color* / 300	57.70	RO 110 MBW / 300	46.18	RO 110 MGS / 300	46.18	
12.5 - 1/2	RO 125 + color* / 300	58.30	RO 125 MBW / 300	46.63	RO 125 MGS / 300	46.63	

Special shipping conditions apply, see pages 207 - 208.



Color-coated Aluminum



Schluter®-RONDEC							
Length = 2.5 m - 8' 2-1/2"		Color-coated aluminum (AC)					
H = mm - in.	Profile	\$ / Length	Outside corner, 90° (die cast)	Inside corner, 90° (die cast)	\$ / Unit	Connector	\$ / Unit
6 - 1/4	RO 60 + color*	22.03	ED/RO 60 + color*	ID/RO 60 + color*	4.97	V/RO 60	2.75
8 - 5/16	RO 80 + color*	24.68	ED/RO 80 + color*	ID/RO 80 + color*	4.97	V/RO 80	2.75
10 - 3/8	RO 100 + color*	27.07	ED/RO 100 + color*	ID/RO 100 + color*	4.97	V/RO 100	2.75
12.5 - 1/2	RO 125 + color*	33.83	ED/RO 125 + color*	ID/RO 125 + color*	4.97	V/RO 125	2.75

***Color Codes**

Bright white	White	Sand pebble	Bahama	Light beige	Light grey	Classic grey	Grey	Metallic grey	Black brown	Black

* To complete the item number, add the color code (e.g., RO 60 G).

PVC



Length = 2.5 m - 8' 2-1/2"		PVC (P)				
H = mm - in.	Profile	\$ / Length	Outside corner, 90°	Inside corner, 90°	\$ / Unit	
6 - 1/4	PRO 60 + color*	7.64	E/PRO 60 + color*	I/PRO 60 + color*	3.02	
8 - 5/16	PRO 80 + color*	8.05	E/PRO 80 + color*	I/PRO 80 + color*	3.02	
10 - 3/8	PRO 100 + color*	8.58	E/PRO 100 + color*	I/PRO 100 + color*	3.02	
11 - 7/16	PRO 110 + color*	9.64	E/PRO 110 + color*	I/PRO 110 + color*	3.02	
12.5 - 1/2	PRO 125 + color*	10.73	E/PRO 125 + color*	I/PRO 125 + color*	3.02	

***Color Codes**

Bright white	White	Sand pebble	Bahama	Light beige	Light grey	Classic grey	Grey	Black

* To complete the item number, add the color code (e.g., PRO 60 G).



RONDEC in matte white (page 37)



Schluter®-QUADEC

Schluter®-QUADEC is a finishing and edge-protection profile for tiled edges and outside corners of tiled surfaces. The reveal of the profile forms a square outer corner along the surface edge. QUADEC allows for modern decorative design and interesting contrasts. The profile can be combined with the Schluter®-QUADEC-FS feature strip profile and/or the Schluter®-DESIGNLINE border profile for further design options. QUADEC, in stainless steel, can also be used as a stair nosing or floor transition profile. QUADEC in aluminum and PVC feature an integrated joint spacer that establishes a defined joint cavity between the tile and the profile.

Note: Also available in chrome-plated brass, and stainless steel 316L (1.4404 = V4A). Contact Customer Service for pricing and availability.

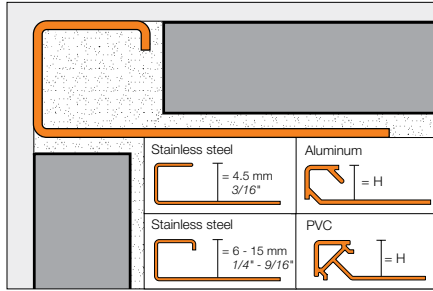

Inside/outside corner/end cap (EV/)

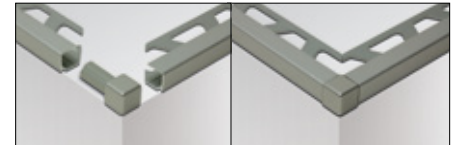
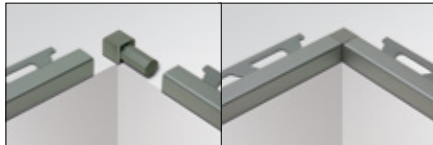

Stainless Steel 304 (1.4301 = V2A)

Schluter®-QUADEC						
Length = 2.5 m - 8' 2-1/2"	Stainless steel 304 (1.4301 = V2A) (E)					
H = mm - in.	Profile	\$ / Length	Inside/outside corner	\$ / Unit	Connector	\$ / Unit
4.5 - 3/16	Q 45 E	45.36	EV/Q 45 E	36.52	-	-
6 - 1/4	Q 60 E	52.08	EV/Q 60 E	40.04	V/RO 60 E	6.58
7 - 9/32	Q 70 E	54.04	EV/Q 70 E	40.60	-	-
8 - 5/16	Q 80 E	54.38	EV/Q 80 E	41.14	V/RO 80 E	6.58
9 - 11/32	Q 90 E	57.98	EV/Q 90 E	42.60	-	-
10 - 3/8	Q 100 E	58.41	EV/Q 100 E	44.43	V/RO 100 E	6.58
11 - 7/16	Q 110 E	60.45	EV/Q 110 E	45.11	V/RO 110 E	6.58
12.5 - 1/2	Q 125 E	62.22	EV/Q 125 E	45.60	V/RO 125 E	6.58
14 - 17/32	Q 140 E	66.64	EV/Q 140 E	47.41	-	-
15 - 9/16	Q 150 E	69.32	EV/Q 150 E	50.85	-	-

Length = 2.5 m - 8' 2-1/2"	Brushed stainless steel 304 (1.4301 = V2A) (EB)					
H = mm - in.	Profile	\$ / Length	Inside/outside corner	\$ / Unit	Connector	\$ / Unit
6 - 1/4	Q 60 EB	76.62	EV/Q 60 EB	48.32	V/RO 60 E	6.58
7 - 9/32	Q 70 EB	79.52	EV/Q 70 EB	48.84	-	-
8 - 5/16	Q 80 EB	82.40	EV/Q 80 EB	49.33	V/RO 80 E	6.58
9 - 11/32	Q 90 EB	85.31	EV/Q 90 EB	51.06	-	-
10 - 3/8	Q 100 EB	88.50	EV/Q 100 EB	53.27	V/RO 100 E	6.58
11 - 7/16	Q 110 EB	91.59	EV/Q 110 EB	54.07	V/RO 110 E	6.58
12.5 - 1/2	Q 125 EB	94.28	EV/Q 125 EB	54.59	V/RO 125 E	6.58
14 - 17/32	Q 140 EB	96.66	EV/Q 140 EB	55.30	-	-
15 - 9/16	Q 150 EB	98.04	EV/Q 150 EB	56.79	-	-



Anodized Aluminum

Schluter®-QUADEC										
Length = 2.5 m - 8' 2-1/2"	Satin anodized aluminum (AE)				Polished chrome anodized aluminum (ACG)				Connector	
H = mm - in.	Profile	\$ / Length	Inside/outside corner	\$ / Unit	Profile	\$ / Length	Inside/outside corner	\$ / Unit	Item No.	\$ / Unit
4.5 - 3/16	Q 45 AE	18.83	EV/Q 45 AE	8.91	Q 45 ACG	23.66	EV/Q 45 ACG	10.58	-	-
6 - 1/4	Q 60 AE	19.62	EV/Q 60 AE	8.91	Q 60 ACG	24.65	EV/Q 60 ACG	10.58	V/Q 60	2.75
8 - 5/16	Q 80 AE	20.46	EV/Q 80 AE	8.91	Q 80 ACG	27.77	EV/Q 80 ACG	10.58	V/RO 80	2.75
10 - 3/8	Q 100 AE	22.12	EV/Q 100 AE	8.91	Q 100 ACG	30.63	EV/Q 100 ACG	10.58	V/RO 100	2.75
12.5 - 1/2	Q 125 AE	24.69	EV/Q 125 AE	8.91	Q 125 ACG	35.88	EV/Q 125 ACG	10.58	V/RO 125	2.75
15 - 9/16	Q 150 AE	27.86	EV/Q 150 AE	10.08	-	-	-	-	-	-
20 - 3/4	Q 200 AE	30.51	EV/Q 200 AE	10.08	-	-	-	-	-	-

Length = 2.5 m - 8' 2-1/2"	Satin nickel anodized aluminum (AT)				Brushed nickel anodized aluminum (ATGB)				Connector	
H = mm - in.	Profile	\$ / Length	Inside/outside corner	\$ / Unit	Profile	\$ / Length	Inside/outside corner	\$ / Unit	Item No.	\$ / Unit
4.5 - 3/16	Q 45 AT	19.84	EV/Q 45 AT	8.75	-	-	-	-	-	-
6 - 1/4	Q 60 AT	20.67	EV/Q 60 AT	8.75	-	-	-	-	V/Q 60	2.75
8 - 5/16	Q 80 AT	22.08	EV/Q 80 AT	8.75	Q 80 ATGB	27.06	EV/Q 80 ATGB	16.19	V/RO 80	2.75
10 - 3/8	Q 100 AT	23.52	EV/Q 100 AT	8.75	Q 100 ATGB	30.11	EV/Q 100 ATGB	16.19	V/RO 100	2.75
12.5 - 1/2	Q 125 AT	26.19	EV/Q 125 AT	8.75	Q 125 ATGB	32.53	EV/Q 125 ATGB	16.19	V/RO 125	2.75

Length = 2.5 m - 8' 2-1/2"	Brushed antique bronze anodized aluminum (ABGB)				Connector	
H = mm - in.	Profile	\$ / Length	Inside/outside corner	\$ / Unit	Item No.	\$ / Unit
6 - 1/4	Q 60 ABGB	26.48	EV/Q 60 ABGB	16.19	V/Q 60	2.75
8 - 5/16	Q 80 ABGB	27.06	EV/Q 80 ABGB	16.19	V/RO 80	2.75
10 - 3/8	Q 100 ABGB	30.11	EV/Q 100 ABGB	16.19	V/RO 100	2.75
12.5 - 1/2	Q 125 ABGB	32.53	EV/Q 125 ABGB	16.19	V/RO 125	2.75

10-foot (3.05 m) QUADEC Profiles – Anodized Aluminum		
Length = 3.05 m - 10'	Polished chrome anodized aluminum (ACG)	
H = mm - in.	Profile	\$ / Length
8 - 5/16	Q 80 ACG / 300	34.73
10 - 3/8	Q 100 ACG / 300	38.29
12.5 - 1/2	Q 125 ACG / 300	44.86

Special shipping conditions apply, see pages 207 - 208.



Schluter®-TRENDLINE Textured Color-coated Aluminum

Schluter®-QUADEC						
Length = 2.5 m - 8' 2-1/2"	Textured color-coated aluminum (TS)					
H = mm - in.	Profile	\$ / Length	Inside/outside corner	\$ / Unit	Connector	\$ / Unit
4.5 - 3/16	Q 45 + color*	42.08	EV/Q 45 + color*	16.82	-	-
6 - 1/4	Q 60 + color*	42.92	EV/Q 60 + color*	16.82	V/Q 60	2.75
8 - 5/16	Q 80 + color*	43.80	EV/Q 80 + color*	16.82	V/RO 80	2.75
10 - 3/8	Q 100 + color*	44.98	EV/Q 100 + color*	16.82	V/RO 100	2.75
11 - 7/16	Q 110 + color*	45.60	EV/Q 110 + color*	16.82	V/RO 110	2.75
12.5 - 1/2	Q 125 + color*	46.04	EV/Q 125 + color*	16.82	V/RO 125	2.75



***Color Codes**

Ivory	Greige	Stone grey	Cream	Beige	Rustic brown	Bronze	Pewter	Light anthracite	Dark anthracite

* To complete the item number, add the color code (e.g., Q 60 TSC).

Matte White and Matte Black

Length = 2.5 m - 8' 2-1/2"	Matte color-coated aluminum					
H = mm - in.	Profile	\$ / Length	Inside/outside corner	\$ / Unit	Connector	\$ / Unit
4.5 - 3/16	Q 45 + color*	33.34	EV/Q 45 + color*	16.82	-	-
6 - 1/4	Q 60 + color*	34.01	EV/Q 60 + color*	16.82	V/Q 60	2.75
8 - 5/16	Q 80 + color*	34.71	EV/Q 80 + color*	16.82	V/RO 80	2.75
10 - 3/8	Q 100 + color*	35.84	EV/Q 100 + color*	16.82	V/RO 100	2.75
11 - 7/16	Q 110 + color*	36.25	EV/Q 110 + color*	16.82	V/RO 110	2.75
12.5 - 1/2	Q 125 + color*	36.61	EV/Q 125 + color*	16.82	V/RO 125	2.75

***Color Codes**

		* To complete the item number, add the color code (e.g., Q 60 MGS).
Matte white	Matte black	

10-foot (3.05 m) QUADEC Profiles – Textured Color-coated Aluminum						
Length = 3.05 m - 10'	Textured color-coated aluminum (TS)		Matte white (MBW)		Matte black (MGS)	
H = mm - in.	Profile	\$ / Length	Profile	\$ / Length	Profile	\$ / Length
6 - 1/4	Q 60 + color* / 300	53.65	Q 60 MBW / 300	42.51	Q 60 MGS / 300	42.51
8 - 5/16	Q 80 + color* / 300	54.74	Q 80 MBW / 300	43.40	Q 80 MGS / 300	43.40
10 - 3/8	Q 100 + color* / 300	56.22	Q 100 MBW / 300	44.80	Q 100 MGS / 300	44.80
11 - 7/16	Q 110 + color* / 300	57.00	Q 110 MBW / 300	45.31	Q 110 MGS / 300	45.31
12.5 - 1/2	Q 125 + color* / 300	57.57	Q 125 MBW / 300	45.75	Q 125 MGS / 300	45.75

Special shipping conditions apply, see pages 207 - 208.



Color-coated Aluminum

Schluter®-QUADEC				
Length = 2.5 m - 8' 2-1/2"	Color-coated aluminum (AC)			
H = mm - in.	Profile	\$/ Length	Outside corner, 90° (die cast)	\$/ Unit
4.5 - 3/16	Q 45 + color*	20.32	ED/Q 45 + color*	4.88
6 - 1/4	Q 60 + color*	21.84	ED/Q 60 + color*	4.88
8 - 5/16	Q 80 + color*	23.10	ED/Q 80 + color*	4.88
10 - 3/8	Q 100 + color*	24.38	ED/Q 100 + color*	4.88
11 - 7/16	Q 110 + color*	25.13	ED/Q 110 + color*	4.88
12.5 - 1/2	Q 125 + color*	26.67	ED/Q 125 + color*	4.88

***Color Codes**

* To complete the item number, add the color code (e.g., Q 45 PG).

PVC

Length = 2.5 m - 8' 2-1/2"	PVC (P)			
H = mm - in.	Profile	\$/ Length	Outside corner, 90°	\$/ Unit
6 - 1/4	PQ 60 + color*	7.97	E/PQ 60 + color*	2.97
8 - 5/16	PQ 80 + color*	8.38	E/PQ 80 + color*	2.97
10 - 3/8	PQ 100 + color*	8.95	E/PQ 100 + color*	2.97
11 - 7/16	PQ 110 + color*	10.08	E/PQ 110 + color*	2.97
12.5 - 1/2	PQ 125 + color*	11.20	E/PQ 125 + color*	2.97

***Color Codes**

* To complete the item number, add the color code (e.g., PQ 80 PG).



QUADEC in cream (page 41)



Schluter®-QUADEC-K

Schluter®-QUADEC-K is a variant of the QUADEC profile without an anchoring leg. It features an open cavity that is filled with thin-set mortar to secure the profile in the assembly. Alternatively, the profile may be installed with an adhesive such as Schluter®-KERDI-FIX. QUADEC-K is installed in wall applications (e.g., wainscotings and bases) with coverings up to 1/2" (12.5 mm) thick. The profile is particularly suited for finishing edges in retrofit applications, such as thin porcelain panel installation over existing wall tiles.

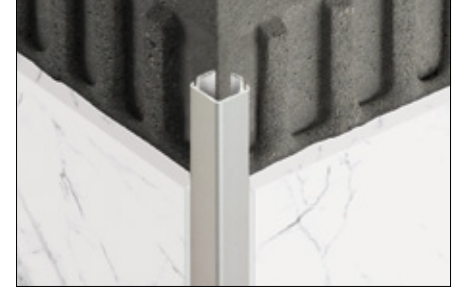
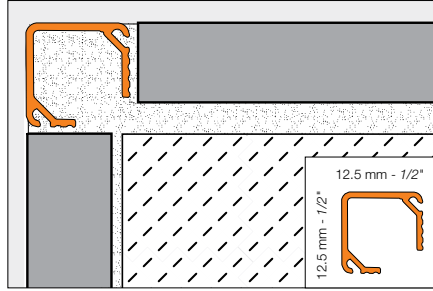

Schluter®-QUADEC-K												
Length = 2.5 m - 8' 2-1/2"	Satin anodized aluminum (AE)						Polished chrome anod. alu. (ACG)					
H = mm - in.	Profile	\$ / Length	Inside/outside corner	\$ / Unit	Connector	\$ / Unit	Profile	\$ / Length	Inside/outside corner	\$ / Unit	Connector	\$ / Unit
12.5 - 1/2	Q 125 AE K	22.66	EV/Q 125 AE	8.91	V/RO 125	2.75	Q 125 ACG K	26.76	EV/Q 125 ACG	10.58	V/RO 125	2.75
Length = 2.5 m - 8' 2-1/2"	Satin nickel anod. alu. (AT)						Brushed antique bronze anod. alu. (ABGB)					
H = mm - in.	Profile	\$ / Length	Inside/outside corner	\$ / Unit	Connector	\$ / Unit	Profile	\$ / Length	Inside/outside corner	\$ / Unit	Connector	\$ / Unit
12.5 - 1/2	Q 125 AT K	24.80	EV/Q 125 AT	8.75	V/RO 125	2.75	Q 125 ABGB K	29.30	EV/Q 125 ABGB	16.19	V/RO 125	2.75

Schluter®-QUADEC-FS

Schluter®-QUADEC-FS is a double-rail feature strip profile that features a recessed section to which field or accent tile is bonded. The profile can be used to produce accents in tile fields on walls, chair rails, and various other decorative applications. The profile can be combined with the Schluter®-QUADEC finishing and edge-protection profile. QUADEC-FS features integrated joint spacers that establish defined joint cavities between the accent tile and the profile.

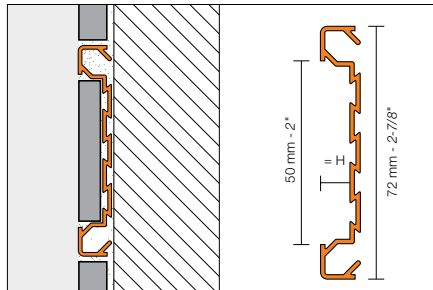

Inside/outside corner / End cap (EV/)



Note: The universal accessory piece can be used to produce a 90° inside corner, 90° outside corner, and end cap.

Schluter®-QUADEC-FS									
Length = 2.5 m - 8' 2-1/2"	Satin anodized aluminum (AE)					Polished chrome anod. alu. (ACG)			
H = mm - in.	Profile	\$ / Length	Inside/outside corner	\$ / Unit	Profile	\$ / Length	Inside/outside corner	\$ / Unit	
8 - 5/16	QF8/50 AE	39.96	EV/QF8/50 AE	26.68	QF8/50 ACG	53.15	EV/QF8/50 ACG	31.59	
Length = 2.5 m - 8' 2-1/2"	Satin nickel anod. alu. (AT)					Brushed antique bronze anod. alu. (ABGB)			
H = mm - in.	Profile	\$ / Length	Inside/outside corner	\$ / Unit	Profile	\$ / Length	Inside/outside corner	\$ / Unit	
8 - 5/16	QF8/50 AT	42.32	EV/QF8/50 AT	26.68	QF8/50 ABGB	57.34	EV/QF8/50 ABGB	34.24	



Schluter®-FINEC-SQ

Schluter®-FINEC-SQ is a finishing and edge-protection profile for outside corners of tile coverings. This minimalistic wall profile features a symmetrical 3/16" (4.5 mm) profile reveal that combines the slim look of Schluter®-FINEC with the square shape of Schluter®-QUADEC and a perforated anchoring leg that is secured in mortar bond coat beneath the tile. This profile is available in larger sizes to accommodate thicker tiles and is ideal for protecting mitered edges. Available in satin anodized aluminum, as well as color-coated aluminum in all TRENDLINE colors.

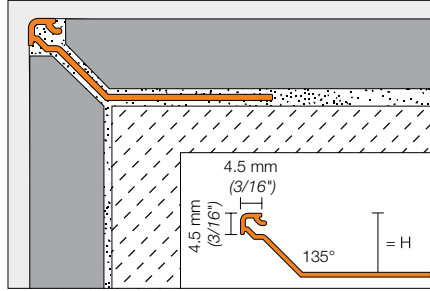

FINEC-SQ can be combined with QUADEC corner pieces

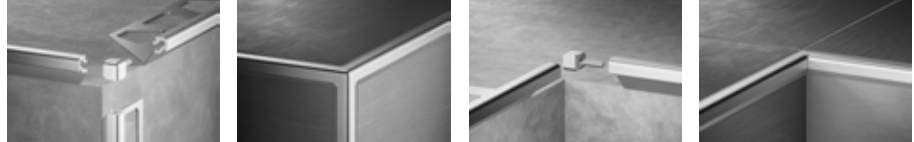

Schluter®-FINEC-SQ				
Length = 2.5 m - 8' 2-1/2"		Satin anodized aluminum (AE)		
H = mm - in.	Profile	\$/ Length	Inside/Outside Corner	\$/ Unit
11 - 7/16	FSQ 110 AE	22.97	EV/Q 45 AE	8.91
12.5 - 1/2	FSQ 125 AE	23.23		
15 - 9/16	FSQ 150 AE	23.29		

Schluter®-FINEC-SQ				
Length = 2.5 m - 8' 2-1/2"		Textured color-coated aluminum		
H = mm - in.	Profile	\$/ Length	Inside/Outside Corner	\$/ Unit
11 - 7/16	FSQ 110 + color*	30.90	EV/Q 45 + color*	16.82
12.5 - 1/2	FSQ 125 + color*	30.98		
15 - 9/16	FSQ 150 + color*	31.08		

Color Codes

TSI Ivory	TSBG Greige	TSSG Stone grey	TSC Cream	TSB Beige	TSR Rustic brown
TSOB Bronze	TSG Pewter	TSLA Light anthracite	TSDA Dark anthracite	MBW Matte white	MGS Matte black

* To complete the item number, add the color code (e.g., FSQ 110 TSC).



FINEC-SQ in matte black



Schluter®-FINEC

Schluter®-FINEC is a finishing and edge-protection profile for the external edges of tile coverings or mosaics. The finishing leg of the profile protects the covering edges from mechanical damage, and features a very slim, elegant reveal. Available in anodized aluminium, color-coated aluminium in all TRENDLINE colors, as well as stainless steel. FINEC is ideal for protecting mitered edges, while creating a discreet trim for a minimalist design.

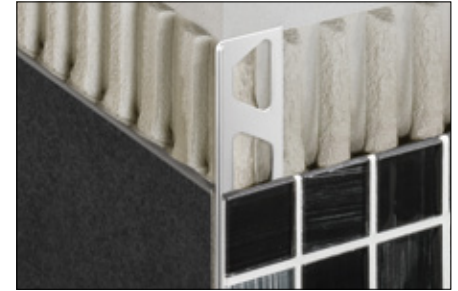
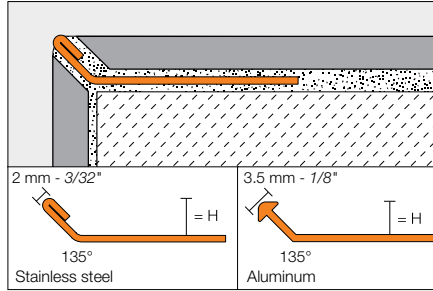

Schluter®-FINEC				
Length = 2.5 m - 8' 2-1/2"	Stainless steel 304 (1.4301 = V2A) (E)		Satin anodized aluminum (AE)	
H = mm - in.	Item No.	\$ / Length	Item No.	\$ / Length
2.5 - 3/32	-	-	F 25 AE	17.54
4.5 - 3/16	F 45 E	34.20	F 45 AE	17.80
7 - 9/32	F 70 E	35.88	F 70 AE	18.51
9 - 11/32	F 90 E	38.24	F 90 AE	19.41
11 - 7/16	F 110 E	39.50	F 110 AE	20.19
12.5 - 1/2	F 125 E	40.24	F 125 AE	20.71

Length = 2.5 m - 8' 2-1/2"	Textured color-coated aluminum		
H = mm - in.	Item No.	\$ / Length	
2.5 - 3/32	F 25 MBW	24.34	
4.5 - 3/16	F 45 + color*	24.83	
7 - 9/32	F 70 + color*	25.35	
9 - 11/32	F 90 + color*	26.42	
11 - 7/16	F 110 + color*	26.68	
12.5 - 1/2	F 125 + color*	27.20	

***Color Codes**

TSI Ivory	TSBG Greige	TSSG Stone grey	TSC Cream	TSB Beige	TSR Rustic brown
TSOB Bronze	TSG Pewter	TSLA Light anthracite	TSDA Dark anthracite	MBW Matte white	MGS Matte black

* To complete the item number, add the **color** code (e.g., F 70 **TSC**).



FINEC in stainless steel



Schluter®-INDEC

Schluter®-INDEC is an anodized aluminum profile for outside corners of tiled surfaces and tiled edges. The reveal of the profile forms a square recessed groove for modern decorative design and interesting contrasts.

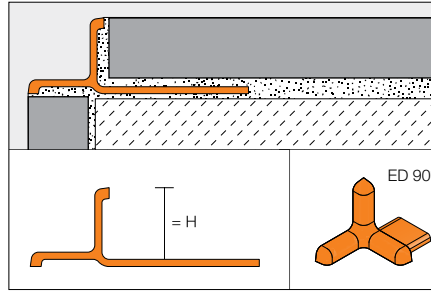

Schluter®-INDEC									
Length = 2.5 m - 8' 2-1/2"		Satin anodized aluminum (AE)		Cast zinc with AE appearance		Polished chrome anod. alu. (ACG)		Cast zinc with ACG appearance	
H = mm - in.		Profile	\$ / Length	Outside corner 90°	\$ / Unit	Profile	\$ / Length	Outside corner 90°	\$ / Unit
8 - 5/16		IN 80 AE	28.04	ED / IN 80 AE	7.59	IN 80 ACG	49.26	ED / IN 80 ACG	7.59
10 - 3/8		IN 100 AE	28.98	ED / IN 100 AE	7.59	IN 100 ACG	50.57	ED / IN 100 ACG	7.59
11 - 7/16		IN 110 AE	29.92	ED / IN 110 AE	7.59	IN 110 ACG	53.62	ED / IN 110 ACG	7.59
12.5 - 1/2		IN 125 AE	35.15	ED / IN 125 AE	7.59	IN 125 ACG	57.20	ED / IN 125 ACG	7.59

Schluter®-DECO-DE

Schluter®-DECO-DE is a stainless steel finishing and edge-protection profile for 135° outside corners of tiled surfaces.

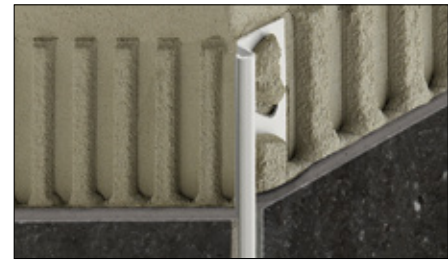
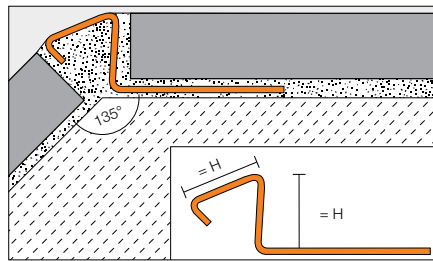

Schluter®-DECO-DE					
Length = 2.5 m - 8' 2-1/2"		Stainless steel 304 (1.4301 = V2A) (E)		Brushed stainless steel 304 (1.4301 = V2A) (EB)	
H = mm - in.		Item No.	\$ / Length	Item No.	\$ / Length
8 - 5/16		DE 80 ES	49.50	DE 80 EBS	54.66
10 - 3/8		DE 100 ES	52.03	DE 100 EBS	57.52
11 - 7/16		DE 110 ES	52.94	DE 110 EBS	58.91
12.5 - 1/2		DE 125 ES	54.42	DE 125 EBS	60.88



Schluter®-RONDEC-DB

Schluter®-RONDEC-DB is a decorative profile for walls, wainscotings, and tile bases. The profile produces a pronounced visible surface that establishes a clean line along tile edges and allows for decorative design. RONDEC-DB can also be used as a finishing profile within wall surfaces. RONDEC-DB features an integrated joint spacer that establishes a defined joint cavity between the tile and the profile.

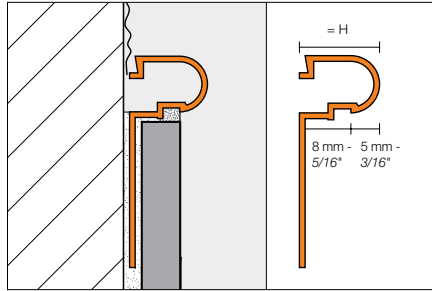

Outside corner (90°)

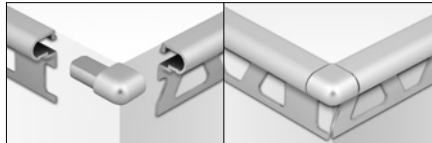

Schluter®-RONDEC-DB

Length = 2.5 m - 8' 2-1/2"	Satin anodized aluminum (AE)				Satin copper anod. alu. (AK)		Satin brass anod. alu. (AM)	
	Profile	\$ / Length	Outside corner, 90°	\$ / Unit	Profile	\$ / Length	Profile	\$ / Length
H = mm - in.								
14 - 17/32	DB 14 AE	33.72	EV/DB 14 AE	13.16	DB 14 AK	35.69	DB 14 AM	33.72

10-foot (3.05 m) RONDEC-DB Profile		
Length = 3.05 m - 10'	Satin anodized aluminum (AE)	
H = mm - in.	Profile	\$ / Length
14 - 17/32	DB 14 AE / 300	42.16

Special shipping conditions apply, see pages 207 - 208.



Schluter®-DESIGNLINE

Schluter®-DESIGNLINE is a border profile for producing decorative designs in tile fields on walls. DESIGNLINE in stainless steel can also be used to produce decorative designs in floors. The profile can be combined with Schluter®-QUADEC and Schluter®-RONDEC finishing and edge-protection profiles. DESIGNLINE in anodized aluminum features an integrated joint spacer that establishes a defined joint cavity between the tile and the profile.

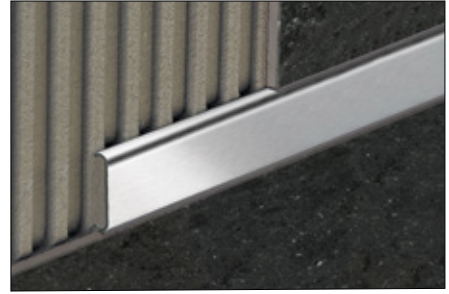
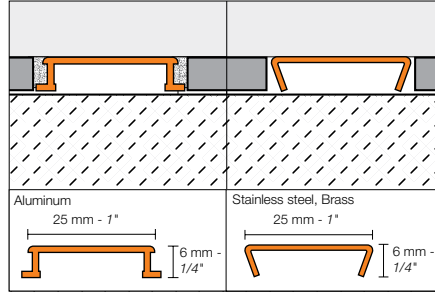

Schluter®-DESIGNLINE						
Length = 2.5 m - 8' 2-1/2"	Stainless steel 304 (1.4301 = V2A) (E)		Brushed stainless steel 304 (1.4301 = V2A) (EB)		Chrome-plated solid brass (MC) *	
H = mm - in.	Item No.	\$ / Length	Item No.	\$ / Length	Item No.	\$ / Length
6 - 1/4	DL 625 E	65.20	DL 625 EB	95.36	DL 625 MC	103.11
Length = 2.5 m - 8' 2-1/2"	Satin anodized aluminum (AE)		Polished chrome anod. alu. (ACG)		Brushed chrome anod. alu. (ACGB)	
H = mm - in.	Item No.	\$ / Length	Item No.	\$ / Length	Item No.	\$ / Length
6 - 1/4	DL 625 AE	28.55	DL 625 ACG	39.30	DL 625 ACGB	45.02
Length = 2.5 m - 8' 2-1/2"	Satin nickel anod. alu. (AT)		Polished nickel anod. alu. (ATG)		Brushed nickel anod. alu. (ATGB)	
H = mm - in.	Item No.	\$ / Length	Item No.	\$ / Length	Item No.	\$ / Length
6 - 1/4	DL 625 AT	29.99	DL 625 ATG	40.70	DL 625 ATGB	46.42
Length = 2.5 m - 8' 2-1/2"	Satin copper anod. alu. (AK)		Polished copper anod. alu. (AKG)		Brushed copper anod. alu. (AKGB)	
H = mm - in.	Item No.	\$ / Length	Item No.	\$ / Length	Item No.	\$ / Length
6 - 1/4	DL 625 AK	29.99	DL 625 AKG	40.70	DL 625 AKGB	46.42
Length = 2.5 m - 8' 2-1/2"	Satin brass anod. alu. (AM)		Polished brass anod. alu. (AMG)		Brushed brass anod. alu. (AMGB)	
H = mm - in.	Item No.	\$ / Length	Item No.	\$ / Length	Item No.	\$ / Length
6 - 1/4	DL 625 AM	28.55	DL 625 AMG	39.30	DL 625 AMGB	45.02

* **WARNING:** Reproductive Harm - www.P65Warnings.ca.gov



Schluter®-DECO-SG

Schluter®-DECO-SG is a decorative profile featuring a 1/2" (12.5 mm) or 9/16" (15 mm) -wide channel that creates a shadow gap between tile courses or other wall covering. The profile may also be used as a support channel for glass panels. The 1/2" (12.5 mm) wide channel accommodates glass panels up to a thickness of 3/8" (10 mm), and the 9/16" (15 mm) wide channel accommodates glass panels up to a thickness of 1/2" (12.5 mm). DECO-SG features a trapezoid-perforated anchoring leg that is secured in the bond coat beneath the tile.

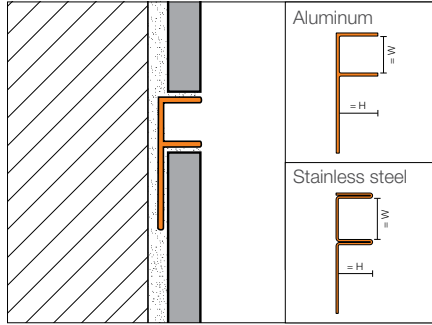

Schluter®-DECO-SG						
Length = 2.5 m - 8' 2-1/2"	Brushed stainless steel 304 (1.4301 = V2A) (EB)		Satin anodized aluminum (AE)		Bright chrome anodized aluminum (ACB)	
H = mm - in.	Item No.	\$ / Length	Item No.	\$ / Length	Item No.	\$ / Length
W: 12.5 mm - 1/2"						
8 - 5/16	SG 80 EB 12	81.58	SG 80 AE 12	22.53	SG 80 ACB 12	23.44
10 - 3/8	SG 100 EB 12	87.13	SG 100 AE 12	23.69	SG 100 ACB 12	24.54
11 - 7/16	SG 110 EB 12	90.13	SG 110 AE 12	24.34	SG 110 ACB 12	25.25
12.5 - 1/2	SG 125 EB 12	94.90	SG 125 AE 12	25.16	SG 125 ACB 12	26.07
W: 15 mm - 9/16"						
8 - 5/16	SG 80 EB 15	84.12	SG 80 AE 15	23.65	SG 80 ACB 15	24.60
10 - 3/8	SG 100 EB 15	89.61	SG 100 AE 15	24.89	SG 100 ACB 15	25.78
11 - 7/16	SG 110 EB 15	92.95	SG 110 AE 15	25.55	SG 110 ACB 15	26.51
12.5 - 1/2	SG 125 EB 15	96.48	SG 125 AE 15	26.43	SG 125 ACB 15	27.40

Schluter®-TRENDLINE Textured Color-coated Aluminum

Length = 2.5 m - 8' 2-1/2"	Textured color-coated aluminum	
H = mm - in.	Item No.	\$ / Length
W: 12.5 mm - 1/2"		
8 - 5/16	SG 80 + color* 12	43.80
10 - 3/8	SG 100 + color* 12	44.98
11 - 7/16	SG 110 + color* 12	45.60
12.5 - 1/2	SG 125 + color* 12	46.04
W: 15 mm - 9/16"		
8 - 5/16	SG 80 + color* 15	45.89
10 - 3/8	SG 100 + color* 15	47.07
11 - 7/16	SG 110 + color* 15	47.70
12.5 - 1/2	SG 125 + color* 15	48.13

***Color Codes**

Ivory	Greige	Stone grey	Cream	Bronze	Pewter	Dark anthracite	Matte white	Matte black

* To complete the item number, add the **color** code (e.g., SG 80 **TSI** 12).



Schluter®-DECO-SGC

Schluter®-DECO-SGC is a decorative profile featuring a 1/2" (12.5 mm) or 9/16" (15 mm) -wide channel used as a vertical support for glass panels in recessed showers that border on untiled walls that are plastered, creating a 90° angle between the glass partition and the untiled wall. The 1/2" (12.5 mm) wide channel accommodates glass panels up to a thickness of 3/8" (10 mm), and the 9/16" (15 mm) wide channel accommodates glass panels up to a thickness of 1/2" (12.5 mm). DECO-SGC features a trapezoid-perforated anchoring leg that is secured in the bond coat beneath the tile.

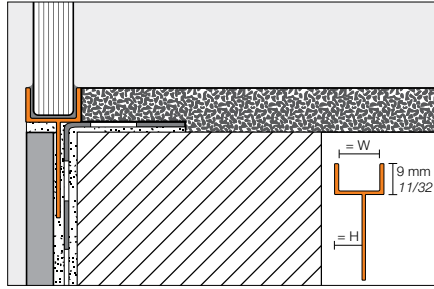

Schluter®-DECO-SGC		
Length = 2.5 m - 8' 2-1/2"	Satin anodized aluminum (AE)	
H = mm - in.	Item No.	\$ / Length
W: 12.5 mm - 1/2"		
8 - 5/16	SGC 80 AE 12	24.34
10 - 3/8	SGC 100 AE 12	25.59
11 - 7/16	SGC 110 AE 12	26.29
12.5 - 1/2	SGC 125 AE 12	27.18
W: 15 mm - 9/16"		
8 - 5/16	SGC 80 AE 15	25.54
10 - 3/8	SGC 100 AE 15	26.88
11 - 7/16	SGC 110 AE 15	27.59
12.5 - 1/2	SGC 125 AE 15	28.55



DECO-SG (page 49)



Schluter®-RONDEC-STEP

Schluter®-RONDEC-STEP is a finishing and edging profile for ceramic tile and dimension stone installations on countertops and stairs. The top of the profile features a symmetrically rounded edge that matches the Schluter®-RONDEC profile, while the vertical leg of the profile hides the exposed edge of the sub-assembly. RONDEC-STEP features an integrated joint spacer that establishes a defined joint cavity between the tile and the profile.

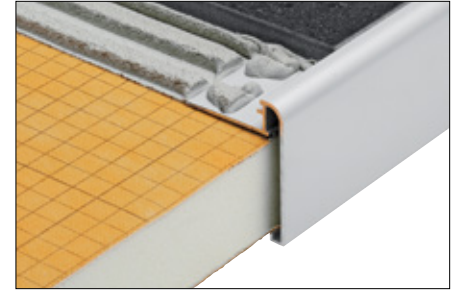
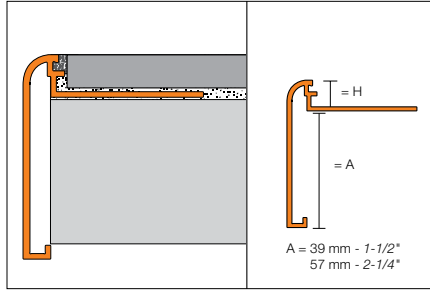

Outside corner (90° or 135°)



Inside corner (90° or 135°)



Schluter®-RONDEC-STEP								
Length = 2.5 m - 8' 2-1/2"	Satin anodized aluminum (AE)							
H = mm - in.	Profile	\$/ Length	Outside corner, 90°	Outside corner, 135°	Inside corner, 90°	Inside corner, 135°	\$/ Unit	
A: 39 mm - 1-1/2"								
8 - 5/16	RS 80 AE 39	48.12	E90 RS 80 AE 39	E135 RS 80 AE 39	I90 RS 80 AE 39	I135 RS 80 AE 39	22.45	
10 - 3/8	RS 100 AE 39	48.91	E90 RS 100 AE 39	E135 RS 100 AE 39	I90 RS 100 AE 39	I135 RS 100 AE 39	22.45	
12.5 - 1/2	RS 125 AE 39	50.57	E90 RS 125 AE 39	E135 RS 125 AE 39	I90 RS 125 AE 39	I135 RS 125 AE 39	22.45	
A: 57 mm - 2-1/4"								
8 - 5/16	RS 80 AE 57	49.37	E90 RS 80 AE 57	E135 RS 80 AE 57	I90 RS 80 AE 57	I135 RS 80 AE 57	22.45	
10 - 3/8	RS 100 AE 57	50.16	E90 RS 100 AE 57	E135 RS 100 AE 57	I90 RS 100 AE 57	I135 RS 100 AE 57	22.45	
12.5 - 1/2	RS 125 AE 57	52.49	E90 RS 125 AE 57	E135 RS 125 AE 57	I90 RS 125 AE 57	I135 RS 125 AE 57	22.45	

Length = 2.5 m - 8' 2-1/2"	Brushed chrome anodized aluminum (ACGB)							
H = mm - in.	Profile	\$/ Length	Outside corner, 90°	Outside corner, 135°	Inside corner, 90°	Inside corner, 135°	\$/ Unit	
A: 39 mm - 1-1/2"								
8 - 5/16	RS 80 ACGB 39	63.01	E90 RS 80 ACGB 39	E135 RS 80 ACGB 39	I90 RS 80 ACGB 39	I135 RS 80 ACGB 39	25.35	
10 - 3/8	RS 100 ACGB 39	63.71	E90 RS 100 ACGB 39	E135 RS 100 ACGB 39	I90 RS 100 ACGB 39	I135 RS 100 ACGB 39	25.35	
12.5 - 1/2	RS 125 ACGB 39	65.90	E90 RS 125 ACGB 39	E135 RS 125 ACGB 39	I90 RS 125 ACGB 39	I135 RS 125 ACGB 39	25.35	
A: 57 mm - 2-1/4"								
8 - 5/16	RS 80 ACGB 57	64.17	E90 RS 80 ACGB 57	E135 RS 80 ACGB 57	I90 RS 80 ACGB 57	I135 RS 80 ACGB 57	25.35	
10 - 3/8	RS 100 ACGB 57	64.89	E90 RS 100 ACGB 57	E135 RS 100 ACGB 57	I90 RS 100 ACGB 57	I135 RS 100 ACGB 57	25.35	
12.5 - 1/2	RS 125 ACGB 57	67.05	E90 RS 125 ACGB 57	E135 RS 125 ACGB 57	I90 RS 125 ACGB 57	I135 RS 125 ACGB 57	25.35	

Length = 2.5 m - 8' 2-1/2"	Satin nickel anodized aluminum (AT)							
H = mm - in.	Profile	\$/ Length	Outside corner, 90°	Outside corner, 135°	Inside corner, 90°	Inside corner, 135°	\$/ Unit	
A: 39 mm - 1-1/2"								
8 - 5/16	RS 80 AT 39	48.12	E90 RS 80 AT 39	E135 RS 80 AT 39	I90 RS 80 AT 39	I135 RS 80 AT 39	22.45	
10 - 3/8	RS 100 AT 39	48.91	E90 RS 100 AT 39	E135 RS 100 AT 39	I90 RS 100 AT 39	I135 RS 100 AT 39	22.45	
12.5 - 1/2	RS 125 AT 39	50.57	E90 RS 125 AT 39	E135 RS 125 AT 39	I90 RS 125 AT 39	I135 RS 125 AT 39	22.45	
A: 57 mm - 2-1/4"								
8 - 5/16	RS 80 AT 57	49.37	E90 RS 80 AT 57	E135 RS 80 AT 57	I90 RS 80 AT 57	I135 RS 80 AT 57	22.45	
10 - 3/8	RS 100 AT 57	50.16	E90 RS 100 AT 57	E135 RS 100 AT 57	I90 RS 100 AT 57	I135 RS 100 AT 57	22.45	
12.5 - 1/2	RS 125 AT 57	52.49	E90 RS 125 AT 57	E135 RS 125 AT 57	I90 RS 125 AT 57	I135 RS 125 AT 57	22.45	



Schluter®-RONDEC-STEP							
Length = 2.5 m - 8' 2-1/2"	Brushed nickel anodized aluminum (ATGB)						
H = mm - in.	Profile	\$ / Length	Outside corner, 90°	Outside corner, 135°	Inside corner, 90°	Inside corner, 135°	\$ / Unit
A: 39 mm - 1-1/2"							
8 - 5/16	RS 80 ATGB 39	63.01	E90 RS 80 ATGB 39	E135 RS 80 ATGB 39	I90 RS 80 ATGB 39	I135 RS 80 ATGB 39	25.35
10 - 3/8	RS 100 ATGB 39	63.71	E90 RS 100 ATGB 39	E135 RS 100 ATGB 39	I90 RS 100 ATGB 39	I135 RS 100 ATGB 39	25.35
12.5 - 1/2	RS 125 ATGB 39	65.90	E90 RS 125 ATGB 39	E135 RS 125 ATGB 39	I90 RS 125 ATGB 39	I135 RS 125 ATGB 39	25.35

Length = 2.5 m - 8' 2-1/2"	Satin copper anodized aluminum (AK)						
H = mm - in.	Profile	\$ / Length	Outside corner, 90°	Outside corner, 135°	Inside corner, 90°	Inside corner, 135°	\$ / Unit
A: 39 mm - 1-1/2"							
8 - 5/16	RS 80 AK 39	48.12	E90 RS 80 AK 39	E135 RS 80 AK 39	I90 RS 80 AK 39	I135 RS 80 AK 39	22.45
10 - 3/8	RS 100 AK 39	48.91	E90 RS 100 AK 39	E135 RS 100 AK 39	I90 RS 100 AK 39	I135 RS 100 AK 39	22.45
12.5 - 1/2	RS 125 AK 39	50.57	E90 RS 125 AK 39	E135 RS 125 AK 39	I90 RS 125 AK 39	I135 RS 125 AK 39	22.45
A: 57 mm - 2-1/4"							
8 - 5/16	RS 80 AK 57	49.37	E90 RS 80 AK 57	E135 RS 80 AK 57	I90 RS 80 AK 57	I135 RS 80 AK 57	22.45
10 - 3/8	RS 100 AK 57	50.16	E90 RS 100 AK 57	E135 RS 100 AK 57	I90 RS 100 AK 57	I135 RS 100 AK 57	22.45
12.5 - 1/2	RS 125 AK 57	52.49	E90 RS 125 AK 57	E135 RS 125 AK 57	I90 RS 125 AK 57	I135 RS 125 AK 57	22.45

Length = 2.5 m - 8' 2-1/2"	Brushed copper anodized aluminum (AKGB)						
H = mm - in.	Profile	\$ / Length	Outside corner, 90°	Outside corner, 135°	Inside corner, 90°	Inside corner, 135°	\$ / Unit
A: 39 mm - 1-1/2"							
8 - 5/16	RS 80 AKGB 39	63.01	E90 RS 80 AKGB 39	E135 RS 80 AKGB 39	I90 RS 80 AKGB 39	I135 RS 80 AKGB 39	25.35
10 - 3/8	RS 100 AKGB 39	63.71	E90 RS 100 AKGB 39	E135 RS 100 AKGB 39	I90 RS 100 AKGB 39	I135 RS 100 AKGB 39	25.35
12.5 - 1/2	RS 125 AKGB 39	65.90	E90 RS 125 AKGB 39	E135 RS 125 AKGB 39	I90 RS 125 AKGB 39	I135 RS 125 AKGB 39	25.35
A: 57 mm - 2-1/4"							
8 - 5/16	RS 80 AKGB 57	64.17	E90 RS 80 AKGB 57	E135 RS 80 AKGB 57	I90 RS 80 AKGB 57	I135 RS 80 AKGB 57	25.35
10 - 3/8	RS 100 AKGB 57	64.89	E90 RS 100 AKGB 57	E135 RS 100 AKGB 57	I90 RS 100 AKGB 57	I135 RS 100 AKGB 57	25.35
12.5 - 1/2	RS 125 AKGB 57	67.05	E90 RS 125 AKGB 57	E135 RS 125 AKGB 57	I90 RS 125 AKGB 57	I135 RS 125 AKGB 57	25.35

Length = 2.5 m - 8' 2-1/2"	Satin brass anodized aluminum (AM)						
H = mm - in.	Profile	\$ / Length	Outside corner, 90°	Outside corner, 135°	Inside corner, 90°	Inside corner, 135°	\$ / Unit
A: 57 mm - 2-1/4"							
8 - 5/16	RS 80 AM 57	49.37	E90 RS 80 AM 57	E135 RS 80 AM 57	I90 RS 80 AM 57	I135 RS 80 AM 57	22.45
10 - 3/8	RS 100 AM 57	50.16	E90 RS 100 AM 57	E135 RS 100 AM 57	I90 RS 100 AM 57	I135 RS 100 AM 57	22.45
12.5 - 1/2	RS 125 AM 57	52.49	E90 RS 125 AM 57	E135 RS 125 AM 57	I90 RS 125 AM 57	I135 RS 125 AM 57	22.45

Length = 2.5 m - 8' 2-1/2"	Brushed brass anodized aluminum (AMGB)						
H = mm - in.	Profile	\$ / Length	Outside corner, 90°	Outside corner, 135°	Inside corner, 90°	Inside corner, 135°	\$ / Unit
A: 39 mm - 1-1/2"							
8 - 5/16	RS 80 AMGB 39	63.01	E90 RS 80 AMGB 39	E135 RS 80 AMGB 39	I90 RS 80 AMGB 39	I135 RS 80 AMGB 39	25.35
10 - 3/8	RS 100 AMGB 39	63.71	E90 RS 100 AMGB 39	E135 RS 100 AMGB 39	I90 RS 100 AMGB 39	I135 RS 100 AMGB 39	25.35
12.5 - 1/2	RS 125 AMGB 39	65.90	E90 RS 125 AMGB 39	E135 RS 125 AMGB 39	I90 RS 125 AMGB 39	I135 RS 125 AMGB 39	25.35
A: 57 mm - 2-1/4"							
8 - 5/16	RS 80 AMGB 57	64.17	E90 RS 80 AMGB 57	E135 RS 80 AMGB 57	I90 RS 80 AMGB 57	I135 RS 80 AMGB 57	25.35
10 - 3/8	RS 100 AMGB 57	64.89	E90 RS 100 AMGB 57	E135 RS 100 AMGB 57	I90 RS 100 AMGB 57	I135 RS 100 AMGB 57	25.35
12.5 - 1/2	RS 125 AMGB 57	67.05	E90 RS 125 AMGB 57	E135 RS 125 AMGB 57	I90 RS 125 AMGB 57	I135 RS 125 AMGB 57	25.35



Schluter®-RONDEC-STEP							
Length = 2.5 m - 8' 2-1/2"	Brushed antique bronze anodized aluminum (ABGB)						
H = mm - in.	Profile	\$/ Length	Outside corner, 90°	Outside corner, 135°	Inside corner, 90°	Inside corner, 135°	\$/ Unit
A: 39 mm - 1-1/2"							
8 - 5/16	RS 80 ABGB 39	63.01	E90 RS 80 ABGB 39	E135 RS 80 ABGB 39	I90 RS 80 ABGB 39	I135 RS 80 ABGB 39	25.35
10 - 3/8	RS 100 ABGB 39	63.71	E90 RS 100 ABGB 39	E135 RS 100 ABGB 39	I90 RS 100 ABGB 39	I135 RS 100 ABGB 39	25.35
12.5 - 1/2	RS 125 ABGB 39	65.90	E90 RS 125 ABGB 39	E135 RS 125 ABGB 39	I90 RS 125 ABGB 39	I135 RS 125 ABGB 39	25.35

Schluter®-RONDEC-CT

Schluter®-RONDEC-CT is a double-rail edging profile for countertops to be fitted with a ceramic or dimension stone tile covering. The face of the profile features a recessed section to which field or accent tile is bonded. The top and bottom edges of the profile are symmetrically rounded and match the Schluter®-RONDEC profile. RONDEC-CT features an integrated joint spacer that establishes a defined joint cavity between the tile and the profile.

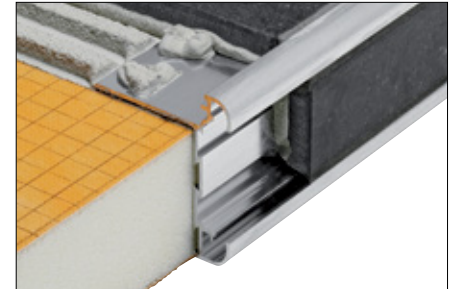
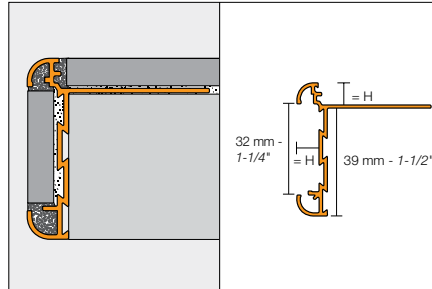

Outside corner (90° or 135°)

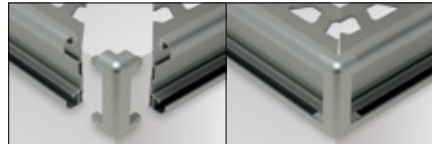

Inside corner (90° or 135°)



Schluter®-RONDEC-CT							
Length = 2.5 m - 8' 2-1/2"	Satin anodized aluminum (AE)						
H = mm - in.	Profile	\$/ Length	Outside corner, 90°	Outside corner, 135°	Inside corner, 90°	Inside corner, 135°	\$/ Unit
8 - 5/16	RC 80 AE 39	53.26	E90 RC 80 AE 39	E135 RC 80 AE 39	I90 RC 80 AE 39	I135 RC 80 AE 39	27.94
10 - 3/8	RC 100 AE 39	54.18	E90 RC 100 AE 39	E135 RC 100 AE 39	I90 RC 100 AE 39	I135 RC 100 AE 39	27.94
12.5 - 1/2	RC 125 AE 39	56.67	E90 RC 125 AE 39	E135 RC 125 AE 39	I90 RC 125 AE 39	I135 RC 125 AE 39	27.94

Schluter®-RONDEC-CT							
Length = 2.5 m - 8' 2-1/2"	Brushed chrome anodized aluminum (ACGB)						
H = mm - in.	Profile	\$/ Length	Outside corner, 90°	Outside corner, 135°	Inside corner, 90°	Inside corner, 135°	\$/ Unit
8 - 5/16	RC 80 ACGB 39	60.54	E90 RC 80 ACGB 39	E135 RC 80 ACGB 39	I90 RC 80 ACGB 39	I135 RC 80 ACGB 39	32.18
10 - 3/8	RC 100 ACGB 39	60.87	E90 RC 100 ACGB 39	E135 RC 100 ACGB 39	I90 RC 100 ACGB 39	I135 RC 100 ACGB 39	32.18
12.5 - 1/2	RC 125 ACGB 39	63.00	E90 RC 125 ACGB 39	E135 RC 125 ACGB 39	I90 RC 125 ACGB 39	I135 RC 125 ACGB 39	32.18

Schluter®-RONDEC-CT							
Length = 2.5 m - 8' 2-1/2"	Satin nickel anodized aluminum (AT)						
H = mm - in.	Profile	\$/ Length	Outside corner, 90°	Outside corner, 135°	Inside corner, 90°	Inside corner, 135°	\$/ Unit
8 - 5/16	RC 80 AT 39	58.35	E90 RC 80 AT 39	E135 RC 80 AT 39	I90 RC 80 AT 39	I135 RC 80 AT 39	27.94
10 - 3/8	RC 100 AT 39	59.64	E90 RC 100 AT 39	E135 RC 100 AT 39	I90 RC 100 AT 39	I135 RC 100 AT 39	27.94
12.5 - 1/2	RC 125 AT 39	62.14	E90 RC 125 AT 39	E135 RC 125 AT 39	I90 RC 125 AT 39	I135 RC 125 AT 39	27.94



Schluter®-RONDEC-CT							
Length = 2.5 m - 8' 2-1/2"	Brushed nickel anodized aluminum (ATGB)						
H = mm - in.	Profile	\$ / Length	Outside corner, 90°	Outside corner, 135°	Inside corner, 90°	Inside corner, 135°	\$ / Unit
8 - 5/16	RC 80 ATGB 39	63.41	E90 RC 80 ATGB 39	E135 RC 80 ATGB 39	I90 RC 80 ATGB 39	I135 RC 80 ATGB 39	32.18
10 - 3/8	RC 100 ATGB 39	64.64	E90 RC 100 ATGB 39	E135 RC 100 ATGB 39	I90 RC 100 ATGB 39	I135 RC 100 ATGB 39	32.18
12.5 - 1/2	RC 125 ATGB 39	65.09	E90 RC 125 ATGB 39	E135 RC 125 ATGB 39	I90 RC 125 ATGB 39	I135 RC 125 ATGB 39	32.18

Length = 2.5 m - 8' 2-1/2"	Satin copper anodized aluminum (AK)						
H = mm - in.	Profile	\$ / Length	Outside corner, 90°	Outside corner, 135°	Inside corner, 90°	Inside corner, 135°	\$ / Unit
8 - 5/16	RC 80 AK 39	58.35	E90 RC 80 AK 39	E135 RC 80 AK 39	I90 RC 80 AK 39	I135 RC 80 AK 39	27.94
10 - 3/8	RC 100 AK 39	59.64	E90 RC 100 AK 39	E135 RC 100 AK 39	I90 RC 100 AK 39	I135 RC 100 AK 39	27.94
12.5 - 1/2	RC 125 AK 39	62.14	E90 RC 125 AK 39	E135 RC 125 AK 39	I90 RC 125 AK 39	I135 RC 125 AK 39	27.94

Length = 2.5 m - 8' 2-1/2"	Brushed copper anodized aluminum (AKGB)						
H = mm - in.	Profile	\$ / Length	Outside corner, 90°	Outside corner, 135°	Inside corner, 90°	Inside corner, 135°	\$ / Unit
8 - 5/16	RC 80 AKGB 39	63.41	E90 RC 80 AKGB 39	E135 RC 80 AKGB 39	I90 RC 80 AKGB 39	I135 RC 80 AKGB 39	32.18
10 - 3/8	RC 100 AKGB 39	64.64	E90 RC 100 AKGB 39	E135 RC 100 AKGB 39	I90 RC 100 AKGB 39	I135 RC 100 AKGB 39	32.18
12.5 - 1/2	RC 125 AKGB 39	65.09	E90 RC 125 AKGB 39	E135 RC 125 AKGB 39	I90 RC 125 AKGB 39	I135 RC 125 AKGB 39	32.18

Length = 2.5 m - 8' 2-1/2"	Satin brass anodized aluminum (AM)						
H = mm - in.	Profile	\$ / Length	Outside corner, 90°	Outside corner, 135°	Inside corner, 90°	Inside corner, 135°	\$ / Unit
8 - 5/16	RC 80 AM 39	54.97	E90 RC 80 AM 39	E135 RC 80 AM 39	I90 RC 80 AM 39	I135 RC 80 AM 39	27.94
10 - 3/8	RC 100 AM 39	56.28	E90 RC 100 AM 39	E135 RC 100 AM 39	I90 RC 100 AM 39	I135 RC 100 AM 39	27.94
12.5 - 1/2	RC 125 AM 39	58.77	E90 RC 125 AM 39	E135 RC 125 AM 39	I90 RC 125 AM 39	I135 RC 125 AM 39	27.94

Length = 2.5 m - 8' 2-1/2"	Brushed brass anodized aluminum (AMGB)						
H = mm - in.	Profile	\$ / Length	Outside corner, 90°	Outside corner, 135°	Inside corner, 90°	Inside corner, 135°	\$ / Unit
8 - 5/16	RC 80 AMGB 39	60.54	E90 RC 80 AMGB 39	E135 RC 80 AMGB 39	I90 RC 80 AMGB 39	I135 RC 80 AMGB 39	32.18
10 - 3/8	RC 100 AMGB 39	60.87	E90 RC 100 AMGB 39	E135 RC 100 AMGB 39	I90 RC 100 AMGB 39	I135 RC 100 AMGB 39	32.18
12.5 - 1/2	RC 125 AMGB 39	63.00	E90 RC 125 AMGB 39	E135 RC 125 AMGB 39	I90 RC 125 AMGB 39	I135 RC 125 AMGB 39	32.18

Schluter®-TRENDLINE Textured Color-coated Aluminum

Length = 2.5 m - 8' 2-1/2"	Textured color-coated aluminum (TS)	
H = mm - in.	Profile	\$ / Length
8 - 5/16	RC 80 + color* 39	79.15
10 - 3/8	RC 100 + color* 39	83.45
12.5 - 1/2	RC 125 + color* 39	85.48

***Color Codes**



TSB
Beige



TSOB
Bronze



TSG
Pewter

* To complete the item number, add the color code (e.g., RC 80 **TSB** 39).

Length = 2.5 m - 8' 2-1/2"	Textured color-coated aluminum (TS)				
H = mm - in.	Outside corner, 90°	Outside corner, 135°	Inside corner, 90°	Inside corner, 135°	\$ / Unit
8 - 5/16	E90 RC 80 + color* 39	E135 RC 80 + color* 39	I90 RC 80 + color* 39	I135 RC 80 + color* 39	33.79
10 - 3/8	E90 RC 100 + color* 39	E135 RC 100 + color* 39	I90 RC 100 + color* 39	I135 RC 100 + color* 39	33.79
12.5 - 1/2	E90 RC 125 + color* 39	E135 RC 125 + color* 39	I90 RC 125 + color* 39	I135 RC 125 + color* 39	33.79



Schluter®-SCHIENE-STEP

Schluter®-SCHIENE-STEP is a finishing and edging profile for ceramic tile and natural stone installations on countertops, stairs, and tile over tile applications on walls. The top of the profile features a vertical wall section that finishes and protects the tile from damage, while the vertical leg covers the edge of the sub-assembly, top of the riser, or existing wall tile edge.

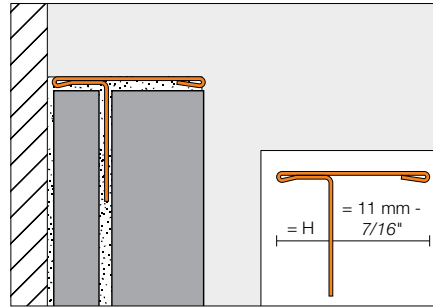
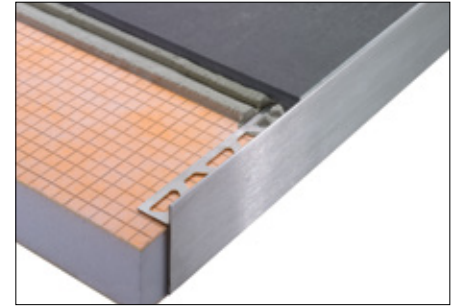
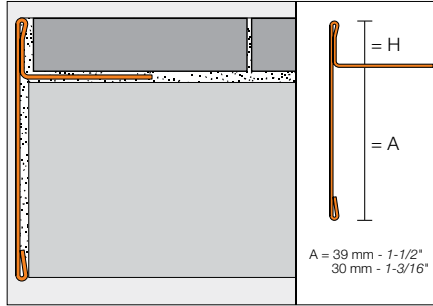

Schluter®-SCHIENE-STEP							
Length = 2.5 m - 8' 2-1/2"	Brushed Stainless Steel 304 (1.4301 = V2A) (EB)						
H = mm - in.	Profile	\$ / Length	Inside corner, 90°	Inside corner, 135°	Outside corner, 90° and End Cap	Outside corner, 135°	\$ / Unit
A: 39 mm - 1-1/2"							
6 - 1/4	SS 60 EB 39	145.96	I90 / SS 60 EB 39	I135 / SS 60 EB 39	E90 / SS 60 EB 39	E135 / SS 60 EB 39	19.28
9 - 11/32	SS 90 EB 39	152.02	I90 / SS 90 EB 39	I135 / SS 90 EB 39	E90 / SS 90 EB 39	E135 / SS 90 EB 39	19.28
11 - 7/16	SS 110 EB 39	154.76	I90 / SS 110 EB 39	I135 / SS 110 EB 39	E90 / SS 110 EB 39	E135 / SS 110 EB 39	19.28
12.5 - 1/2	SS 125 EB 39	157.20	I90 / SS 125 EB 39	I135 / SS 125 EB 39	E90 / SS 125 EB 39	E135 / SS 125 EB 39	19.28
A: 30 mm - 1-3/16"							
9 - 11/32	SS 90 EB 30	114.94	-	-	E90 / SS 90 EB 30	-	19.28
11 - 7/16	SS 110 EB 30	116.41	-	-	E90 / SS 110 EB 30	-	19.28
12.5 - 1/2	SS 125 EB 30	117.89	-	-	E90 / SS 125 EB 30	-	19.28
A: 11 mm - 7/16"							
6 - 1/4	SS 60 EB 11	110.58					
12.5 - 1/2	SS 125 EB 11	112.01					

Brushed Stainless Steel 304 (1.4301 = V2A) (EB)		
H = mm - in.	Connector	\$ / Unit
A: 39 mm - 1-1/2"		
6 - 1/4	V / SS 60 EB 39	16.39
9 - 11/32	V / SS 90 EB 39	16.39
11 - 7/16	V / SS 110 EB 39	16.39
12.5 - 1/2	V / SS 125 EB 39	16.39
A: 30 mm - 1-3/16"		
9 - 11/32	V / SS 90 EB 30	16.39
11 - 7/16	V / SS 110 EB 30	16.39
12.5 - 1/2	V / SS 125 EB 30	16.39
A: 11 mm - 7/16"		
6 - 1/4	V / SS 60 EB 11	16.39
12.5 - 1/2	V / SS 125 EB 11	16.39

Note: The anchoring leg of **Schluter®-SCHIENE-STEP** is available with a special radius perforation so that the profile can be used to form curves.

- Price surcharge: \$0.70 per foot
- Item No.: R / Profile No. (e.g., R/SS 60 EB 11)
- For delivery time, please call Customer Service





Schluter®-ECK-E

Schluter®-ECK-E is a stainless steel edging profile for outside corners of tiled walls that offers excellent edge protection against mechanical stresses in commercial/industrial applications. The profile produces a radiused edge along the outside wall corner for a clean, decorative finish. ECK-E is installed simultaneously with the tile, while ECK-K is subsequently installed on the outside corners of existing installations.

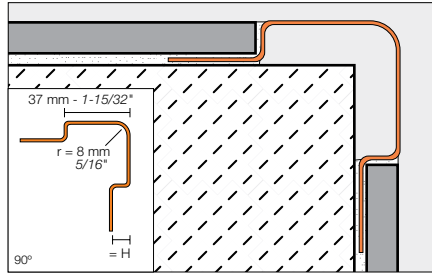

Note: ECK-E is also available in stainless steel 316L (1.4404 = V4A). Contact Customer Service for price and availability.

Schluter®-ECK-E				
H = mm - in.	Stainless steel 304 (1.4301 = V2A) (E)		Brushed stainless steel 304 (1.4301 = V2A) (EB)	
	Item No.	\$ / Length	Item No.	\$ / Length
90° Angle				
Length = 1.50 m - 4' 11"				
6 - 1/4	E37 V2A 60/150	63.13	E37 V2A EB 60/150	82.05
8 - 5/16	E37 V2A 80/150	65.65	E37 V2A EB 80/150	85.33
11 - 7/16	E37 V2A 110/150	68.27	E37 V2A EB 110/150	88.73
Length = 2.00 m - 6' 7"				
6 - 1/4	E37 V2A 60/200	81.09	E37 V2A EB 60/200	105.45
8 - 5/16	E37 V2A 80/200	84.31	E37 V2A EB 80/200	109.65
11 - 7/16	E37 V2A 110/200	87.80	E37 V2A EB 110/200	114.16
Length = 2.5 m - 8' 2-1/2"				
6 - 1/4	E37 V2A 60/250	99.06	E37 V2A EB 60/250	128.76
8 - 5/16	E37 V2A 80/250	103.03	E37 V2A EB 80/250	133.93
11 - 7/16	E37 V2A 110/250	107.39	E37 V2A EB 110/250	139.60
Length = 3.00 m - 9' 10"				
6 - 1/4	E37 V2A 60/300	122.40	E37 V2A EB 60/300	159.16
8 - 5/16	E37 V2A 80/300	129.14	E37 V2A EB 80/300	167.89
11 - 7/16	E37 V2A 110/300	133.63	E37 V2A EB 110/300	173.77



Schluter®-ECK-K

Schluter®-ECK-K is a stainless steel edging profile for outside corners of tiled walls that offers excellent edge protection against mechanical stresses in commercial/ industrial applications. The profile produces a radiused edge along the outside wall corner for a clean, decorative finish. ECK-K is subsequently bonded to the outside corners of existing installations. As such, ECK-K can be installed as a repair so that existing, damaged corners do not have to be replaced.

Note: ECK-K is also available in stainless steel 316L (1.4404 = V4A). Contact Customer Service for price and availability.

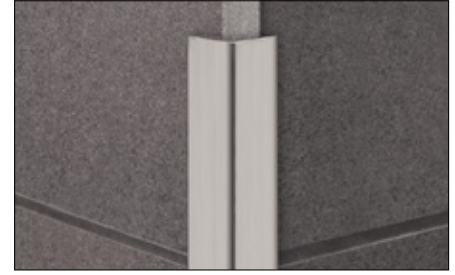
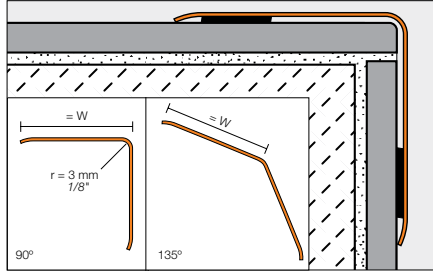

Schluter®-ECK-K				
W = mm - in.	Stainless steel 304 (1.4301 = V2A) (E)		Brushed stainless steel 304 (1.4301 = V2A) (EB)	
	Item No.	\$ / Length	Item No.	\$ / Length
90° Angle				
Length = 1.50 m - 4' 11"				
15 - 9/16	K15 V2A/150	37.31	K15 V2A EB/150	48.52
32 - 1-9/32	K32 V2A/150	61.38	K32 V2A EB/150	79.84
50 - 2	K50 V2A/150	78.99	K50 V2A EB/150	102.73
Length = 2.00 m - 6' 7"				
32 - 1-9/32	K32 V2A/200	81.97	K32 V2A EB/200	106.51
50 - 2	K50 V2A/200	105.33	K50 V2A EB/200	136.91
Length = 2.5 m - 8' 2-1/2"				
15 - 9/16	K15 V2A/250	62.14	K15 V2A EB/250	80.88
32 - 1-9/32	K32 V2A/250	102.36	K32 V2A EB/250	133.10
50 - 2	K50 V2A/250	131.65	K50 V2A EB/250	171.11
Length = 3.00 m - 9' 10"				
15 - 9/16	K15 V2A/300	74.56	K15 V2A EB/300	96.92
32 - 1-9/32	K32 V2A/300	124.27	K32 V2A EB/300	161.49
50 - 2	K50 V2A/300	157.11	K50 V2A EB/300	204.22
135° Angle				
Length = 1.50 m - 4' 11"				
32 - 1-9/32	K32 ES/150	59.60		
Length = 2.5 m - 8' 2-1/2"				
32 - 1-9/32	K32 ES	99.27		
Length = 3.00 m - 9' 10"				
32 - 1-9/32	K32 ES/300	119.13		



Schluter®-ECK-KHK

Schluter®-ECK-KHK is a stainless steel profile for inside wall corners that produces a radiused edge for a clean, decorative finish. ECK-KHK provides a 5/16" (8 mm) radius to prevent the accumulation of dirt and make cleaning simple. Thus, the profile is especially suited for commercial kitchens, bathrooms, food processing plants or any environment where a sanitary corner is desired. ECK-KHK is subsequently bonded to the inside corners of existing tile or other wall coverings. As such, the profile can be installed as a repair so that existing, damaged corners do not have to be replaced.

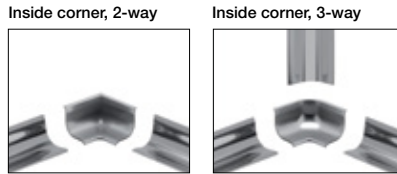
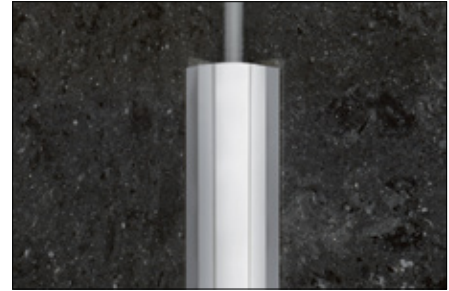
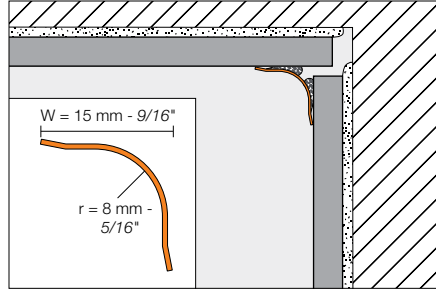

Schluter®-ECK-KHK						
Stainless steel 304 (1.4301 = V2A) (E)						
W = mm - in.	Profile	\$ / Length	Outside corner, 90°	Inside corner, 90° (2-way)	Inside corner, 90° (3-way)	\$ / Unit
Length = 1.50 m - 4' 11"			E/KHK 15 E	1/2KHK 15 E	1/3KHK 15 E	10.92
15 - 9/16	KHK 15 E/150	25.66				
Length = 2.00 m - 6' 7"						
15 - 9/16	KHK 15 E/200	34.21				
Length = 2.5 m - 8' 2-1/2"						
15 - 9/16	KHK 15 E	42.77				
Length = 3.00 m - 9' 10"			V/KHK 15 E			7.42
15 - 9/16	KHK 15 E/300	51.32				
Connector						

Brushed stainless steel 304 (1.4301 = V2A) (EB)						
W = mm - in.	Profile	\$ / Length	Outside corner, 90°	Inside corner, 90° (2-way)	Inside corner, 90° (3-way)	\$ / Unit
Length = 1.50 m - 4' 11"			E/KHK 15 EB	1/2KHK 15 EB	1/3KHK 15 EB	10.92
15 - 9/16	KHK 15 EB/150	28.82				
Length = 2.00 m - 6' 7"						
15 - 9/16	KHK 15 EB/200	38.41				
Length = 2.5 m - 8' 2-1/2"						
15 - 9/16	KHK 15 EB	48.03				
Length = 3.00 m - 9' 10"			V/KHK 15 EB			7.42
15 - 9/16	KHK 15 EB/300	57.64				
Connector						



Schluter®-DESIGNBASE-SL

The **Schluter®-DESIGNBASE-SL** profile provides a modern alternative to traditional baseboards. The profile is available in brushed stainless steel, anodized aluminum, and color-coated aluminum. DESIGNBASE features a clean, sleek look, and is simply attached to the wall with a suitable adhesive. An optional sealing lip accessory is available to protect the floor/wall transition from moisture penetration and to reduce the transmission of impact sound.

The brushed stainless steel profile is available in 4-3/8" or 6-3/8" (110 or 160 mm) heights to meet code requirements for a commercial cove base.

The anodized and color-coated aluminum profiles are available in 2-3/8" or 3-1/8" (60 or 80 mm) heights.

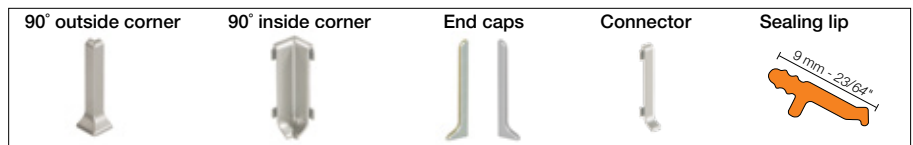
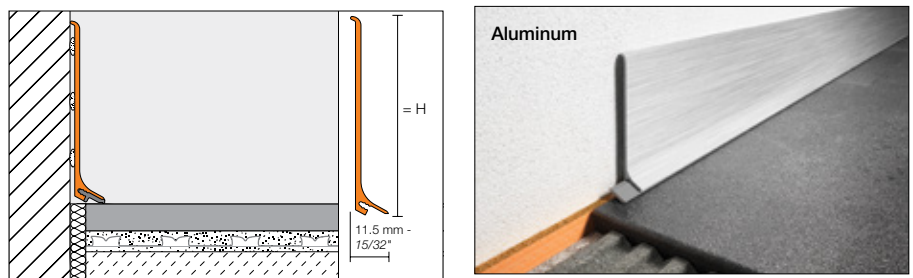
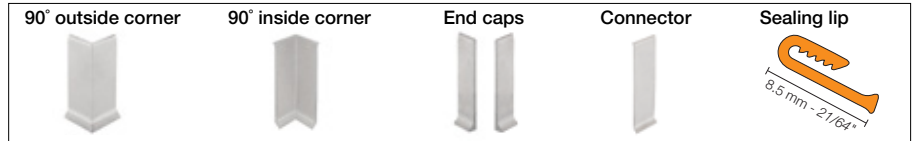
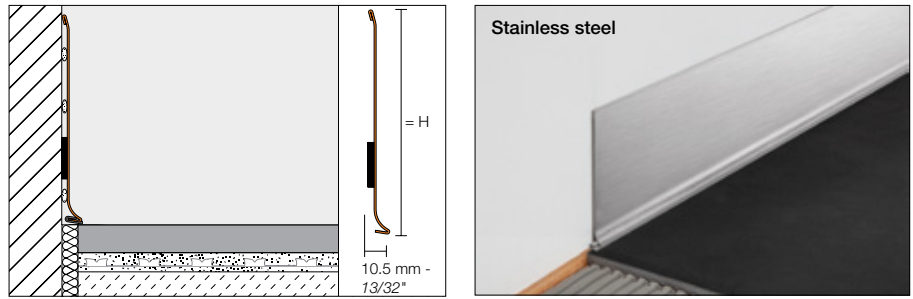

Schluter®-DESIGNBASE-SL-E

Length = 2.5 m - 8' 2-1/2"	Brushed stainless steel 304 (1.4301 = V2A) (EB)					
H = mm - in.	Profile	\$ / Length	Outside corner, 90°	\$ / Unit	Inside corner, 90°	\$ / Unit
110 - 4-3/8	DB SL 110 EB	122.67	E90 / DB SL 110 EB	61.10	I90 / DB SL 110 EB	61.10
160 - 6-3/8	DB SL 160 EB	171.98	E90 / DB SL 160 EB	63.19	I90 / DB SL 160 EB	63.19

H = mm - in.	End cap (left)	\$ / Unit	End cap (right)	\$ / Unit	Connector	\$ / Unit
110 - 4-3/8	EL / DB SL 110 EB	61.10	ER / DB SL 110 EB	61.10	V / DB SL 110 EB	33.22
160 - 6-3/8	EL / DB SL 160 EB	63.19	ER / DB SL 160 EB	63.19	V / DB SL 160 EB	34.32

Length = 2.5 m - 8' 2-1/2"	Schluter®-DESIGNBASE-SLZ-E	
	Sealing lip	\$ / Length
	DB ZS LL E	18.81

Schluter®-DESIGNBASE-SL

Length = 2.5 m - 8' 2-1/2"	Satin anodized aluminum (AE)					
H = mm - in.	Profile	\$ / Length	Outside corner, 90°	\$ / Unit	Inside corner, 90°	\$ / Unit
60 - 2-3/8	DB SL 60 AE	29.20	ED / DB SL 60 AE	10.68	ID / DB SL 60 AE	10.68
80 - 3-1/8	DB SL 80 AE	35.69	ED / DB SL 80 AE	10.68	ID / DB SL 80 AE	10.68

H = mm - in.	End cap (left)	\$ / Unit	End cap (right)	\$ / Unit	Connector	\$ / Unit
60 - 2-3/8	EL / DB SL 60 AE	9.38	ER / DB SL 60 AE	9.38	V / DB SL 60 AE	9.38
80 - 3-1/8	EL / DB SL 80 AE	9.38	ER / DB SL 80 AE	9.38	V / DB SL 80 AE	9.38



Schluter®-DESIGNBASE-SL

Length = 2.5 m - 8' 2-1/2"	Anodized aluminum with brushed stainless steel appearance (AEEB)					
-------------------------------	--	--	--	--	--	--

H = mm - in.	Profile	\$ / Length	Outside corner, 90°	\$ / Unit	Inside corner, 90°	\$ / Unit
60 - 2-3/8	DB SL 60 AEEB	90.30	ED / DB SL 60 AEEB	10.68	ID / DB SL 60 AEEB	10.68
80 - 3-1/8	DB SL 80 AEEB	118.44	ED / DB SL 80 AEEB	10.68	ID / DB SL 80 AEEB	10.68

H = mm - in.	End cap (left)	\$ / Unit	End cap (right)	\$ / Unit	Connector	\$ / Unit
60 - 2-3/8	EL / DB SL 60 AEEB	9.38	ER / DB SL 60 AEEB	9.38	V / DB SL 60 AEEB	9.38
80 - 3-1/8	EL / DB SL 80 AEEB	9.38	ER / DB SL 80 AEEB	9.38	V / DB SL 80 AEEB	9.38

Note: For reasons associated with production technology, inside corners ID / DB SL 60 AEEB and ID / DB SL 80 AEEB are not brushed.

Length = 2.5 m - 8' 2-1/2"	Matte white color-coated aluminum (MBW)					
-------------------------------	---	--	--	--	--	--

H = mm - in.	Profile	\$ / Length	Outside corner, 90°	\$ / Unit	Inside corner, 90°	\$ / Unit
60 - 2-3/8	DB SL 60 MBW	50.16	ED / DB SL 60 MBW	10.68	ID / DB SL 60 MBW	10.68
80 - 3-1/8	DB SL 80 MBW	71.19	ED / DB SL 80 MBW	10.68	ID / DB SL 80 MBW	10.68

H = mm - in.	End cap (left)	\$ / Unit	End cap (right)	\$ / Unit	Connector	\$ / Unit
60 - 2-3/8	EL / DB SL 60 MBW	9.38	ER / DB SL 60 MBW	9.38	V / DB SL 60 MBW	9.38
80 - 3-1/8	EL / DB SL 80 MBW	9.38	ER / DB SL 80 MBW	9.38	V / DB SL 80 MBW	9.38

Length = 2.5 m - 8' 2-1/2"	Schluter®-DESIGNBASE-SLZ	
-------------------------------	---------------------------------	--

Sealing lip	\$ / Length
DB ZS LL	10.68

Schluter®-REMA

Schluter®-REMA is a system for creating concealed access panels in tiled walls without impairing the visual appearance of the tile covering. REMA is suited for all tile sizes and thicknesses, and adapts perfectly to the joint pattern.

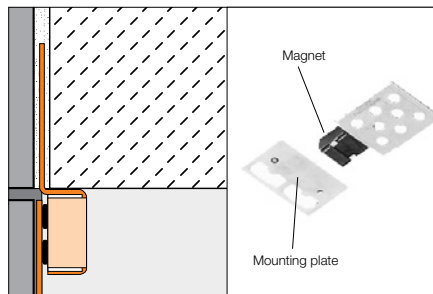

Schluter®-REMA	
Set = 4 Magnets + 4 Mounting plates	
Item No.	\$ / Set
REMA	11.61



Schluter® Profiles

Edge-protection & slip-resistant profiles for stairs

Tiled stair edges are vulnerable to chipping and breaking and create a slip hazard, especially in exterior applications. Schluter stair-nosing profiles protect exposed tile edges and improve safety on tiled stairways by providing slip-resistant wear surfaces and increased visibility—all while providing decorative accents within the tile covering.

Stair-nosing profiles are available in a variety of shapes, sizes, materials, and finishes, with options designed for both commercial and residential applications.





Schluter®-RONDEC-STEP

Schluter®-RONDEC-STEP is a finishing and edging profile for ceramic tile and dimension stone installations on countertops and stairs. The top of the profile features a symmetrically rounded edge that matches the Schluter®-RONDEC profile, while the vertical leg of the profile hides the exposed edge of the sub-assembly. RONDEC-STEP features an integrated joint spacer that establishes a defined joint cavity between the tile and the profile.

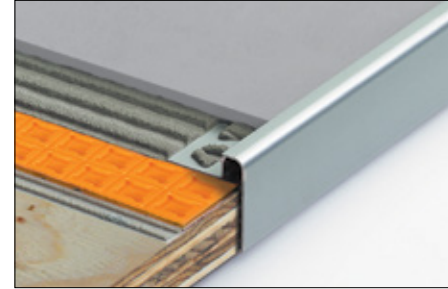
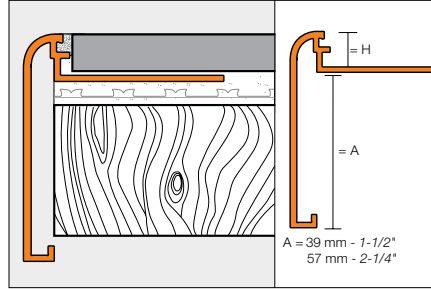

Outside corner (90° or 135°)

Inside corner (90° or 135°)

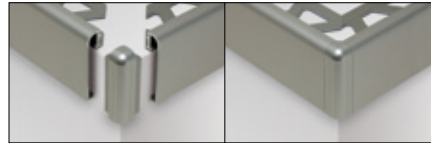

Schluter®-RONDEC-STEP

Length = 2.5 m - 8' 2-1/2"		Satin anodized aluminum (AE)						
H = mm - in.	Profile	\$ / Length	Outside corner, 90°	Outside corner, 135°	Inside corner, 90°	Inside corner, 135°	\$ / Unit	
A: 39 mm - 1-1/2"								
8 - 5/16	RS 80 AE 39	48.12	E90 RS 80 AE 39	E135 RS 80 AE 39	I90 RS 80 AE 39	I135 RS 80 AE 39	22.45	
10 - 3/8	RS 100 AE 39	48.91	E90 RS 100 AE 39	E135 RS 100 AE 39	I90 RS 100 AE 39	I135 RS 100 AE 39	22.45	
12.5 - 1/2	RS 125 AE 39	50.57	E90 RS 125 AE 39	E135 RS 125 AE 39	I90 RS 125 AE 39	I135 RS 125 AE 39	22.45	
A: 57 mm - 2-1/4"								
8 - 5/16	RS 80 AE 57	49.37	E90 RS 80 AE 57	E135 RS 80 AE 57	I90 RS 80 AE 57	I135 RS 80 AE 57	22.45	
10 - 3/8	RS 100 AE 57	50.16	E90 RS 100 AE 57	E135 RS 100 AE 57	I90 RS 100 AE 57	I135 RS 100 AE 57	22.45	
12.5 - 1/2	RS 125 AE 57	52.49	E90 RS 125 AE 57	E135 RS 125 AE 57	I90 RS 125 AE 57	I135 RS 125 AE 57	22.45	

Length = 2.5 m - 8' 2-1/2"		Brushed chrome anod. alu. (ACGB)						
H = mm - in.	Profile	\$ / Length	Outside corner, 90°	Outside corner, 135°	Inside corner, 90°	Inside corner, 135°	\$ / Unit	
A: 39 mm - 1-1/2"								
8 - 5/16	RS 80 ACGB 39	63.01	E90 RS 80 ACGB 39	E135 RS 80 ACGB 39	I90 RS 80 ACGB 39	I135 RS 80 ACGB 39	25.35	
10 - 3/8	RS 100 ACGB 39	63.71	E90 RS 100 ACGB 39	E135 RS 100 ACGB 39	I90 RS 100 ACGB 39	I135 RS 100 ACGB 39	25.35	
12.5 - 1/2	RS 125 ACGB 39	65.90	E90 RS 125 ACGB 39	E135 RS 125 ACGB 39	I90 RS 125 ACGB 39	I135 RS 125 ACGB 39	25.35	
A: 57 mm - 2-1/4"								
8 - 5/16	RS 80 ACGB 57	64.17	E90 RS 80 ACGB 57	E135 RS 80 ACGB 57	I90 RS 80 ACGB 57	I135 RS 80 ACGB 57	25.35	
10 - 3/8	RS 100 ACGB 57	64.89	E90 RS 100 ACGB 57	E135 RS 100 ACGB 57	I90 RS 100 ACGB 57	I135 RS 100 ACGB 57	25.35	
12.5 - 1/2	RS 125 ACGB 57	67.05	E90 RS 125 ACGB 57	E135 RS 125 ACGB 57	I90 RS 125 ACGB 57	I135 RS 125 ACGB 57	25.35	

Length = 2.5 m - 8' 2-1/2"		Satin nickel anod. alu. (AT)						
H = mm - in.	Profile	\$ / Length	Outside corner, 90°	Outside corner, 135°	Inside corner, 90°	Inside corner, 135°	\$ / Unit	
A: 39 mm - 1-1/2"								
8 - 5/16	RS 80 AT 39	48.12	E90 RS 80 AT 39	E135 RS 80 AT 39	I90 RS 80 AT 39	I135 RS 80 AT 39	22.45	
10 - 3/8	RS 100 AT 39	48.91	E90 RS 100 AT 39	E135 RS 100 AT 39	I90 RS 100 AT 39	I135 RS 100 AT 39	22.45	
12.5 - 1/2	RS 125 AT 39	50.57	E90 RS 125 AT 39	E135 RS 125 AT 39	I90 RS 125 AT 39	I135 RS 125 AT 39	22.45	
A: 57 mm - 2-1/4"								
8 - 5/16	RS 80 AT 57	49.37	E90 RS 80 AT 57	E135 RS 80 AT 57	I90 RS 80 AT 57	I135 RS 80 AT 57	22.45	
10 - 3/8	RS 100 AT 57	50.16	E90 RS 100 AT 57	E135 RS 100 AT 57	I90 RS 100 AT 57	I135 RS 100 AT 57	22.45	
12.5 - 1/2	RS 125 AT 57	52.49	E90 RS 125 AT 57	E135 RS 125 AT 57	I90 RS 125 AT 57	I135 RS 125 AT 57	22.45	

Length = 2.5 m - 8' 2-1/2"		Brushed nickel anod. alu. (ATGB)						
H = mm - in.	Profile	\$ / Length	Outside corner, 90°	Outside corner, 135°	Inside corner, 90°	Inside corner, 135°	\$ / Unit	
A: 39 mm - 1-1/2"								
8 - 5/16	RS 80 ATGB 39	63.01	E90 RS 80 ATGB 39	E135 RS 80 ATGB 39	I90 RS 80 ATGB 39	I135 RS 80 ATGB 39	25.35	
10 - 3/8	RS 100 ATGB 39	63.71	E90 RS 100 ATGB 39	E135 RS 100 ATGB 39	I90 RS 100 ATGB 39	I135 RS 100 ATGB 39	25.35	
12.5 - 1/2	RS 125 ATGB 39	65.90	E90 RS 125 ATGB 39	E135 RS 125 ATGB 39	I90 RS 125 ATGB 39	I135 RS 125 ATGB 39	25.35	



Schluter®-RONDEC-STEP							
Length = 2.5 m - 8' 2-1/2"	Satin copper anod. alu. (AK)						
H = mm - in.	Profile	\$/ Length	Outside corner, 90°	Outside corner, 135°	Inside corner, 90°	Inside corner, 135°	\$/ Unit
A: 39 mm - 1-1/2"							
8 - 5/16	RS 80 AK 39	48.12	E90 RS 80 AK 39	E135 RS 80 AK 39	I90 RS 80 AK 39	I135 RS 80 AK 39	22.45
10 - 3/8	RS 100 AK 39	48.91	E90 RS 100 AK 39	E135 RS 100 AK 39	I90 RS 100 AK 39	I135 RS 100 AK 39	22.45
12.5 - 1/2	RS 125 AK 39	50.57	E90 RS 125 AK 39	E135 RS 125 AK 39	I90 RS 125 AK 39	I135 RS 125 AK 39	22.45
A: 57 mm - 2-1/4"							
8 - 5/16	RS 80 AK 57	49.37	E90 RS 80 AK 57	E135 RS 80 AK 57	I90 RS 80 AK 57	I135 RS 80 AK 57	22.45
10 - 3/8	RS 100 AK 57	50.16	E90 RS 100 AK 57	E135 RS 100 AK 57	I90 RS 100 AK 57	I135 RS 100 AK 57	22.45
12.5 - 1/2	RS 125 AK 57	52.49	E90 RS 125 AK 57	E135 RS 125 AK 57	I90 RS 125 AK 57	I135 RS 125 AK 57	22.45

Length = 2.5 m - 8' 2-1/2"	Brushed copper anod. alu. (AKGB)						
H = mm - in.	Profile	\$/ Length	Outside corner, 90°	Outside corner, 135°	Inside corner, 90°	Inside corner, 135°	\$/ Unit
A: 39 mm - 1-1/2"							
8 - 5/16	RS 80 AKGB 39	63.01	E90 RS 80 AKGB 39	E135 RS 80 AKGB 39	I90 RS 80 AKGB 39	I135 RS 80 AKGB 39	25.35
10 - 3/8	RS 100 AKGB 39	63.71	E90 RS 100 AKGB 39	E135 RS 100 AKGB 39	I90 RS 100 AKGB 39	I135 RS 100 AKGB 39	25.35
12.5 - 1/2	RS 125 AKGB 39	65.90	E90 RS 125 AKGB 39	E135 RS 125 AKGB 39	I90 RS 125 AKGB 39	I135 RS 125 AKGB 39	25.35
A: 57 mm - 2-1/4"							
8 - 5/16	RS 80 AKGB 57	64.17	E90 RS 80 AKGB 57	E135 RS 80 AKGB 57	I90 RS 80 AKGB 57	I135 RS 80 AKGB 57	25.35
10 - 3/8	RS 100 AKGB 57	64.89	E90 RS 100 AKGB 57	E135 RS 100 AKGB 57	I90 RS 100 AKGB 57	I135 RS 100 AKGB 57	25.35
12.5 - 1/2	RS 125 AKGB 57	67.05	E90 RS 125 AKGB 57	E135 RS 125 AKGB 57	I90 RS 125 AKGB 57	I135 RS 125 AKGB 57	25.35

Length = 2.5 m - 8' 2-1/2"	Satin brass anod. alu. (AM)						
H = mm - in.	Profile	\$/ Length	Outside corner, 90°	Outside corner, 135°	Inside corner, 90°	Inside corner, 135°	\$/ Unit
A: 57 mm - 2-1/4"							
8 - 5/16	RS 80 AM 57	49.37	E90 RS 80 AM 57	E135 RS 80 AM 57	I90 RS 80 AM 57	I135 RS 80 AM 57	22.45
10 - 3/8	RS 100 AM 57	50.16	E90 RS 100 AM 57	E135 RS 100 AM 57	I90 RS 100 AM 57	I135 RS 100 AM 57	22.45
12.5 - 1/2	RS 125 AM 57	52.49	E90 RS 125 AM 57	E135 RS 125 AM 57	I90 RS 125 AM 57	I135 RS 125 AM 57	22.45

Length = 2.5 m - 8' 2-1/2"	Brushed brass anod. alu. (AMGB)						
H = mm - in.	Profile	\$/ Length	Outside corner, 90°	Outside corner, 135°	Inside corner, 90°	Inside corner, 135°	\$/ Unit
A: 39 mm - 1-1/2"							
8 - 5/16	RS 80 AMGB 39	63.01	E90 RS 80 AMGB 39	E135 RS 80 AMGB 39	I90 RS 80 AMGB 39	I135 RS 80 AMGB 39	25.35
10 - 3/8	RS 100 AMGB 39	63.71	E90 RS 100 AMGB 39	E135 RS 100 AMGB 39	I90 RS 100 AMGB 39	I135 RS 100 AMGB 39	25.35
12.5 - 1/2	RS 125 AMGB 39	65.90	E90 RS 125 AMGB 39	E135 RS 125 AMGB 39	I90 RS 125 AMGB 39	I135 RS 125 AMGB 39	25.35
A: 57 mm - 2-1/4"							
8 - 5/16	RS 80 AMGB 57	64.17	E90 RS 80 AMGB 57	E135 RS 80 AMGB 57	I90 RS 80 AMGB 57	I135 RS 80 AMGB 57	25.35
10 - 3/8	RS 100 AMGB 57	64.89	E90 RS 100 AMGB 57	E135 RS 100 AMGB 57	I90 RS 100 AMGB 57	I135 RS 100 AMGB 57	25.35
12.5 - 1/2	RS 125 AMGB 57	67.05	E90 RS 125 AMGB 57	E135 RS 125 AMGB 57	I90 RS 125 AMGB 57	I135 RS 125 AMGB 57	25.35

Length = 2.5 m - 8' 2-1/2"	Brushed antique bronze anod. alu. (ABGB)						
H = mm - in.	Profile	\$/ Length	Outside corner, 90°	Outside corner, 135°	Inside corner, 90°	Inside corner, 135°	\$/ Unit
A: 39 mm - 1-1/2"							
8 - 5/16	RS 80 ABGB 39	63.01	E90 RS 80 ABGB 39	E135 RS 80 ABGB 39	I90 RS 80 ABGB 39	I135 RS 80 ABGB 39	25.35
10 - 3/8	RS 100 ABGB 39	63.71	E90 RS 100 ABGB 39	E135 RS 100 ABGB 39	I90 RS 100 ABGB 39	I135 RS 100 ABGB 39	25.35
12.5 - 1/2	RS 125 ABGB 39	65.90	E90 RS 125 ABGB 39	E135 RS 125 ABGB 39	I90 RS 125 ABGB 39	I135 RS 125 ABGB 39	25.35



Schluter®-SCHIENE-STEP

Schluter®-SCHIENE-STEP is a finishing and edging profile for ceramic tile and natural stone installations on countertops, stairs, and tile over tile applications on walls. The top of the profile features a vertical wall section that finishes and protects the tile from damage, while the vertical leg covers the edge of the sub-assembly, top of the riser, or existing wall tile edge.

SCHIENE-STEP is available in anodized aluminum and brushed stainless steel versions, which have different shapes and intended uses. The stainless steel version is available in three vertical leg lengths: 1-1/2" (39 mm), 1-3/16" (30 mm), and 7/16" (11 mm). The anodized aluminum version is intended for residential stair applications (stairs not exposed to heavy traffic). It is available in two vertical leg lengths, 1-3/16" (30 mm) and 1-1/2" (39 mm). The ribbed vertical leg covers the sub-assembly or top of the riser. The integrated joint spacer establishes a defined joint cavity between the tile and the profile.

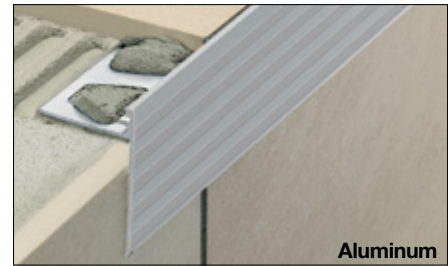
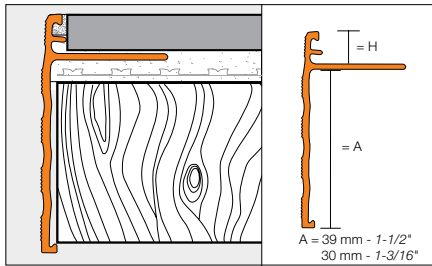
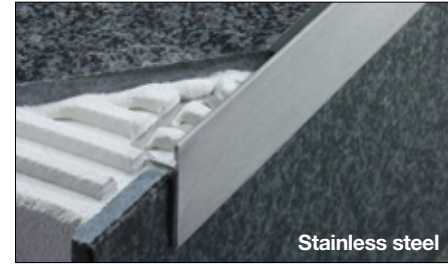
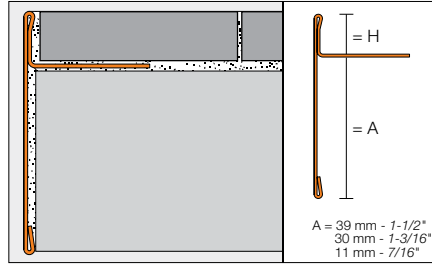

Schluter®-SCHIENE-STEP							
Length = 2.5 m - 8' 2-1/2"	Brushed Stainless Steel 304 (1.4301 = V2A) (EB)						
H = mm - in.	Profile	\$/ Length	Inside corner, 90°	Inside corner, 135°	Outside corner, 90° and End Cap	Outside corner, 135°	\$/ Unit
A: 39 mm - 1-1/2"							
6 - 1/4	SS 60 EB 39	145.96	I90 / SS 60 EB 39	I135 / SS 60 EB 39	E90 / SS 60 EB 39	E135 / SS 60 EB 39	19.28
9 - 11/32	SS 90 EB 39	152.02	I90 / SS 90 EB 39	I135 / SS 90 EB 39	E90 / SS 90 EB 39	E135 / SS 90 EB 39	19.28
11 - 7/16	SS 110 EB 39	154.76	I90 / SS 110 EB 39	I135 / SS 110 EB 39	E90 / SS 110 EB 39	E135 / SS 110 EB 39	19.28
12.5 - 1/2	SS 125 EB 39	157.20	I90 / SS 125 EB 39	I135 / SS 125 EB 39	E90 / SS 125 EB 39	E135 / SS 125 EB 39	19.28
A: 30 mm - 1-3/16"							
9 - 11/32	SS 90 EB 30	114.94	-	-	E90 / SS 90 EB 30	-	19.28
11 - 7/16	SS 110 EB 30	116.41	-	-	E90 / SS 110 EB 30	-	19.28
12.5 - 1/2	SS 125 EB 30	117.89	-	-	E90 / SS 125 EB 30	-	19.28
A: 11 mm - 7/16"							
6 - 1/4	SS 60 EB 11	110.58					
12.5 - 1/2	SS 125 EB 11	112.01					

Brushed Stainless Steel 304 (1.4301 = V2A) (EB)		
H = mm - in.	Connector	\$/ Unit
A: 39 mm - 1-1/2"		
6 - 1/4	V / SS 60 EB 39	16.39
9 - 11/32	V / SS 90 EB 39	16.39
11 - 7/16	V / SS 110 EB 39	16.39
12.5 - 1/2	V / SS 125 EB 39	16.39
A: 30 mm - 1-3/16"		
9 - 11/32	V / SS 90 EB 30	16.39
11 - 7/16	V / SS 110 EB 30	16.39
12.5 - 1/2	V / SS 125 EB 30	16.39
A: 11 mm - 7/16"		
6 - 1/4	V / SS 60 EB 11	16.39
12.5 - 1/2	V / SS 125 EB 11	16.39

Schluter®-SCHIENE-STEP				
Length = 2.5 m - 8' 2-1/2"	Satin anodized aluminum (AE)		Satin nickel anodized aluminum (AT)	
H = mm - in.	Profile	\$/ Length	Profile	\$/ Length
A: 30 mm - 1-3/16"				
8 - 5/16	SS 80 AE 30	40.07	SS 80 AT 30	44.21
10 - 3/8	SS 100 AE 30	40.70	SS 100 AT 30	44.67
12.5 - 1/2	SS 125 AE 30	41.44	SS 125 AT 30	45.41
15 - 9/16	SS 150 AE 30	42.08	SS 150 AT 30	46.03
A: 39 mm - 1-1/2"				
8 - 5/16	SS 80 AE 39	43.57	SS 80 AT 39	47.53
10 - 3/8	SS 100 AE 39	44.28	SS 100 AT 39	48.23
12.5 - 1/2	SS 125 AE 39	44.89	SS 125 AT 39	48.87
15 - 9/16	SS 150 AE 39	45.59	SS 150 AT 39	49.54

Note: The anchoring leg of Schluter®-SCHIENE-STEP is available with a special radius perforation so that the profile can be used to form curves.

- Available in stainless steel only
- Price surcharge: \$0.70 per foot
- Item No.: R / Profile No. (e.g., R/SS 60 EB 11)
- For delivery time, please call Customer Service





Schluter®-TREP-FL

Schluter®-TREP-FL is a decorative stair-nosing profile with a protruding rounded edge that can be integrated into stairs covered with tile or stone. The profile protects the front edge of stairs and adds a high degree of safety by improving the visibility of the stair edges. The profile is available in stainless steel or anodized aluminum. TREP-FL is suitable for residential applications, e.g., stairs not exposed to heavy traffic.

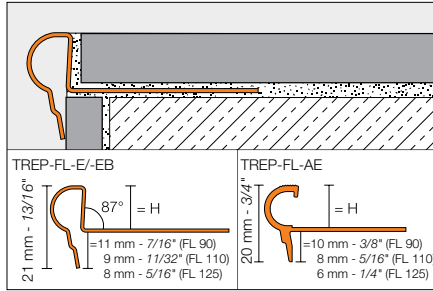

End cap (E/)



Schluter®-TREP-FL		
Stainless steel 304 (1.4301 = V2A) (E)		
H = mm - in.	Item No.	\$ / Length
Length = 2.5 m - 8' 2-1/2"		
9 - 11/32	FL 90 E	67.92
11 - 7/16	FL 110 E	70.90
12.5 - 1/2	FL 125 E	74.05
Length = 1.50 m - 4' 11"		
9 - 11/32	FL 90 E/150	40.74
11 - 7/16	FL 110 E/150	42.53
12.5 - 1/2	FL 125 E/150	44.43
End cap		\$ / Unit
E/FLEB		4.85

Schluter®-TREP-FL		
Brushed stainless steel 304 (1.4301 = V2A) (EB)		
H = mm - in.	Item No.	\$ / Length
Length = 2.5 m - 8' 2-1/2"		
9 - 11/32	FL 90 EB	81.52
11 - 7/16	FL 110 EB	85.09
12.5 - 1/2	FL 125 EB	88.85
Length = 1.50 m - 4' 11"		
9 - 11/32	FL 90 EB/150	48.92
11 - 7/16	FL 110 EB/150	51.03
12.5 - 1/2	FL 125 EB/150	53.33
End cap		\$ / Unit
E/FLEB		4.85

Schluter®-TREP-FL		
Satin anodized aluminum (AE)		
H = mm - in.	Item No.	\$ / Length
Length = 2.5 m - 8' 2-1/2"		
9 - 11/32	FL 90 AE	31.07
11 - 7/16	FL 110 AE	31.72
12.5 - 1/2	FL 125 AE	32.35
Length = 1.50 m - 4' 11"		
9 - 11/32	FL 90 AE/150	22.01
11 - 7/16	FL 110 AE/150	22.41
12.5 - 1/2	FL 125 AE/150	24.08
End cap		\$ / Unit
E/FLAE		1.96



Schluter®-TREP-E

Schluter®-TREP-E is designed to protect tiled stair edges and provide an easily visible, slip-resistant wear surface for durable, safe, and visually appealing stair-nosing design. The profile is made of stainless steel with an integrated slip-resistant tread, making it suitable for interior and exterior use in areas subjected to heavy foot-traffic, such as offices or public buildings. TREP-E features a trapezoid-perforated anchoring leg that is secured in the bond coat beneath the tile.

Note: Sizes 80, 110, and 160 are also available in stainless steel 316L (1.4404 = V4A). Contact Customer Service for pricing and availability.



A version without the anchoring leg for retrofit applications is also available. Please refer to TREP-EK on page 71.

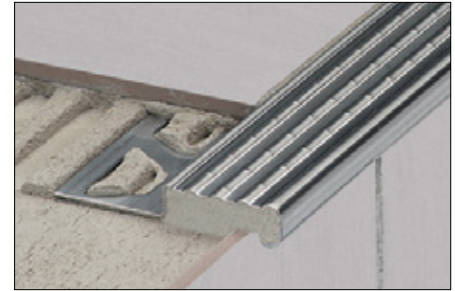
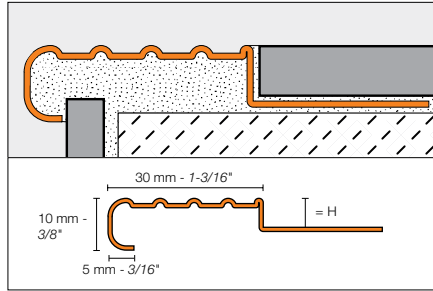

Schluter®-TREP-E		
Stainless steel 304 (1.4301 = V2A) (E)		
H = mm - in.	Item No.	\$ / Length
Length = 2.5 m - 8' 2-1/2"		
2 - 3/32	TE 20	50.07
5 - 3/16	TE 50	51.77
8 - 5/16	TE 80	53.31
11 - 7/16	TE 110	54.88
16 - 5/8	TE 160	57.52
25 - 1	TE 250	61.79
Length = 1.50 m - 4' 11"		
2 - 3/32	TE 20/150	31.32
5 - 3/16	TE 50/150	32.35
8 - 5/16	TE 80/150	33.33
11 - 7/16	TE 110/150	34.27
16 - 5/8	TE 160/150	35.98
25 - 1	TE 250/150	39.05
End cap		\$ / Unit
E/TE		3.18

End cap (E/)



TREP-E



Schluter®-TREP-G

Schluter®-TREP-G is designed to protect tiled stair edges and provide an easily visible, slip-resistant wear surface for durable, safe, and visually appealing stair-nosing design. The profile is made of stainless steel, making it suitable for interior and exterior use in areas subjected to heavy foot-traffic, such as offices or public buildings. The surface features a self-adhesive, non-slip tread with an embedded mineral grain coating, which can be replaced in case of damage or wear. TREP-G features a trapezoid-perforated anchoring leg that is secured in the bond coat beneath the tile.

Note: Sizes 130 and 150 are not stocked. Please call Customer Service for delivery times.



A version without the anchoring leg for retrofit applications is also available. Please refer to TREP-GK on page 72.

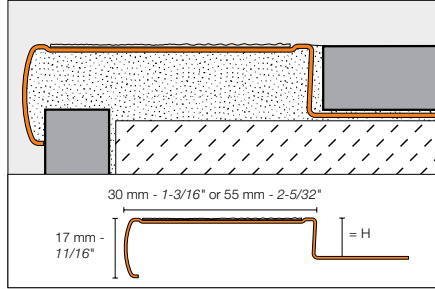

Schluter®-TREP-G-S		
Brushed stainless steel support with non-slip tread (30 mm - 1-3/16")		
H = mm - in.	Item No.	\$ / Length
Length = 2.5 m - 8' 2-1/2"		
9 - 11/32	GS EB 90 + color*	140.92
11 - 7/16	GS EB 110 + color*	142.45
13 - 33/64	GS EB 130 + color*	143.94
15 - 9/16	GS EB 150 + color*	146.41
Length = 1.50 m - 4' 11"		
9 - 11/32	GS EB 90 + color*/150	89.26
11 - 7/16	GS EB 110 + color*/150	90.24
13 - 33/64	GS EB 130 + color*/150	91.17
15 - 9/16	GS EB 150 + color*/150	92.55
Replacement tread		
Length = 18.3 m - 60' 1/32"		\$ / Unit
GS KB 183 + color*		155.32
End cap		\$ / Unit
E/GS EB		4.79

Schluter®-TREP-G-B		
Brushed stainless steel support with non-slip tread (55 mm - 2-5/32")		
H = mm - in.	Item No.	\$ / Length
Length = 2.5 m - 8' 2-1/2"		
9 - 11/32	GB EB 90 + color*	180.82
11 - 7/16	GB EB 110 + color*	182.08
13 - 33/64	GB EB 130 + color*	183.60
15 - 9/16	GB EB 150 + color*	185.11
Length = 1.50 m - 4' 11"		
9 - 11/32	GB EB 90 + color*/150	113.88
11 - 7/16	GB EB 110 + color*/150	114.70
13 - 33/64	GB EB 130 + color*/150	115.65
15 - 9/16	GB EB 150 + color*/150	116.59
Replacement tread		
Length = 18.3 m - 60' 1/32"		\$ / Unit
GB KB 183 + color*		279.90
End cap		\$ / Unit
E/GB EB		4.79

*Color Codes	
Transparent	Black
* To complete the item number, add the color code (e.g., GS EB 90 GS).	





Schluter®-TREP-V

Schluter®-TREP-V is an anodized aluminum profile with a PVC tread designed to protect tiled stair edges. The specially textured slip resistant tread makes TREP-V well suited for use in areas with heavy foot traffic, such as offices or public buildings. The replaceable PVC tread is available in a variety of colors including high visibility options. TREP-V is available with either a narrow (TREP-V 42) or wide (TREP-V 60) tread. End caps are also available.

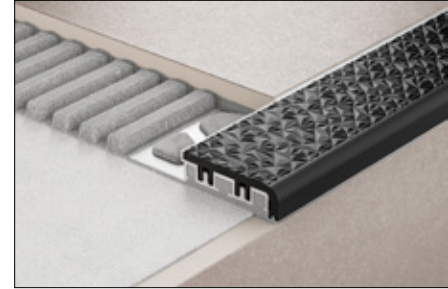
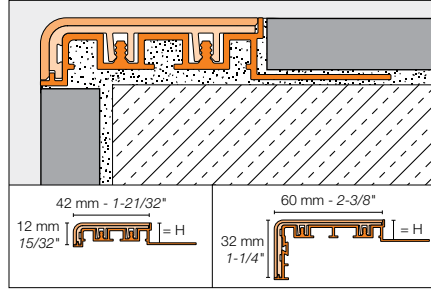

Schluter®-TREP-V 42			
Anodized aluminum support with slip-resistant PVC insert (42 mm / 12 mm - 1-21/32" / 15/32")			
H = mm - in.	Item No.		\$ / Length
Length = 1 m - 3' 3"			
9 - 11/32	TVL 42 + color*	90/100	26.55
11 - 7/16	TVL 42 + color*	110/100	28.18
12.5 - 1/2	TVL 42 + color*	125/100	29.41
Length = 1.50 m - 4' 11"			
9 - 11/32	TVL 42 + color*	90/150	40.20
11 - 7/16	TVL 42 + color*	110/150	42.66
12.5 - 1/2	TVL 42 + color*	125/150	44.51
Length = 2 m - 6' 7"			
9 - 11/32	TVL 42 + color*	90/200	53.76
11 - 7/16	TVL 42 + color*	110/200	57.05
12.5 - 1/2	TVL 42 + color*	125/200	59.53
Length = 3.05 m - 10'			
9 - 11/32	TVL 42 + color*	90/300	80.48
11 - 7/16	TVL 42 + color*	110/300	85.37
12.5 - 1/2	TVL 42 + color*	125/300	89.05
Replacement PVC insert (42 mm / 12 mm - 1-21/32" / 15/32")			
Length = 2 m - 6' 7"			
	TVL 42 + color*/200		21.44
Length = 3.05 m - 10'			
	TVL 42 + color*/300		31.95
End cap (1 right + 1 left)			\$ / Set
	E / TV 42 + color*		4.08

Schluter®-TREP-V 60			
Anodized aluminum support with slip-resistant PVC insert (60 mm / 32 mm - 2-3/8" / 1-1/4")			
H = mm - in.	Item No.		\$ / Length
Length = 1 m - 3' 3"			
9 - 11/32	TVL 60 + color*	90/100	36.83
11 - 7/16	TVL 60 + color*	110/100	39.06
12.5 - 1/2	TVL 60 + color*	125/100	40.74
Length = 1.50 m - 4' 11"			
9 - 11/32	TVL 60 + color*	90/150	55.75
11 - 7/16	TVL 60 + color*	110/150	59.12
12.5 - 1/2	TVL 60 + color*	125/150	61.68
Length = 2 m - 6' 7"			
9 - 11/32	TVL 60 + color*	90/200	74.56
11 - 7/16	TVL 60 + color*	110/200	79.06
12.5 - 1/2	TVL 60 + color*	125/200	82.49
Length = 3.05 m - 10'			
9 - 11/32	TVL 60 + color*	90/300	111.49
11 - 7/16	TVL 60 + color*	110/300	118.22
12.5 - 1/2	TVL 60 + color*	125/300	123.42
Replacement PVC insert (60 mm / 32 mm - 2-3/8" / 1-1/4")			
Length = 2 m - 6' 7"			
	TVL 60 + color*/200		29.71
Length = 3.05 m - 10'			
	TVL 60 + color*/300		44.26
End cap (1 right + 1 left)			\$ / Set
	E / TV 60 + color*		4.82

***Color Codes**

* To complete the item number, add the **color** code (e.g., TVL 42 **GS** 90/200).

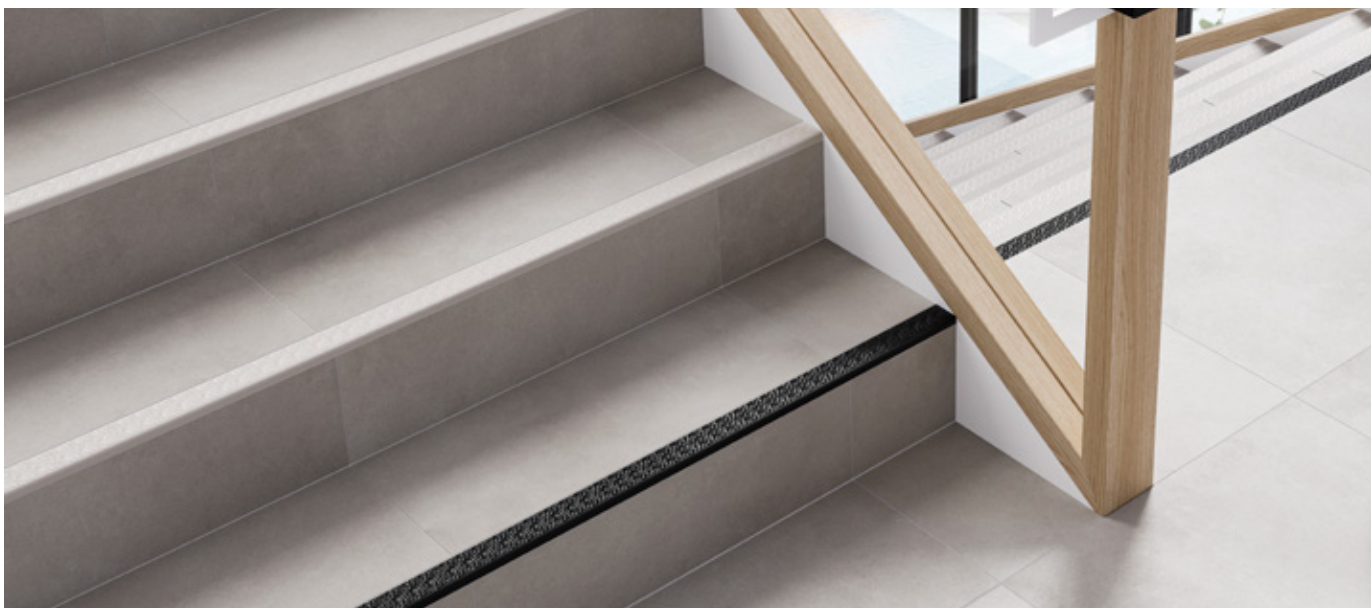
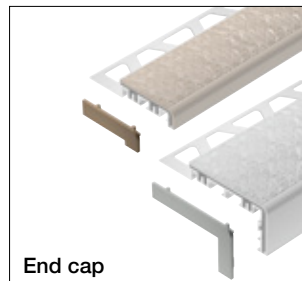
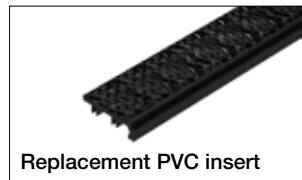



Schluter®-TREP-SE/-S/-B

Schluter®-TREP-SE/-S/-B are designed to protect tiled stair edges and provide an easily visible, slip-resistant wear surface for durable, safe, and visually appealing stair-nosing design. They are suitable for use in areas subjected to heavy foot-traffic, such as offices or public buildings. The profiles feature a trapezoid-perforated anchoring leg made of stainless steel (-SE) or aluminum (-S and -B), with a slip-resistant, thermoplastic rubber wear surface. The tread surface is available in a variety of colors and can be replaced in case of damage or wear.

Note: Radius of leading edge for TREP-S and TREP-B: 8 mm - 5/16".

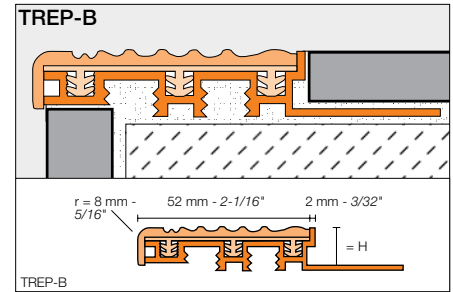
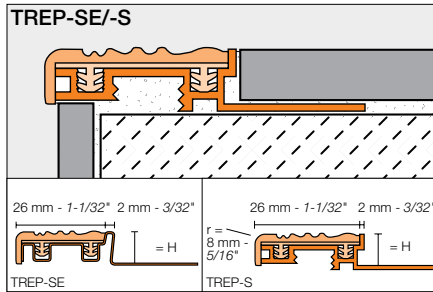
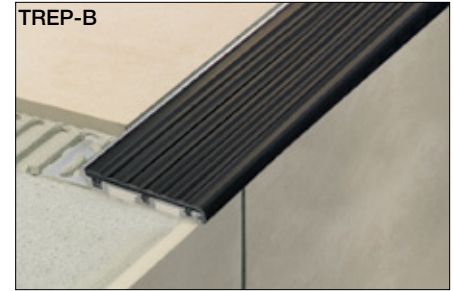
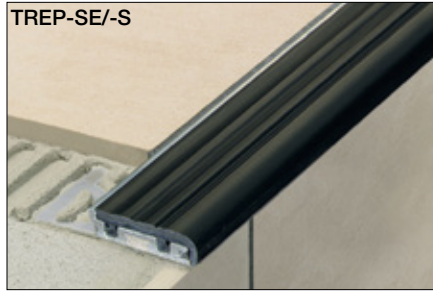

Schluter®-TREP-SE		
Stainless steel support with thermoplastic rubber insert (26 mm - 1-1/32")		
H = mm - in.	Item No.	\$ / Length
Length = 2.5 m - 8' 2-1/2"		
8 - 5/16	color* + 8 SE	79.91
10 - 3/8	color* + 10 SE	82.38
12.5 - 1/2	color* + 12 SE	85.76
Length = 1.50 m - 4' 11"		
8 - 5/16	color* + 8 SE/150	49.93
10 - 3/8	color* + 10 SE/150	51.49
12.5 - 1/2	color* + 12 SE/150	52.94
Stainless steel support section		
Length = 2.5 m - 8' 2-1/2"		
8 - 5/16	TES 8	61.03
10 - 3/8	TES 10	63.46
12.5 - 1/2	TES 12	66.88
Length = 1.50 m - 4' 11"		
8 - 5/16	TES 8/150	41.41
10 - 3/8	TES 10/150	41.88
12.5 - 1/2	TES 12/150	42.97
Replacement thermoplastic rubber insert		
Length = 2.5 m - 8' 2-1/2"		
PE 26/+ color*		18.71
Length = 3 m - 9' 10"		
PE 26/+ color*/300		23.39
End cap		\$ / Unit
E 26/+ color*		1.76

Schluter®-TREP-S		
Aluminum support with thermoplastic rubber insert (26 mm - 1-1/32")		
H = mm - in.	Item No.	\$ / Length
Length = 2.5 m - 8' 2-1/2"		
8 - 5/16	color* + 8 S	53.40
10 - 3/8	color* + 10 S	55.46
12.5 - 1/2	color* + 12 S	58.94
Length = 1.50 m - 4' 11"		
8 - 5/16	color* + 8 S/150	34.05
10 - 3/8	color* + 10 S/150	34.67
12.5 - 1/2	color* + 12 S/150	36.81
Aluminum support section		
Length = 2.5 m - 8' 2-1/2"		
8 - 5/16	TAS 8	35.24
10 - 3/8	TAS 10	37.29
12.5 - 1/2	TAS 12	40.75
Length = 1.50 m - 4' 11"		
8 - 5/16	TAS 8/150	17.65
10 - 3/8	TAS 10/150	18.65
12.5 - 1/2	TAS 12/150	20.39
Replacement thermoplastic rubber insert		
Length = 2.5 m - 8' 2-1/2"		
PEA 26/+ color*		18.71
Length = 3 m - 9' 10"		
PEA 26/+ color*/300		23.39
Length = 15 m - 50'		
PEA 26/+ color*/50		116.94
End cap		\$ / Unit
E 26/+ color*		1.76

Schluter®-TREP-B		
Aluminum support with thermoplastic rubber insert (52 mm - 2-1/16")		
H = mm - in.	Item No.	\$ / Length
Length = 2.5 m - 8' 2-1/2"		
8 - 5/16	color* + 8 B	77.52
10 - 3/8	color* + 10 B	82.24
12.5 - 1/2	color* + 12 B	85.83
15 - 9/16	color* + 15 B	90.57
25 - 1	color* + 25 B	92.61
Length = 1.50 m - 4' 11"		
8 - 5/16	color* + 8 B/150	48.46
10 - 3/8	color* + 10 B/150	51.40
12.5 - 1/2	color* + 12 B/150	53.62
15 - 9/16	color* + 15 B/150	56.60
25 - 1	color* + 25 B/150	57.91
Aluminum support section		
Length = 2.5 m - 8' 2-1/2"		
8 - 5/16	TAB 8	48.13
10 - 3/8	TAB 10	52.86
12.5 - 1/2	TAB 12	56.44
15 - 9/16	TAB 15	61.18
25 - 1	TAB 25	63.23
Length = 1.50 m - 4' 11"		
8 - 5/16	TAB 8/150	24.06
10 - 3/8	TAB 10/150	26.42
12.5 - 1/2	TAB 12/150	28.23
15 - 9/16	TAB 15/150	30.58
25 - 1	TAB 25/150	31.61
Replacement thermoplastic rubber insert		
Length = 2.5 m - 8' 2-1/2"		
PEA 52/+ color*		30.26
Length = 3 m - 9' 10"		
PEA 52/+ color*/300		37.83
Length = 15 m - 50'		
PEA 52/+ color*/50		189.26
End cap		\$ / Unit
E 52/+ color*		2.18

*Color Codes



* To complete the item number, add the color code (e.g., G 10 SE).

End cap (E26/ or E52/)

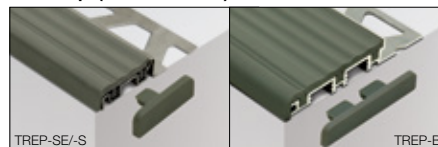



Schluter®-TREP-TAP

Schluter®-TREP-TAP is an anodized aluminum cover profile that integrates with the Schluter®-TREP-S/-B stair-nosing profiles to conceal the top of the riser. There are two options available: a 2-13/32" (61 mm) version featuring horizontal grooves, and a 2" (50 mm) version with a smooth surface finish.

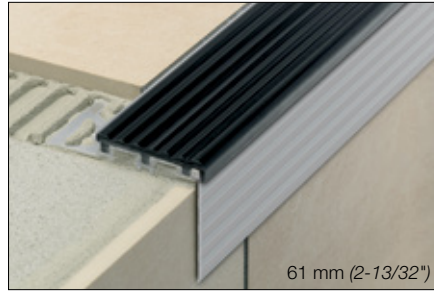

61 mm (2-13/32")

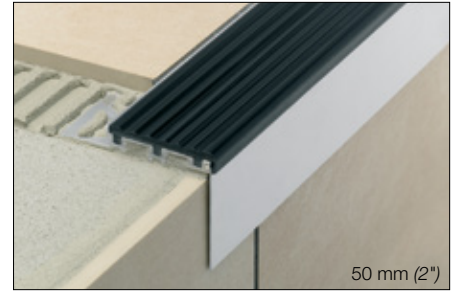

50 mm (2")

Schluter®-TREP-TAP	
Satin anodized aluminum (AE)	
Item No.	\$ / Length
50 mm - 2" Smooth	
Length = 2.5 m - 8' 2-1/2"	
TAP 50 AE	34.96
Length = 1.50 m - 4' 11"	
TAP 50 AE/150	22.01
Length = 1.00 m - 3' 3"	
TAP 50 AE/100	16.19
61 mm - 2-13/32" Grooved	
Length = 2.5 m - 8' 2-1/2"	
TAPR 61 AE	35.94
Length = 1.50 m - 4' 11"	
TAPR 61 AE/150	21.93

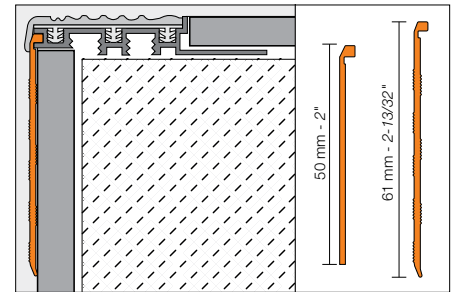

TREP-E (page 66)

Safety can be retrofitted

The installation of stair nosing profiles is not always a consideration during the initial construction of stairs. Schluter®-TREP profiles are also available for retrofit installation to help you enhance the safety of stairs at a later point. Schluter®-KERDI-FIX ensures the secure installation of these profiles:

- Schluter®-TREP-EK with slip-resistant wear surface
- Schluter®-TREP-EFK for bonding in milled grooves
- Schluter®-TREP-GK with replaceable, self-adhesive non-slip tread



TREP-GK (page 72)

Schluter®-TREP-EK

Schluter®-TREP-EK is designed to protect tiled stair edges and provide an easily visible, slip-resistant wear surface for durable, safe, and visually appealing stair-nosing design. The profile is made of stainless steel with an integrated slip-resistant wear surface, making it suitable for interior and exterior use in areas subjected to heavy foot-traffic, such as offices or public buildings.

TREP-EK is subsequently bonded to existing installations. As such, TREP-EK can be installed as a repair so that existing, damaged stair treads do not have to be replaced.

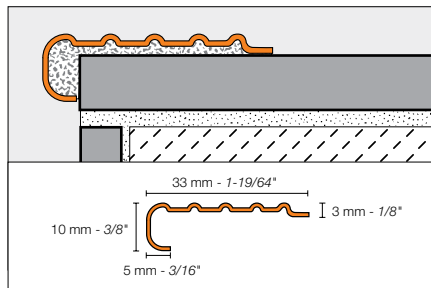

Schluter®-TREP-EK	
Stainless steel 304 (1.4301 = V2A) (E)	
Item No.	\$ / Length
Length = 2.5 m - 8' 2-1/2"	
TEK	54.87
Length = 1.50 m - 4' 11"	
TEK/150	32.92



Schluter®-TREP-EFK

Schluter®-TREP-EFK is a retrofit stainless steel stair profile which is bonded to existing steps. The stair profile features an easily visible, slip-resistant wear surface for durable and safe stairs. The profile is suitable for interior and exterior use in areas subjected to heavy foot traffic, such as offices or public buildings.

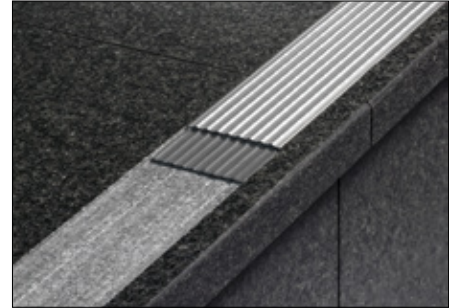
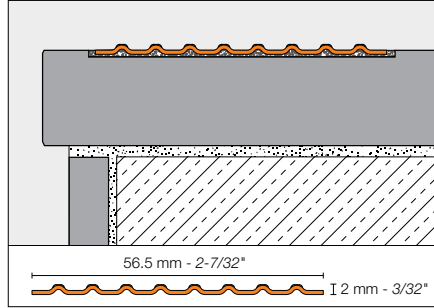

Schluter®-TREP-EFK	
Stainless steel 316L (1.4404 = V4A) (E)	
Item No.	\$ / Length
Length = 2.5 m - 8' 2-1/2"	
TEF56K/V4A	71.32

Schluter®-TREP-GK

Schluter®-TREP-GK is designed to protect tiled stair edges and provide an easily visible, slip-resistant wear surface for durable, safe, and visually appealing stair-nosing design. The profile is made of stainless steel, making it suitable for interior and exterior use in areas subjected to heavy foot-traffic, such as offices or public buildings. The surface features a self-adhesive, non-slip tread with an embedded mineral grain coating, which can be replaced in case of damage or wear.

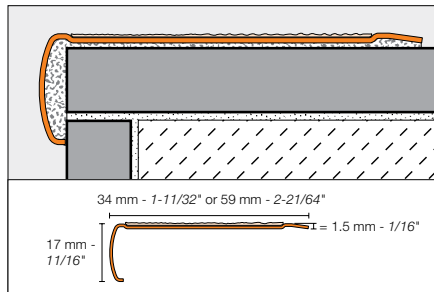

TREP-GK is subsequently bonded to existing installations. As such, TREP-GK can be installed as a repair so that existing, damaged stair treads do not have to be replaced.

Schluter®-TREP-GK-S	
Brushed stainless steel support with non-slip tread (34 mm - 1-11/32")	
Item No.	\$ / Length
Length = 2.5 m - 8' 2-1/2"	
GS EBK + color*	119.19
Length = 1.50 m - 4' 11"	
GS EBK + color*/150	75.56
Replacement tread	
Item No.	\$ / Unit
Length = 18.3 m - 60' 1/32"	
GS KB 183 + color*	155.32

Schluter®-TREP-GK-B	
Brushed stainless steel support with non-slip tread (59 mm - 2-21/64")	
Item No.	\$ / Length
Length = 2.5 m - 8' 2-1/2"	
GB EBK + color*	158.85
Length = 1.50 m - 4' 11"	
GB EBK + color*/150	100.03
Replacement tread	
Item No.	\$ / Unit
Length = 18.3 m - 60' 1/32"	
GB KB 183 + color*	279.90

***Color Codes**

Transparent

Black

* To complete the item number, add the color code (e.g., GS EBK **GS**).



Schluter® Profiles

Movement joint & cove-shaped profiles

Movement joints are an integral part of any tile assembly and must be incorporated within the tile field at doorsills, and at transitions to walls and other restraining structures to allow movement of the assembly and prevent stresses that can damage the system. Schluter movement joint profiles protect tile edges and prevent sound bridges and surface water penetration, resulting in a permanent, maintenance-free installation.

Cove bases are a practical and hygienic method for treating floor-to-wall or wall-to-wall transitions, as they provide a curved surface that is easy to clean and prevent the accumulation of dirt. Schluter cove-shaped profiles provide an attractive, clean, and maintenance-free alternative for inside wall corners and floor/wall (including countertop/backsplash) transitions. Plus, they completely eliminate the need for caulk.



Schluter®-DILEX-MOP

Schluter®-DILEX-MOP is a screed joint profile with rigid PVC side sections that protect tile edges and a soft PVC movement zone that separates individual fields in the tile assembly and forms the visible surface. DILEX-MOP is designed to provide movement joints in tile installations that are set in a mortar bed (e.g., ceramic tile, natural stone, pavers, and agglomerate tile).

Note: Available only in grey.

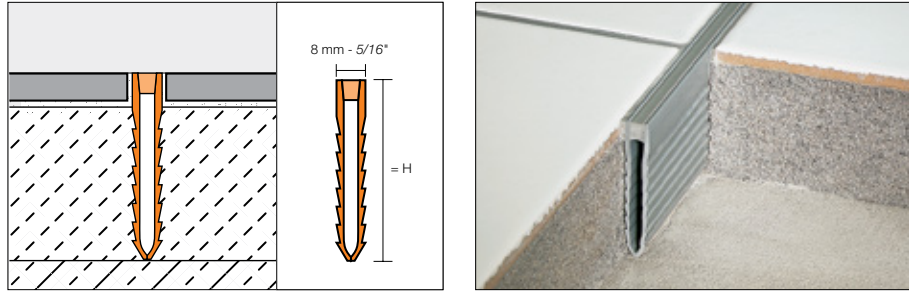

Schluter®-DILEX-MOP		
Length = 2.5 m - 8' 2-1/2"	Screed joint profile	
H = mm - in.	Item No.	\$ / Length
35 - 1-3/8	MOP 35 G	18.51
50 - 2	MOP 50 G	23.61
65 - 2-5/8	MOP 65 G	27.48

WARNING: Cancer www.P65Warnings.ca.gov

Schluter®-DILEX-MP/-MPV

Schluter®-DILEX-MP is a screed joint profile with rigid PVC side sections that protect tile edges and a soft chlorinated polyethylene (CPE) movement zone that separates individual fields in the tile assembly and forms the visible surface. The movement zone is available in different colors to match the grout. DILEX-MP is designed to provide movement joints in tile installations that are set in a mortar bed (e.g., ceramic tile, natural stone, pavers, and agglomerate tile). DILEX-MP adjusts to the thickness of the mortar bed and tile surface by attaching the DILEX-MPV extensions.

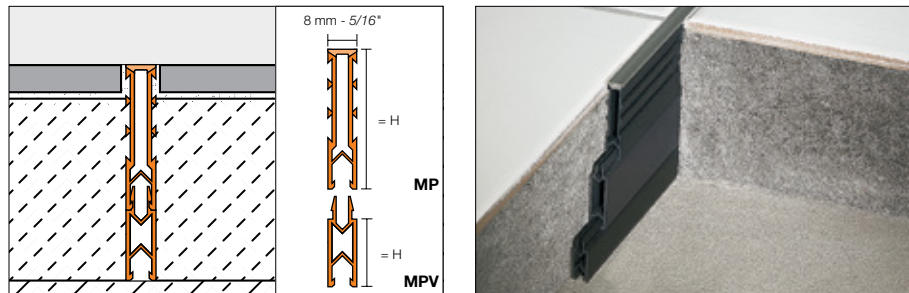

***Color Codes**



* To complete the item number, add the **color** code (e.g., MP 35 **G**).

Schluter®-DILEX-MP		
Length = 2.5 m - 8' 2-1/2"	Screed joint profile	
H = mm - in.	Item No.	\$ / Length
35 - 1-3/8	MP 35 + color *	21.79

Schluter®-DILEX-MPV		
Length = 2.5 m - 8' 2-1/2"	Extension profile	
H = mm - in.	Item No.	\$ / Length
15 - 9/16	MPV 15	14.73
25 - 1	MPV 25	15.84



Schluter®-DILEX-EZ 6 + 9

Schluter®-DILEX-EZ 6 and **9** combine decorative design with stress-relieving function for tile and stone set in a thin bed of adhesive. The profile features two usable surfaces in different colors. The sidewalls are made of rigid PVC; the movement zones are made of soft PVC.

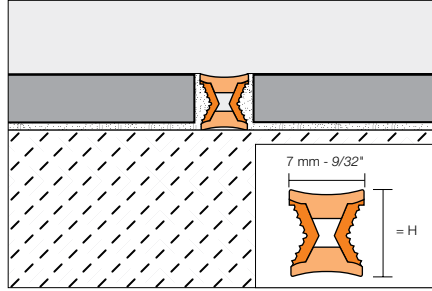

*Color Codes

- G Grey
- CG Yellow
- M/G** = Brass inlay / grey
- C/CG** = Chrome inlay / yellow

Schluter®-DILEX-EZ 6 + 9

Length = 2.5 m - 8' 2-1/2"		Decorative movement joint	
H = mm - in.		Item No.	\$/ Length
6 - 1/4		EZ M/G 6	17.70
6 - 1/4		EZ C/CG 6	17.70
9 - 11/32		EZ M/G 9	21.06
9 - 11/32		EZ C/CG 9	21.06

⚠ WARNING: Cancer and Reproductive Harm - www.P65Warnings.ca.gov

Schluter®-DILEX-BWS

Schluter®-DILEX-BWS is a surface joint profile with rigid PVC anchoring legs that protect tile edges and a 3/16" (5 mm)-wide, soft CPE movement zone that separates individual fields in the tile covering and forms the visible surface. The movement zone is available in different colors to match the grout. The profile absorbs relatively limited movements and may be installed with greater frequency to create smaller fields, or the Schluter®-DILEX-BWB (3/8" - 10 mm movement zone) may be used. DILEX-BWS is suitable for residential to medium-duty commercial applications subject to light mechanical loads (e.g., offices and stores). The profile is also suited for exterior use.

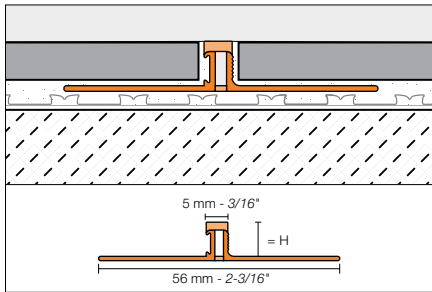

*Color Codes

- BW Bright white
- SP Sand pebble
- HB Light beige
- PG Classic grey
- G Grey
- C Cream
- SG Stone grey
- FG Grout grey
- DA Dark anthracite
- GS Black

* To complete the item number, add the **color** code (e.g., BWS 80 **G**).

Schluter®-DILEX-BWS

Length = 2.5 m - 8' 2-1/2"		PVC surface joint profile (5 mm - 3/16")	
H = mm - in.		Item No.	\$/ Length
4.5 - 3/16		BWS 45 + color*	19.38
6 - 1/4		BWS 60 + color*	19.38
8 - 5/16		BWS 80 + color*	19.38
9 - 11/32		BWS 90 + color*	20.37
10 - 3/8		BWS 100 + color*	20.37
11 - 7/16		BWS 110 + color*	20.37
12.5 - 1/2		BWS 125 + color*	20.37

Schluter®-DILEX-BWB

Schluter®-DILEX-BWB is a surface joint profile with rigid PVC anchoring legs that protect tile edges and a 3/8" (10 mm)-wide, soft CPE movement zone that separates individual fields in the tile covering and forms the visible surface. The movement zone is available in different colors to match the grout. DILEX-BWB is suitable for residential to medium-duty commercial applications subject to light mechanical loads (e.g., offices and stores). The profile is also suited for exterior use.

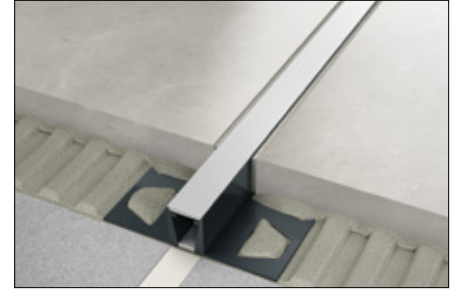
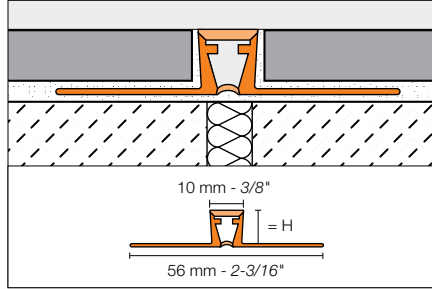

***Color Codes**

BW Bright white	SP Sand pebble	HB Light beige	PG Classic grey	G Grey
C Cream	SG Stone grey	FG Grout grey	DA Dark anthracite	GS Black

* To complete the item number, add the **color** code (e.g., BWB 80 G).
** BWB 60 is not available in sand pebble (SP).

Schluter®-DILEX-BWB		
Length = 2.5 m - 8' 2-1/2"	PVC surface joint profile (10 mm - 3/8")	
H = mm - in.	Item No.	\$ / Length
6 - 1/4	BWB 60 + color**	20.93
8 - 5/16	BWB 80 + color*	21.47
10 - 3/8	BWB 100 + color*	22.48
12.5 - 1/2	BWB 125 + color*	22.48
15 - 9/16	BWB 150 G (Grey only)	26.04
20 - 3/4	BWB 200 G (Grey only)	27.88

Schluter®-DILEX-F

Schluter®-DILEX-F is a surface joint profile with rigid, recycled PVC anchoring legs and a narrow replaceable silicone inlay that ties together tile fields to form a seamless visible surface. The carrier profile (DILEX-FCS) has a protective cover that is removed after tile installation and replaced with the selected color of silicone insert (DILEX-FIS). The trapezoid-perforated anchoring legs transfer movement to the profile movement zone. The special silicone inlay is equipped with anti-stretch properties and a low-friction coating that repels dust. The inlay is approximately 1/8" (3.5 mm) wide when installed and available in 10 colors to match the grout. The DILEX-F system is suitable for residential to medium-duty commercial applications subject to light mechanical loads (e.g., offices and stores).

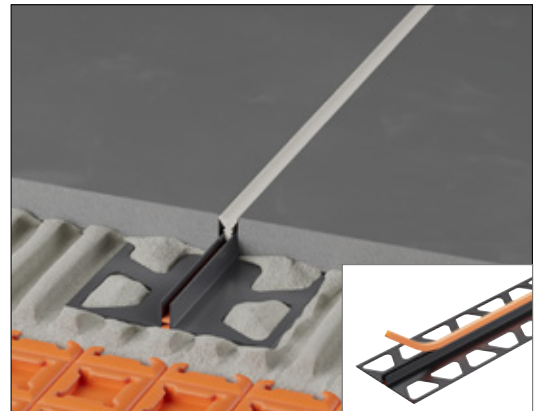
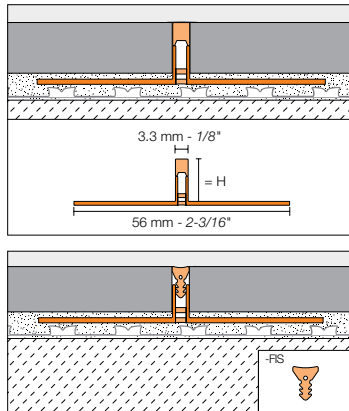

Schluter®-DILEX-FCS		
Length = 2.5 m - 8' 2-1/2"	Carrier profile with protective cover	
H = mm - in.	Item No.	\$ / Length
9 - 11/32	FCS 90	13.26
10 - 3/8	FCS 100	13.26
11 - 7/16	FCS 110	13.26
12.5 - 1/2	FCS 125	13.26

***Color Codes**

BW Bright white	SP Sand pebble	HB Light beige	PG Classic grey	G Grey
C Cream	SG Stone grey	FG Grout grey	DA Dark anthracite	GS Black

* To complete the item number, add the **color** code (e.g., FIS 300 G).

Schluter®-DILEX-FIS	
Silicone inlay	
Length = 31 m - 100'	
Item No.	\$ / Length
FIS 300 + color*	259.07



An installation tool is included with each roll of silicone inlay to facilitate cleaning of the joint and insertion of the inlay.



Schluter®-DILEX-KSN

Schluter®-DILEX-KSN is a surface joint profile with stainless steel or aluminum anchoring legs that protect tile edges and a 7/16" (11 mm)-wide, soft thermoplastic rubber movement zone that separates individual fields in the tile covering and forms the visible surface. The movement zone is available in different colors to match the grout and can be replaced if damaged. DILEX-KSN in stainless steel offers secure edge protection for surfaces exposed to heavy-duty commercial traffic (e.g., warehouses, production facilities, or shopping malls).

Note: DILEX-KSN is also available in stainless steel 316L (1.4404 = V4A). Contact Customer Service for price and availability.

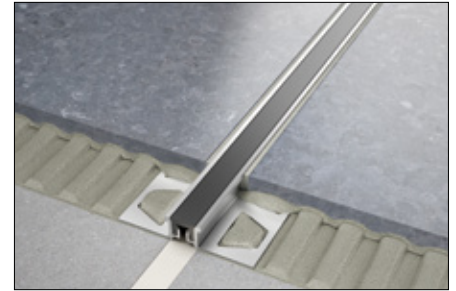
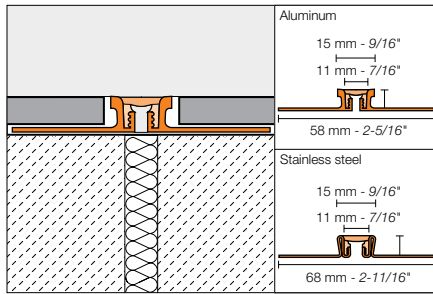

***Color Codes**

SP Sand pebble	HB Light beige	PG Classic grey	G Grey	C ¹ Cream
SG ¹ Stone grey	FG ¹ Grout grey	DA ¹ Dark anthracite	GS Black	

* To complete the item number, add the **color** code (e.g., AKSN 125 **G**).

¹ The colors cream (C), stone grey (SG), grout grey (FG), and dark anthracite (DA) are only available in the following profile sizes:
EKSN sizes 100, 110, 125, 140, and 160
AKSN sizes 100, 110, and 125

Schluter®-DILEX-KSN					
Length = 2.5 m - 8' 2-1/2"		Stainless steel 304 (1.4301 = V2A) (E)		Aluminum (A)	
H = mm - in.	Item No.	\$ / Length	Item No.	\$ / Length	
8 - 5/16	EKSN 80 + color*	100.24	AKSN 80 + color*	47.85	
10 - 3/8	EKSN 100 + color*	119.83	AKSN 100 + color*	49.93	
11 - 7/16	EKSN 110 + color*	122.82	AKSN 110 + color*	52.20	
12.5 - 1/2	EKSN 125 + color*	123.42	AKSN 125 + color*	52.01	
14 - 17/32	EKSN 140 + color*	125.55	AKSN 140 + color*	53.40	
16 - 5/8	EKSN 160 + color*	129.14	AKSN 160 + color*	55.46	
18.5 - 23/32	EKSN 185 + color*	132.01	-	-	
21 - 13/16	EKSN 210 + color*	135.60	AKSN 210 + color*	61.00	
25 - 1	EKSN 250 + color*	142.09	-	-	
30 - 1-3/16	EKSN 300 + color*	148.52	-	-	
Rubber insert replacement			KSE/ + color*		16.01

Schluter®-DILEX-AKWS

Schluter®-DILEX-AKWS is a surface joint profile with aluminum anchoring legs that protect tile edges and a 1/4" (6 mm)-wide, soft PVC movement zone that separates individual fields in the tile covering and forms the visible surface. The movement zone is available in different colors to match the grout. DILEX-AKWS is suitable for residential to medium-duty commercial applications, such as areas subject to moderate mechanical stresses, including light vehicular traffic.

An adhesive strip on the back of the profile ensures that the movement zone remains free of mortar during installation.

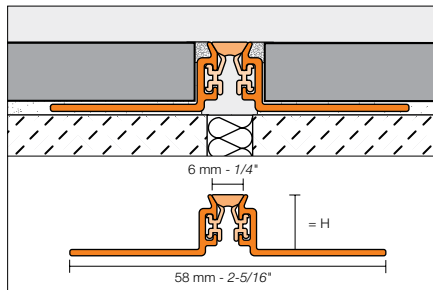

***Color codes**

SP Sand pebble	HB Light beige	PG Classic grey	G Grey	GS Black
-------------------	-------------------	--------------------	-----------	-------------

* To complete the item number, add the **color** code (e.g., AKWS 80 **G**).

Schluter®-DILEX-AKWS			
Length = 2.5 m - 8' 2-1/2"		Aluminum (A)	
H = mm - in.	Item No.	\$ / Length	
10 - 3/8	AKWS 100 + color*	38.15	
11 - 7/16	AKWS 110 + color*	38.81	
12.5 - 1/2	AKWS 125 + color*	40.94	
14 - 17/32	AKWS 140 + color*	44.37	
16 - 5/8	AKWS 160 + color*	47.14	
21 - 13/16	AKWS 210 + color*	51.30	

Schluter®-DILEX-EKSB

Schluter®-DILEX-EKSB is a surface joint profile for thinner floor coverings (e.g., VCT flooring or coatings) with stainless steel anchoring legs and a 1/4" (6 mm)-wide, soft thermoplastic rubber movement zone that separates individual fields in the floor covering and forms the visible surface. The movement zone is available in different colors. DILEX-EKSB is suitable for residential to medium-duty commercial applications.

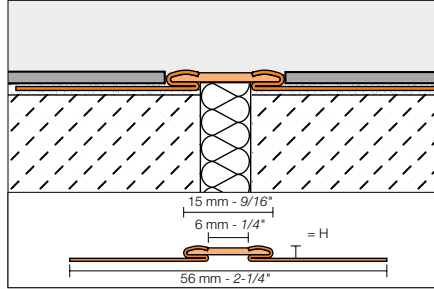

***Color Codes**

HB Light beige	PG Classic grey	G Grey	GS Black

* To complete the item number, add the **color** code (e.g., EKSB 60 **G**).

Schluter®-DILEX-EKSB		
Length = 2.5 m - 8' 2-1/2"	Stainless steel 304 (1.4301 = V2A) (E)	
H = mm - in.	Item No.	\$ / Length
2.5 - 3/32	EKSB 25 + color*	87.92
4.5 - 3/16	EKSB 45 + color*	92.98
6 - 1/4	EKSB 60 + color*	96.63

Schluter®-DILEX-EDP

Schluter®-DILEX-EDP is a stainless steel surface joint profile that protects tile edges and separates individual fields in the tile covering. The profile accommodates horizontal movement via the 15/32" (12 mm)-wide stainless steel tongue-and-groove connection, which also forms the visible surface. DILEX-EDP is particularly suited for tile surfaces subject to heavy use, including areas exposed to continuous vehicular traffic. The profile is, therefore, suited for use in production facilities, warehouses, shopping centers, and underground parking garages, or for floor surfaces maintained with cleaning machines.

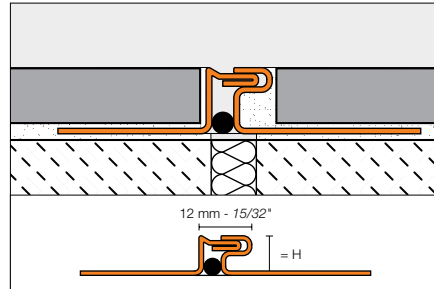

Schluter®-DILEX-EDP		
Length = 2.5 m - 8' 2-1/2"	Stainless steel 304 (1.4301 = V2A) (E)	
H = mm - in.	Item No.	\$ / Length
10 - 3/8	EDP 100	112.19
11 - 7/16	EDP 110	113.21
12.5 - 1/2	EDP 125	115.23
16 - 5/8	EDP 160	119.56
21 - 13/16	EDP 210	125.16



Schluter®-DILEX-BT

Schluter®-DILEX-BT is an expansion joint profile made of anodized aluminum that bridges expansion joints and accommodates movement via the 1-3/16" (30 mm)-wide telescopic center section, which also forms the visible surface. DILEX-BT protects tile edges and is suitable for tile surfaces exposed to foot traffic as well as vehicular traffic and is, therefore, suited for use in warehouses, production facilities, shopping centers, airports, train stations, and parking garages, or for coverings cleaned with machines.

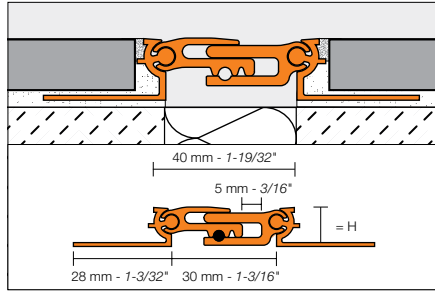

Schluter®-DILEX-BT		
Length = 2.5 m - 8' 2-1/2"	Satin anodized aluminum (AE)	
H = mm - in.	Item No.	\$/ Length
8 - 5/16	AEBT 80	161.23
10 - 3/8	AEBT 100	163.91
12.5 - 1/2	AEBT 125	167.00
15 - 9/16	AEBT 150	169.71
17.5 - 11/16	AEBT 175	173.11
20 - 3/4	AEBT 200	181.89

Schluter®-DILEX-BTO

Schluter®-DILEX-BTO is an expansion joint profile made of anodized aluminum that bridges expansion joints at floor/wall transitions and accommodates movement via the 1-3/16" (30 mm)-wide telescopic center section, which also forms the visible surface. DILEX-BTO protects tile edges and is suitable for tile surfaces exposed to foot traffic as well as vehicular traffic and is, therefore, suited for use in warehouses, production facilities, shopping centers, airports, train stations, and parking garages, or for coverings cleaned with machines.

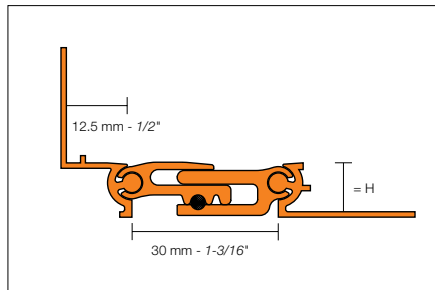

Schluter®-DILEX-BTO		
Length = 2.5 m - 8' 2-1/2"	Satin anodized aluminum (AE)	
H = mm - in.	Item No.	\$/ Length
8 - 5/16	AEBT 80/O 125	166.32
10 - 3/8	AEBT 100/O 125	167.60
12.5 - 1/2	AEBT 125/O 125	169.17
15 - 9/16	AEBT 150/O 125	170.56
17.5 - 11/16	AEBT 175/O 125	172.39
20 - 3/4	AEBT 200/O 125	176.63

Schluter®-DILEX-BTS

Schluter®-DILEX-BTS is an expansion joint profile made of anodized aluminum that bridges expansion joints and accommodates movement via the 1-3/16" (30 mm)-wide telescopic center section, which also forms the visible surface. The profile is installed in completed tile coverings. DILEX-BTS protects tile edges and is suitable for tile surfaces exposed to foot traffic as well as vehicular traffic and is, therefore, suited for use in warehouses, production facilities, shopping centers, airports, train stations, and parking garages, or for coverings cleaned with machines.

Note: DILEX-BTS can be inserted into existing joint spaces. The joints must be at least 1-3/4" (44 mm) wide and 3/8" (10 mm) deep.

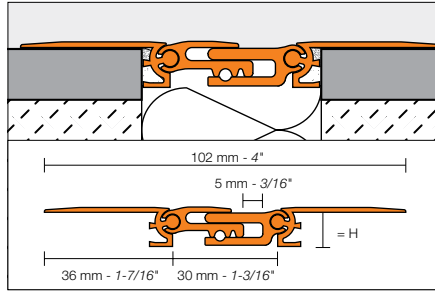

Schluter®-DILEX-BTS		
Length = 2.5 m - 8' 2-1/2"	Satin anodized aluminum (AE)	
H = mm - in.	Item No.	\$ / Length
10 - 3/8	AEBTS 100	167.00

Schluter®-DILEX-STF

Schluter®-DILEX-STF is a maintenance-free expansion joint profile system made of aluminum. The interlocking center section allows for movement in 3 directions - horizontal, vertical, and along the length of the profile. The profile is fastened to the substrate with screws for a secure installation.

Available in 6 height and width combinations, it protects tile edges and can accommodate horizontal movement up to ± 1/4" (6 mm) in the 1-9/16" (40 mm) width, and ± 3/8" (10 mm) in the 2" (50 mm) width. DILEX-STF is intended for use in areas with heavy passenger and vehicle traffic, such as warehouses, production facilities, shopping centers, airports, train stations, or floor coverings cleaned by machine.

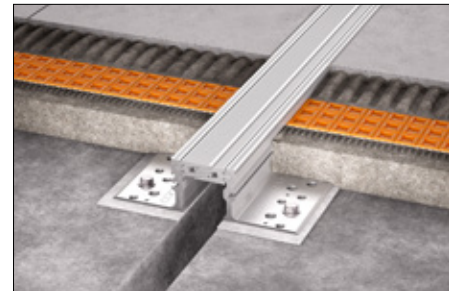
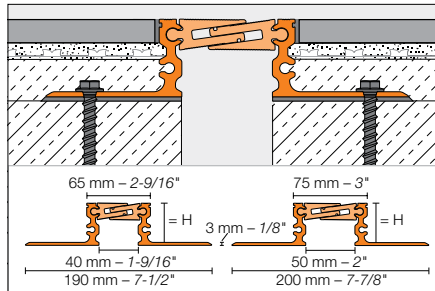

Schluter®-DILEX-STF 40		
Length = 3.05 m - 10'	Structural movement joint profile (40 mm - 1-9/16")	
H = mm - in.	Item No.	\$ / Length
22 - 7/8	ASTF 22 40/300	560.00
40 - 1-9/16	ASTF 40 40/300	640.00
52 - 2-1/16	ASTF 52 40/300	670.00

Schluter®-DILEX-STF 50		
Length = 3.05 m - 10'	Structural movement joint profile (50 mm - 2")	
H = mm - in.	Item No.	\$ / Length
22 - 7/8	ASTF 22 50/300	590.00
40 - 1-9/16	ASTF 40 50/300	670.00
52 - 2-1/16	ASTF 52 50/300	700.00



Limited quantities are kept in inventory. Please contact Customer Service for availability. Items not in stock require 6-8 weeks delivery time.



Schluter®-DILEX-AS

Schluter®-DILEX-AS is a perimeter joint profile with a rigid PVC anchoring leg and a flexible joining leg with self-adhesive tape to bond the profile to fixed building elements (e.g., bathtubs, shower trays, door and window frames). DILEX-AS isolates the tile covering from the fixed building element and accommodates movement via the flexible joining leg, which also forms the visible surface. Suitable for tiles 3/16" to 3/8" (4 – 10 mm) thick.

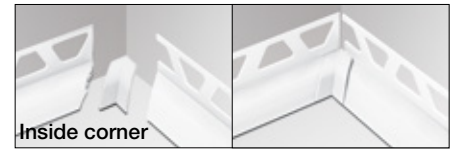
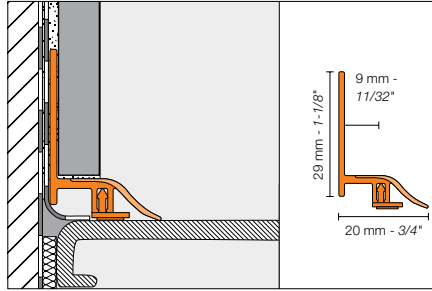

Schluter®-DILEX-AS

Length = 2.5 m - 8' 2-1/2"		PVC perimeter joint profile Bright white (BW)						
H = mm - in.	Profile	\$ / Length	End cap (Right)	End cap (Left)	Inside corner	\$ / Unit	2 inside corners + 1 right end cap + 1 left end cap	\$ / Set
9 - 11/32	AS20BW	32.56	EKR/AS20BW	EKL/AS20BW	I/AS20BW	3.88	EKI/AS20BW	14.05

Schluter®-DILEX-KSA

Schluter®-DILEX-KSA is a perimeter joint profile with a stainless steel or aluminum anchoring leg and a 3/8" (10 mm)-wide, soft thermoplastic rubber movement zone that isolates the tile covering from fixed building elements (e.g., window and door frames). The movement zone is available in different colors to match the grout and can be replaced if damaged. The profile also features a self-adhesive strip that allows it to bond to the fixed building elements.

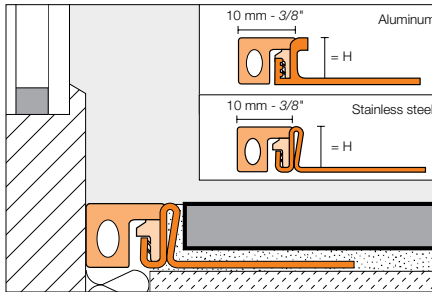

Note: DILEX-KSA is also available in stainless steel 316L (1.4404 = V4A). Contact Customer Service for price and availability.

Schluter®-DILEX-KSA

Length = 2.5 m - 8' 2-1/2"		Stainless steel 304 (1.4301 = V2A) (E)		Aluminum (A)	
H = mm - in.	Item No.	\$ / Length	Item No.	\$ / Length	Rubber insert replacement
8 - 5/16	EKSA 80 + color*	69.78	AKSA 80 + color*	38.85	KSAE/+ color* 17.17
10 - 3/8	EKSA 100 + color*	85.04	AKSA 100 + color*	39.90	
11 - 7/16	EKSA 110 + color*	87.17	AKSA 110 + color*	40.89	
12.5 - 1/2	EKSA 125 + color*	87.60	AKSA 125 + color*	41.24	
14 - 17/32	EKSA 140 + color*	89.10	AKSA 140 + color*	43.08	
16 - 5/8	EKSA 160 + color*	91.66	-	-	
18.5 - 23/32	EKSA 185 + color*	93.70	-	-	
21 - 13/16	EKSA 210 + color*	96.24	-	-	
25 - 1	EKSA 250 + color*	100.85	-	-	
30 - 1-3/16	EKSA 300 + color*	105.44	-	-	

*Color Codes



* To complete the item number, add the color code (e.g., EKSA 80 G).

Schluter®-DILEX-BWA

Schluter®-DILEX-BWA is a perimeter joint profile with a rigid PVC anchoring leg and a 3/16" (5 mm)-wide, soft CPE movement zone that isolates the tile covering from fixed building elements (e.g., bathtubs, shower trays, door and window frames) and forms the visible surface. The movement zone is available in different colors to match the grout. The profile also features a dovetailed channel made of rigid PVC that can be bonded to the fixed building elements.

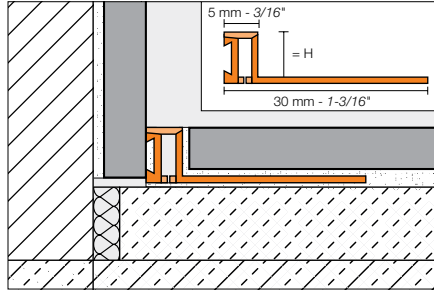

***Color Codes**

BW Bright white	SP Sand pebble	HB Light beige	PG Classic grey	G Grey
C Cream	SG Stone grey	FG Grout grey	DA Dark anthracite	GS Black

* To complete the item number, add the **color** code (e.g., BWA 80 **G**).
 ** BWA 45 is not available in Sand Pebble (SP)

Schluter®-DILEX-BWA			
Length = 2.5 m - 8' 2-1/2"	PVC perimeter joint profile		
H = mm - in.	Item No.		\$ / Length
4.5 - 3/16	BWA 45 + color**		20.80
6 - 1/4	BWA 60 + color*		22.17
8 - 5/16	BWA 80 + color*		23.57
10 - 3/8	BWA 100 + color*		24.27
12.5 - 1/2	BWA 125 + color*		24.96

Schluter®-DILEX-EKE

Schluter®-DILEX-EKE is a corner movement joint profile with rigid PVC anchoring legs and a 3/16" (5 mm)-wide, soft CPE movement zone that separates individual tile fields at floor/wall transitions and inside wall corners and forms the visible surface. The movement zone is available in different colors to match the grout and forms a discreet, uniform joint. DILEX-EKE prevents surface water penetration and prevents sound bridges, making it ideal for floor/wall transitions in sound-rated floors.

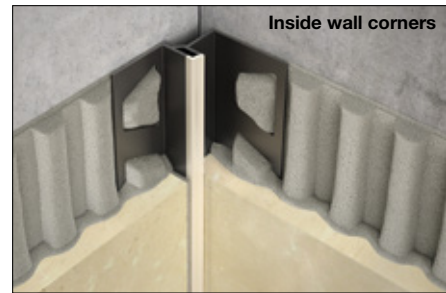
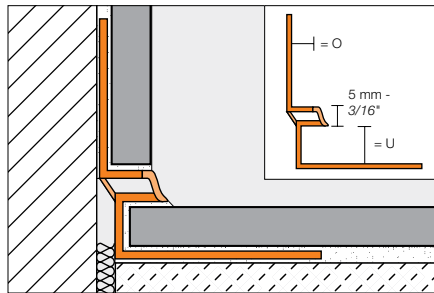

***Color Codes**

BW Bright white	SP Sand pebble	HB Light beige	PG Classic grey	G Grey
GS Black				

* To complete the item number, add the **color** code (e.g., EKE U 8 / O 7 **BW**).

Schluter®-DILEX-EKE			
Corner movement profile			
Length = 2.5 m - 8' 2-1/2"	U = floor or wall, O = wall		\$ / Length
	EKE U 8/O 7 + color*		19.84
	EKE U 9/O 8 + color*		20.37
	EKE U 11/O 10 + color*		20.51
	EKE U 13/O 12 + color*		20.99
	EKE U 15/O 14 + color*		21.64



U: 8 mm = 5/16"	9 mm = 11/32"	11 mm = 7/16"	13 mm = 33/64"	15 mm = 9/16"
O: 7 mm = 9/32"	8 mm = 5/16"	10 mm = 3/8"	12 mm = 1/2"	14 mm = 17/32"

Get perfect cuts!

Schluter®-SNIPS for PVC profiles. See page 197 for more information.





Schluter®-DILEX-HKW

Schluter®-DILEX-HKW is a PVC cove-shaped profile for inside wall corners and floor/wall transitions in applications where limited movement is expected. The profile provides an 11/16" (18 mm) radius to prevent the accumulation of dirt and makes cleaning simple. DILEX-HKW accommodates wall and floor tiles that are of the same thickness. DILEX-HKW prevents surface water penetration and meets the maintenance and hygienic requirements of commercial kitchens, bathrooms, food processing plants, or any tiled environment where a sanitary cove base is desired.

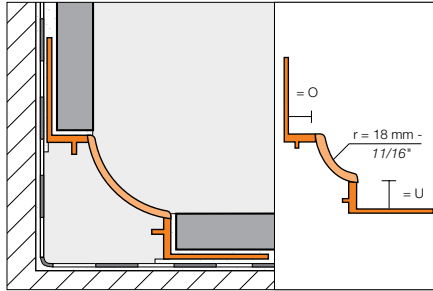

Outside corner (90°)

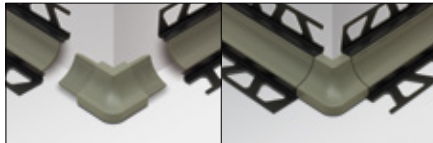

Inside corner, 2-way (90°)

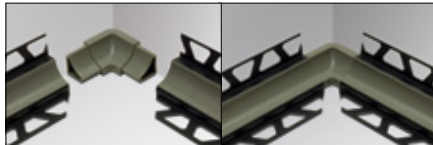

Inside corner, 3-way (90°)



End cap

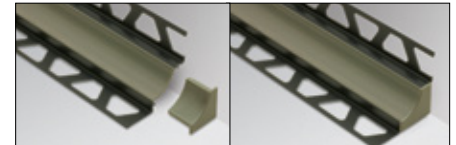

***Color Codes**



* To complete the item number, add the color code (e.g., HKW U 9 / O 9 HB).

U: 7 mm = 9/32" 9 mm = 11/32" 11 mm = 7/16"
O: 7 mm = 9/32" 9 mm = 11/32" 11 mm = 7/16"

Schluter®-DILEX-HKW

Length = 2.5 m - 8' 2-1/2"
 U = floor or wall, O = wall

Cove base profile

Profile	\$ / Length	Outside corner, 90°	Inside corner, 90° (2-way)	Inside corner, 90° (3-way)	End cap	\$ / Unit
HKW U 7/O 7 + color*	26.46					
HKW U 9/O 9 + color*	26.46	A/HKW/+ color*	I/HKW 2 R18/+ color*	I/HKW 3 R18/+ color*	E/HKW/G (Grey only)	4.99
HKW U 11/O 11 + color*	26.46					

Schluter®-DILEX-HK

Schluter®-DILEX-HK is a cove-shaped profile with rigid PVC anchoring legs and a soft CPE movement zone that separates individual tile fields at floor/wall transitions and forms the visible surface. The profile provides an 11/16" (18 mm) radius to prevent the accumulation of dirt and makes cleaning simple. DILEX-HK accommodates wall and floor tiles of dissimilar thicknesses and features a tile pocket that hides cut tile edges. DILEX-HKW integrates with DILEX-HK where cove trim is required for inside wall corners. DILEX-HK prevents surface water penetration and meets the maintenance and hygienic requirements of commercial kitchens, bathrooms, food processing plants, or any tiled environment where a sanitary cove base is desired. DILEX-HK also prevents sound bridges, making it ideal for floor/wall transitions in sound-rated floors.

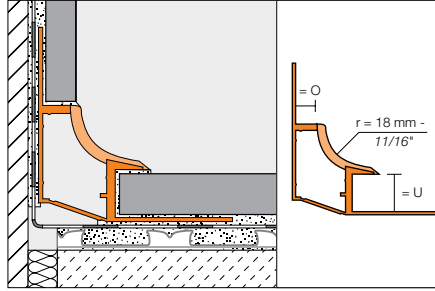

Outside corner (90°)

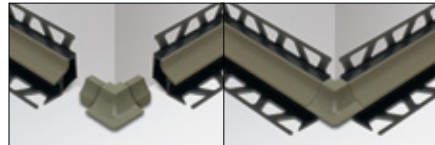

Connector



Inside corner, 2-way (90°)

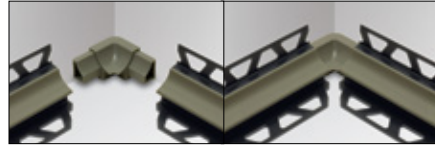

End cap (right or left)

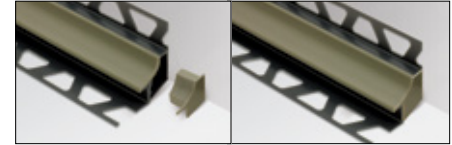

Inside corner, 3-way (90°)



Note: 3-way corners are to be used with DILEX-HKW (page 83) on the vertical.

***Color Codes**



* To complete the item number, add the **color** code (e.g., HK U 12 / O 9 **BW**).

U: 12 mm = 1/2"
O: 9 mm = 11/32"

Schluter®-DILEX-HK

Length = 2.5 m - 8' 2-1/2"		Cove base profile			
U = floor or wall, O = wall					
Profile	\$ / Length	Outside corner, 90°	Inside corner, 90° (2-way)	Inside corner, 90° (3-way)	\$ / Unit
HK U 12/O 9 + color*	38.01	A/HK/+ color*	I/HK 2 R18/+ color*	I/HK 3 R18/+ color*	4.99
Connector		V/HK			2.11
End cap (Left)		EL/HK/G (Grey only)			4.99
End cap (Right)		ER/HK/G (Grey only)			4.99



Schluter®-DILEX-AHK

Schluter®-DILEX-AHK is a cove-shaped profile with a single trapezoid-perforated anchoring leg for inside wall corners, countertop/backsplash transitions and floor/wall transitions in applications where limited movement is expected. DILEX-AHK provides a 3/8" (10 mm) radius to prevent accumulation of dirt and makes cleaning simple. DILEX-AHK is available in anodized aluminum and textured color-coated aluminum. DILEX-AHK prevents surface water penetration and meets the maintenance and hygienic requirements of commercial kitchens, bathrooms, food processing plants, or any tiled environment where a sanitary cove base is desired.

Note: 90° outside corners are available in 2 configurations. The "round" corner (E90/) features a rounded front that integrates with RONDEC, while the "square" corner (E90Q/) features a square shaped front that integrates with QUADDEC.

NEW!

Now available in Matte White and Matte Black!

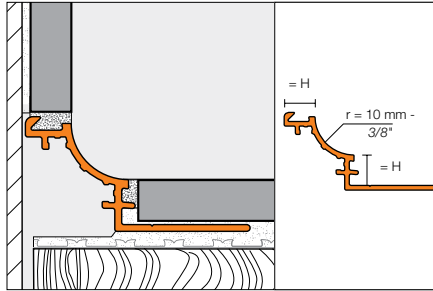

Outside corner, round (90° or 135°)

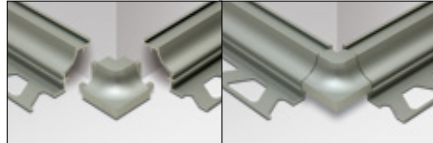

Inside corner (90° or 135°)

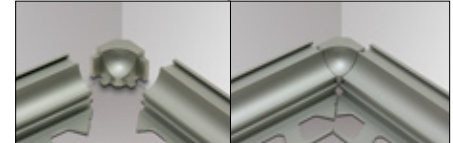

90° inside corners can be used 2-way or 3-way.

Outside corner, square (90°)

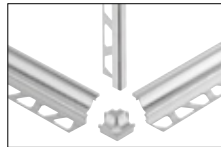

Connector



End cap

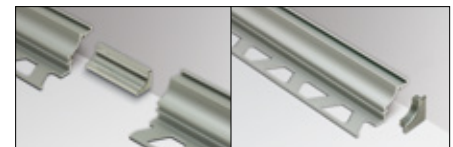

Schluter®-DILEX-AHK							
Length = 2.5 m - 8' 2-1/2"		Satin anodized aluminum (AE)					
H = mm - in.	Profile	\$/ Length	Outside corner, 90°	Outside corner, 135°	Inside corner, 90°	Inside corner, 135°	\$/ Unit
8 - 5/16	AHK 1S 80 AE	31.86	E 90/AHK 1S/AE	E 135/AHK 1S/AE	I 90/AHK 1S/AE	I 135/AHK 1S/AE	27.94
10 - 3/8	AHK 1S 100 AE	33.17					
12.5 - 1/2	AHK 1S 125 AE	34.69					
Outside corner square, 90°	E90 Q/AHK 1S/AE						27.08
Connector	V/AHK						4.72
End cap	E/AHK 1S/AE						16.75

Length = 2.5 m - 8' 2-1/2"		Polished chrome anod. alu. (ACG)					
H = mm - in.	Profile	\$/ Length	Outside corner, 90°	Outside corner, 135°	Inside corner, 90°	Inside corner, 135°	\$/ Unit
8 - 5/16	AHK 1S 80 ACG	55.20	E 90/AHK 1S/ACG	E 135/AHK 1S/ACG	I 90/AHK 1S/ACG	I 135/AHK 1S/ACG	32.18
10 - 3/8	AHK 1S 100 ACG	56.36					
12.5 - 1/2	AHK 1S 125 ACG	57.62					
Outside corner square, 90°	E90 Q/AHK 1S/ACG						31.60
Connector	V/AHK						4.72
End cap	E/AHK 1S/ACG						20.98

Length = 2.5 m - 8' 2-1/2"		Brushed chrome anod. alu. (ACGB)					
H = mm - in.	Profile	\$/ Length	Outside corner, 90°	Outside corner, 135°	Inside corner, 90°	Inside corner, 135°	\$/ Unit
8 - 5/16	AHK 1S 80 ACGB	49.39	E 90/AHK 1S/ACGB	E 135/AHK 1S/ACGB	I 90/AHK 1S/ACGB	I 135/AHK 1S/ACGB	32.18
10 - 3/8	AHK 1S 100 ACGB	50.76					
12.5 - 1/2	AHK 1S 125 ACGB	52.28					
Connector	V/AHK						4.72
End cap	E/AHK 1S/ACGB						20.98

Schluter®-DILEX-AHK							
Length = 2.5 m - 8' 2-1/2"	Satin nickel anod. alu. (AT)						
H = mm - in.	Profile	\$ / Length	Outside corner, 90°	Outside corner, 135°	Inside corner, 90°	Inside corner, 135°	\$ / Unit
8 - 5/16	AHK 1S 80 AT	36.85	E 90/AHK 1S/AT	E 135/AHK 1S/AT	I 90/AHK 1S/AT	I 135/AHK 1S/AT	27.94
10 - 3/8	AHK 1S 100 AT	38.21					
12.5 - 1/2	AHK 1S 125 AT	39.75					
15 - 9/16	AHK 1S 150 AT	41.27					
Outside corner square, 90°	E90 Q/AHK 1S/AT						27.08
Connector	V/AHK						4.72
End cap	E/AHK 1S/AT						16.75

Length = 2.5 m - 8' 2-1/2"	Polished nickel anod. alu. (ATG)						
H = mm - in.	Profile	\$ / Length	Outside corner, 90°	Outside corner, 135°	Inside corner, 90°	Inside corner, 135°	\$ / Unit
8 - 5/16	AHK 1S 80 ATG	58.34	E 90/AHK 1S/ATG	E 135/AHK 1S/ATG	I 90/AHK 1S/ATG	I 135/AHK 1S/ATG	32.18
10 - 3/8	AHK 1S 100 ATG	59.50					
12.5 - 1/2	AHK 1S 125 ATG	60.75					
Connector	V/AHK						
End cap	E/AHK 1S/ATG						20.98

Length = 2.5 m - 8' 2-1/2"	Brushed nickel anod. alu. (ATGB)						
H = mm - in.	Profile	\$ / Length	Outside corner, 90°	Outside corner, 135°	Inside corner, 90°	Inside corner, 135°	\$ / Unit
8 - 5/16	AHK 1S 80 ATGB	53.11	E 90/AHK 1S/ATGB	E 135/AHK 1S/ATGB	I 90/AHK 1S/ATGB	I 135/AHK 1S/ATGB	32.18
10 - 3/8	AHK 1S 100 ATGB	54.47					
12.5 - 1/2	AHK 1S 125 ATGB	55.99					
Connector	V/AHK						
End cap	E/AHK 1S/ATGB						20.98

Length = 2.5 m - 8' 2-1/2"	Satin copper anod. alu. (AK)						
H = mm - in.	Profile	\$ / Length	Outside corner, 90°	Outside corner, 135°	Inside corner, 90°	Inside corner, 135°	\$ / Unit
8 - 5/16	AHK 1S 80 AK	36.85	E 90/AHK 1S/AK	E 135/AHK 1S/AK	I 90/AHK 1S/AK	I 135/AHK 1S/AK	27.94
10 - 3/8	AHK 1S 100 AK	38.21					
12.5 - 1/2	AHK 1S 125 AK	39.75					
Connector	V/AHK						
End cap	E/AHK 1S/AK						16.75

Length = 2.5 m - 8' 2-1/2"	Polished copper anod. alu. (AKG)						
H = mm - in.	Profile	\$ / Length	Outside corner, 90°	Outside corner, 135°	Inside corner, 90°	Inside corner, 135°	\$ / Unit
8 - 5/16	AHK 1S 80 AKG	58.34	E 90/AHK 1S/AKG	E 135/AHK 1S/AKG	I 90/AHK 1S/AKG	I 135/AHK 1S/AKG	32.18
10 - 3/8	AHK 1S 100 AKG	59.50					
12.5 - 1/2	AHK 1S 125 AKG	60.75					
Connector	V/AHK						
End cap	E/AHK 1S/AKG						20.98

Length = 2.5 m - 8' 2-1/2"	Brushed copper anod. alu. (AKGB)						
H = mm - in.	Profile	\$ / Length	Outside corner, 90°	Outside corner, 135°	Inside corner, 90°	Inside corner, 135°	\$ / Unit
8 - 5/16	AHK 1S 80 AKGB	53.11	E 90/AHK 1S/AKGB	E 135/AHK 1S/AKGB	I 90/AHK 1S/AKGB	I 135/AHK 1S/AKGB	32.18
10 - 3/8	AHK 1S 100 AKGB	54.47					
12.5 - 1/2	AHK 1S 125 AKGB	55.99					
Connector	V/AHK						
End cap	E/AHK 1S/AKGB						20.98



Schluter®-DILEX-AHK							
Length = 2.5 m - 8' 2-1/2"		Satin brass anod. alu. (AM)					
H = mm - in.	Profile	\$/ Length	Outside corner, 90°	Outside corner, 135°	Inside corner, 90°	Inside corner, 135°	\$/ Unit
8 - 5/16	AHK 1S 80 AM	36.85	E 90/AHK 1S/AM	E 135/AHK 1S/AM	I 90/AHK 1S/AM	I 135/AHK 1S/AM	27.94
10 - 3/8	AHK 1S 100 AM	38.21					
12.5 - 1/2	AHK 1S 125 AM	39.75					
Connector	V/AHK						4.72
End cap	E/AHK 1S/AM						16.75

Length = 2.5 m - 8' 2-1/2"		Polished brass anod. alu. (AMG)					
H = mm - in.	Profile	\$/ Length	Outside corner, 90°	Outside corner, 135°	Inside corner, 90°	Inside corner, 135°	\$/ Unit
8 - 5/16	AHK 1S 80 AMG	56.85	E 90/AHK 1S/AMG	E 135/AHK 1S/AMG	I 90/AHK 1S/AMG	I 135/AHK 1S/AMG	32.18
10 - 3/8	AHK 1S 100 AMG	57.96					
12.5 - 1/2	AHK 1S 125 AMG	59.25					
Connector	V/AHK						4.72
End cap	E/AHK 1S/AMG						20.98

Length = 2.5 m - 8' 2-1/2"		Brushed brass anod. alu. (AMGB)					
H = mm - in.	Profile	\$/ Length	Outside corner, 90°	Outside corner, 135°	Inside corner, 90°	Inside corner, 135°	\$/ Unit
8 - 5/16	AHK 1S 80 AMGB	51.33	E 90/AHK 1S/AMGB	E 135/AHK 1S/AMGB	I 90/AHK 1S/AMGB	I 135/AHK 1S/AMGB	32.18
10 - 3/8	AHK 1S 100 AMGB	52.66					
12.5 - 1/2	AHK 1S 125 AMGB	54.18					
Connector	V/AHK						4.72
End cap	E/AHK 1S/AMGB						20.98

Length = 2.5 m - 8' 2-1/2"		Brushed graphite anod. alu. (AGRB)					
H = mm - in.	Profile	\$/ Length	Outside corner, 90°	Outside corner, 135°	Inside corner, 90°	Inside corner, 135°	\$/ Unit
8 - 5/16	AHK 1S 80 AGRB	53.11	E 90/AHK 1S/AGRB	E 135/AHK 1S/AGRB	I 90/AHK 1S/AGRB	I 135/AHK 1S/AGRB	32.18
10 - 3/8	AHK 1S 100 AGRB	54.47					
12.5 - 1/2	AHK 1S 125 AGRB	55.99					
15 - 9/16	AHK 1S 150 AGRB	57.68					
Connector	V/AHK						4.72
End cap	E/AHK 1S/AGRB						20.98



DILEX-AHK in dark anthracite (page 88)

Schluter®-TRENDLINE Textured Color-coated Aluminum

Schluter®-DILEX-AHK							
Length = 2.5 m - 8' 2-1/2"	Textured color-coated aluminum (TS)						
H = mm - in.	Profile	\$ / Length	Outside corner, 90°	Outside corner, 135°	Inside corner, 90°	Inside corner, 135°	\$ / Unit
8 - 5/16	AHK 1S 80 + color*	55.71	E 90/AHK 1S/ + color*	E 135/AHK 1S/ + color*	I 90/AHK 1S/ + color*	I 135/AHK 1S/ + color*	33.76
10 - 3/8	AHK 1S 100 + color*	56.52					
12.5 - 1/2	AHK 1S 125 + color*	57.71					
15 - 9/16	AHK 1S 150 + color*	58.86	E90 Q/AHK 1S/+ color*				31.35
Outside corner square, 90°							
Connector	V/AHK						4.72
End cap	E/AHK 1S/+ color*						22.34

*Color Codes



* To complete the item number, add the color code (e.g., AHK 1S 80 TSB).

NEW Colors! Matte White and Matte Black

Matte color-coated aluminum							
H = mm - in.	Profile	\$ / Length	Outside corner, 90°	Outside corner, 135°	Inside corner, 90°	Inside corner, 135°	\$ / Unit
8 - 5/16	AHK 1S 80 + color*	44.57	E 90/AHK 1S/ + color*	E 135/AHK 1S/ + color*	I 90/AHK 1S/ + color*	I 135/AHK 1S/ + color*	27.01
10 - 3/8	AHK 1S 100 + color*	45.22					
12.5 - 1/2	AHK 1S 125 + color*	46.17					
Outside corner square, 90°	E90 Q/AHK 1S/+ color*						25.08
Connector	V/AHK						4.72
End cap	E/AHK 1S/+ color*						17.87

*Color Codes

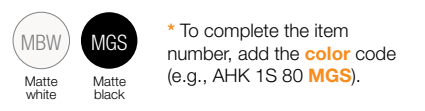

* To complete the item number, add the color code (e.g., AHK 1S 80 MGS).



Schluter®-DILEX-AHKA

Schluter®-DILEX-AHKA is a cove-shaped profile for transitions between walls to be tiled and previously finished floors. DILEX-AHKA is available in anodized aluminum and textured color-coated aluminum. The profile features a single-trapezoid perforated anchoring leg that is secured in the mortar bond coat and a dovetailed channel, which can be bonded to floor surfaces using Schluter®-KERDI-FIX, epoxy resin, silicone, thin-set mortar, etc. A 3/8" (10 mm) radius cove section forms the visible surface and prevents the accumulation of dirt, making cleaning simple. DILEX-AHKA prevents surface water penetration and meets the maintenance and hygienic requirements of commercial kitchens, bathrooms, food processing plants, or any tiled environment where a sanitary cove base is desired. DILEX-AHKA integrates with the Schluter®-DILEX-AHK and Schluter®-RONDEC profiles at 90° inside and outside vertical wall corners, respectively.

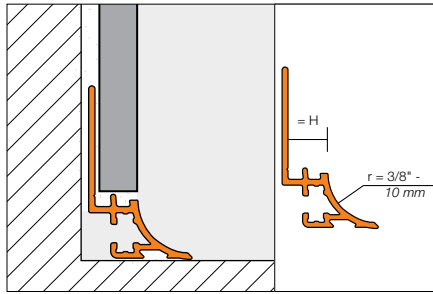

Outside corner (90° or 135°)

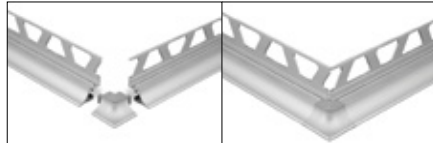

Inside corner (90° or 135°)

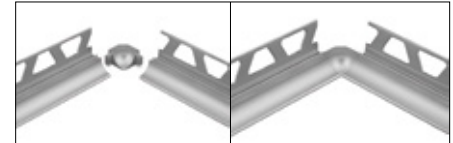

End cap



90° inside corners can be used 2-way, or 3-way when combined with DILEX-AHK on the vertical inside corner.

NEW!

Now available in Matte White and Matte Black!

Schluter®-DILEX-AHKA								
Length = 2.5 m - 8' 2-1/2"		Satin anodized aluminum (AE)						
H = mm - in.	Profile	\$/ Length	Outside corner, 90°	Outside corner, 135°	Inside corner, 90°	Inside corner, 135°	\$/ Unit	
8 - 5/16	AHKA 80 AE	31.86	E 90/AHKA/AE	E 135/AHKA/AE	I 90/AHKA/AE	I 135/AHKA/AE	27.94	
10 - 3/8	AHKA 100 AE	33.17						
12.5 - 1/2	AHKA 125 AE	34.69						
15 - 9/16	AHKA 150 AE	35.72						
End cap (left)			EL/AHKA/AE				16.75	
End cap (right)			ER/AHKA/AE				16.75	

Length = 2.5 m - 8' 2-1/2"		Brushed chrome anod. alu. (ACGB)						
H = mm - in.	Profile	\$/ Length	Outside corner, 90°	Outside corner, 135°	Inside corner, 90°	Inside corner, 135°	\$/ Unit	
8 - 5/16	AHKA 80 ACGB	49.39	E 90/AHKA/ACGB	E 135/AHKA/ACGB	I 90/AHKA/ACGB	I 135/AHKA/ACGB	32.18	
10 - 3/8	AHKA 100 ACGB	50.76						
12.5 - 1/2	AHKA 125 ACGB	52.28						
15 - 9/16	AHKA 150 ACGB	53.86						
End cap (left)			EL/AHKA/ACGB				20.98	
End cap (right)			ER/AHKA/ACGB				20.98	

Length = 2.5 m - 8' 2-1/2"		Satin nickel anod. alu. (AT)						
H = mm - in.	Profile	\$/ Length	Outside corner, 90°	Outside corner, 135°	Inside corner, 90°	Inside corner, 135°	\$/ Unit	
8 - 5/16	AHKA 80 AT	36.85	E 90/AHKA/AT	E 135/AHKA/AT	I 90/AHKA/AT	I 135/AHKA/AT	27.94	
10 - 3/8	AHKA 100 AT	38.21						
12.5 - 1/2	AHKA 125 AT	39.75						
15 - 9/16	AHKA 150 AT	41.27						
End cap (left)			EL/AHKA/AT				16.75	
End cap (right)			ER/AHKA/AT				16.75	

Schluter®-DILEX-AHKA							
Length = 2.5 m - 8' 2-1/2"	Brushed nickel anod. alu. (ATGB)						
H = mm - in.	Profile	\$ / Length	Outside corner, 90°	Outside corner, 135°	Inside corner, 90°	Inside corner, 135°	\$ / Unit
8 - 5/16	AHKA 80 ATGB	53.11	E 90/AHKA/ATGB	E 135/AHKA/ATGB	I 90/AHKA/ATGB	I 135/AHKA/ATGB	32.18
10 - 3/8	AHKA 100 ATGB	54.47					
12.5 - 1/2	AHKA 125 ATGB	55.99					
15 - 9/16	AHKA 150 ATGB	57.68					
End cap (left)	EL/AHKA/ATGB						20.98
End cap (right)	ER/AHKA/ATGB						20.98

Schluter®-TRENDLINE Textured Color-coated Aluminum

Length = 2.5 m - 8' 2-1/2"	Textured color-coated aluminum (TS)						
H = mm - in.	Profile	\$ / Length	Outside corner, 90°	Outside corner, 135°	Inside corner, 90°	Inside corner, 135°	\$ / Unit
8 - 5/16	AHKA 80 + color*	55.71	E 90/AHKA/ + color*	E 135/AHKA/ + color*	I 90/AHKA/ + color*	I 135/AHKA/ + color*	33.76
10 - 3/8	AHKA 100 + color*	56.52					
12.5 - 1/2	AHKA 125 + color*	57.71					
15 - 9/16	AHKA 150 + color*	58.86					
End cap (left)	EL/AHKA/+ color*						21.79
End cap (right)	ER/AHKA/+ color*						21.79

*Color Codes



* To complete the item number, add the color code (e.g., AHKA 80 TSB).

NEW Colors! Matte White and Matte Black

Length = 2.5 m - 8' 2-1/2"	▲ Matte color-coated aluminum						
H = mm - in.	Profile	\$ / Length	Outside corner, 90°	Outside corner, 135°	Inside corner, 90°	Inside corner, 135°	\$ / Unit
8 - 5/16	AHKA 80 + color*	44.57	E 90/AHKA/ + color*	E 135/AHKA/ + color*	I 90/AHKA/ + color*	I 135/AHKA/ + color*	27.01
10 - 3/8	AHKA 100 + color*	45.22					
12.5 - 1/2	AHKA 125 + color*	46.17					
End cap (left)	EL/AHKA/+ color*						17.87
End cap (right)	ER/AHKA/+ color*						17.87

*Color Codes



* To complete the item number, add the color code (e.g., AHKA 80 MGS).



Schluter®-DILEX-PHK

Schluter®-DILEX-PHK is a PVC, cove-shaped profile for inside wall corners, countertop/backsplash transitions and floor/wall transitions in applications where limited movement is expected. DILEX-PHK provides a 3/8" (10 mm) radius to prevent the accumulation of dirt and makes cleaning simple. DILEX-PHK prevents surface water penetration and meets the maintenance and hygienic requirements of commercial kitchens, bathrooms, food processing plants, or any tiled environment where a sanitary cove base is desired.

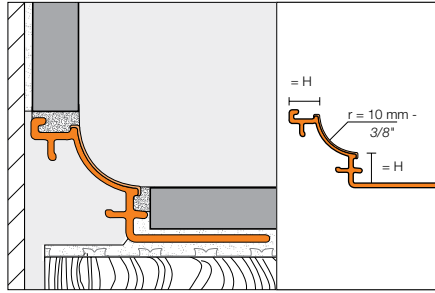

Outside corner (90° or 135°)

Inside corner (90° or 135°)

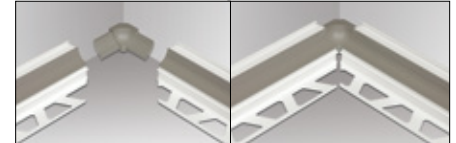

90° inside corners can be used 2-way or 3-way.

***Color Codes**



* To complete the item number, add the color code (e.g., PHK 1S 80 **BW**).

Connector

End cap



Schluter®-DILEX-PHK

Length = 2.5 m - 8' 2-1/2"		Cove base profile						
H = mm - in.	Profile	\$/ Length	Outside corner, 90°	Outside corner, 135°	Inside corner, 90°	Inside corner, 135°	\$/ Unit	
8 - 5/16	PHK 1S 80 + color*	23.41	E 90/PHK 1S/ + color*	E 135/PHK 1S/ + color*	I 90/PHK 1S/ + color*	I 135/PHK 1S/ + color*	3.34	
10 - 3/8	PHK 1S 100 + color*	24.68						
12.5 - 1/2	PHK 1S 125 + color*	25.04						
Connector	V/PHK						1.86	
End cap	E/PHK 1S/ + color*						3.34	

Schluter®-DILEX-EHK

Schluter®-DILEX-EHK is a stainless steel, cove-shaped profile for inside wall corners, countertop/backsplash transitions and floor/wall transitions in applications where limited movement is expected. DILEX-EHK provides a 23/32" (18.5 mm) radius to prevent the accumulation of dirt and makes cleaning simple. DILEX-EHK prevents surface water penetration and meets the maintenance and hygienic requirements of commercial kitchens, bathrooms, food processing plants, or any tiled environment where a sanitary cove base is desired.

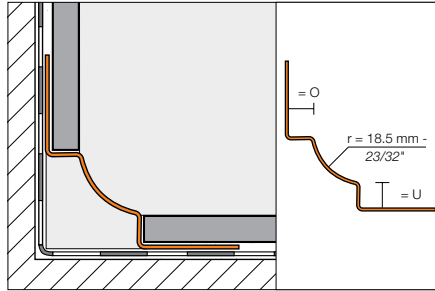

Outside corner (90° or 135°)

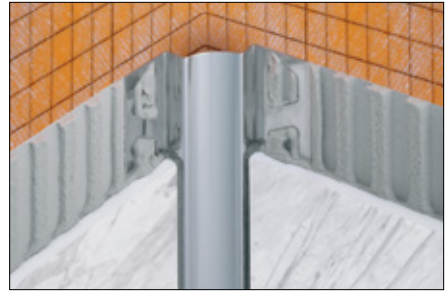

Inside corner, 3-way (90°)

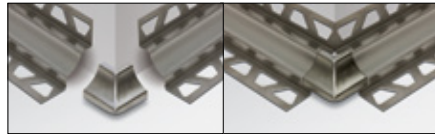

Inside corner, 2-way (90° or 135°)

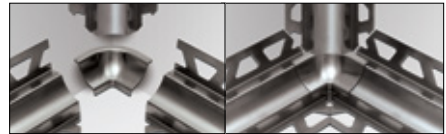

Connector

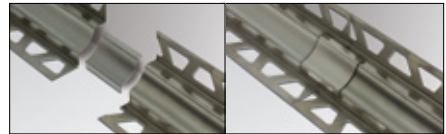
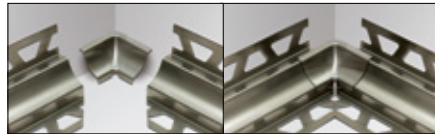

End cap

U:	7 mm = 9/32"	9 mm = 11/32"
	11 mm = 7/16"	16 mm = 5/8"
O:	7 mm = 9/32"	9 mm = 11/32"
	11 mm = 7/16"	16 mm = 5/8"

Schluter®-DILEX-EHK							
Stainless steel 304 (1.4301 = V2A) (E)	Stainless steel 316L (1.4404 = V4A) (EV4A)						
Length = 2.5 m - 8' 2-1/2" U = floor or wall, O = wall Profile	\$/ Length	Outside corner, 90°	Inside corner, 90° (2-way)	Inside corner, 90° (3-way)	Outside corner, 135°	Inside corner, 135°	\$/ Unit
EHK U 7/O 7	81.48	A/EHK 2 R18	I/EHK 2 R18	I/EHK 3 R18	E135/EHK2R18	I135/EHK2R18	9.58
EHK U 9/O 9	83.87						
EHK U 11/O 11	86.55						
Connector		V/EHK					9.58
End cap		E/HKW/G (Grey PVC only)					4.99

Stainless steel 316L (1.4404 = V4A) (EV4A)							
Length = 2.5 m - 8' 2-1/2" U = floor or wall, O = wall Profile	\$/ Length	Outside corner, 90°	Inside corner, 90° (2-way)	Inside corner, 90° (3-way)	Outside corner, 135°	Inside corner, 135°	\$/ Unit
EHK U 7/O 7/V4A	89.59	A/EHK 2 R18	I/EHK 2 R18	I/EHK 3 R18	E135/EHK 2 R18	I135/EHK 2 R18	9.58
EHK U 9/O 9/V4A	92.25						
EHK U 11/O 11/V4A	95.19						
EHK U 16/O 16/V4A	97.09						
Connector		V/EHK					9.58
End cap		E/HKW/G (Grey PVC only)					4.99

Brushed Stainless steel 304 (1.4301 = V2A) (EB)							
Brushed Stainless steel 316L (1.4404 = V4A) (EBV4A)							
Length = 2.5 m - 8' 2-1/2" U = floor or wall, O = wall Profile	\$/ Length	Outside corner, 90°	Inside corner, 90° (2-way)	Inside corner, 90° (3-way)	Outside corner, 135°	Inside corner, 135°	\$/ Unit
EBHK U 7/O 7	105.92	A/EBHK 2 R18	I/EBHK 2 R18	I/EBHK 3 R18	E135/EBHK2R18	I135/EBHK2R18	12.43
EBHK U 9/O 9	109.03						
EBHK U 11/O 11	112.50						
Connector		V/EBHK					12.43
End cap		E/HKW/G (Grey PVC only)					4.99



Schluter®-DILEX-HKS

Schluter®-DILEX-HKS is a stainless steel, cove-shaped profile for inside wall corners, and floor/wall transitions in applications. DILEX-HKS features a soft, thermoplastic rubber movement zone to absorb larger movements at floor/wall transitions and inside wall corners and a 23/32" (18.5 mm) radius to prevent the accumulation of dirt and makes cleaning simple. DILEX-HKS prevents surface water penetration and meets the maintenance and hygienic requirements of commercial kitchens, bathrooms, food processing plants, or any tiled environment where a sanitary cove base is desired.

Note: DILEX-HKS is also available in stainless steel 316L (1.4404 = V4A). Contact Customer Service for price and availability.

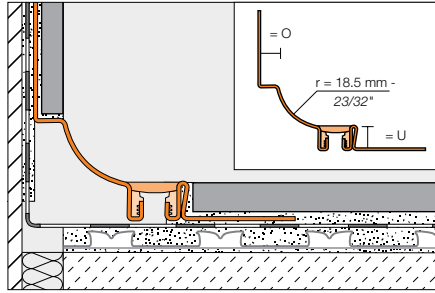

Outside corner (90°)



Inside corner, 2-way (90°)

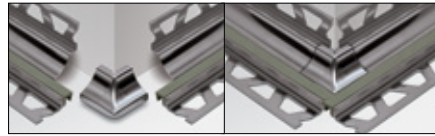

Inside corner, 3-way (90°)

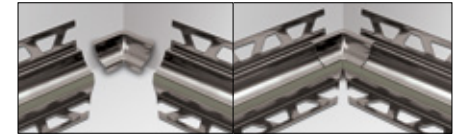

Connector

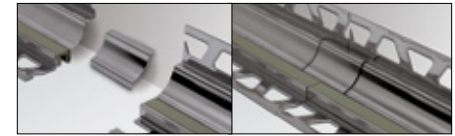
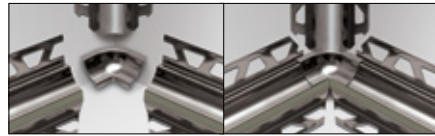

End cap

***Color Codes**



* To complete the item number, add the **color** code (e.g., HKS V2A U 18 / O 7 **G**).

U: 8 mm = 5/16"	10 mm = 3/8"	12 mm = 15/32"	14 mm = 17/32"	16 mm = 5/8"
18 mm = 23/32"	21 mm = 13/16"	25 mm = 1"	30 mm = 1-3/16"	
O: 7 mm = 9/32"	9 mm = 11/32"	11 mm = 7/16"		

Schluter®-DILEX-HKS	
Length = 2.5 m - 8' 2-1/2"	Stainless steel 304 (1.4301 = V2A) (E)
U = floor or wall, O = wall	
Profile	\$ / Length
HKS V2A U 8 / O 7 + color*	143.49
HKS V2A U 10 / O 7 + color*	144.92
HKS V2A U 12 / O 7 + color*	145.59
HKS V2A U 14 / O 7 + color*	147.71
HKS V2A U 16 / O 7 + color*	149.14
HKS V2A U 18 / O 7 + color*	149.85
HKS V2A U 21 / O 7 + color*	151.24
HKS V2A U 25 / O 7 + color*	154.04
HKS V2A U 30 / O 7 + color*	156.15
HKS V2A U 8 / O 9 + color*	143.49
HKS V2A U 10 / O 9 + color*	144.92
HKS V2A U 12 / O 9 + color*	145.59
HKS V2A U 14 / O 9 + color*	147.71
HKS V2A U 16 / O 9 + color*	149.14
HKS V2A U 18 / O 9 + color*	149.85
HKS V2A U 21 / O 9 + color*	151.24
HKS V2A U 25 / O 9 + color*	154.04
HKS V2A U 30 / O 9 + color*	156.15
HKS V2A U 8 / O 11 + color*	143.49
HKS V2A U 10 / O 11 + color*	144.92
HKS V2A U 12 / O 11 + color*	145.59
HKS V2A U 14 / O 11 + color*	147.71
HKS V2A U 16 / O 11 + color*	149.14
HKS V2A U 18 / O 11 + color*	149.85
HKS V2A U 21 / O 11 + color*	151.24
HKS V2A U 25 / O 11 + color*	154.04
HKS V2A U 30 / O 11 + color*	156.15

Schluter®-DILEX-HKS		
Stainless steel 316L (1.4404 = V4A) (EV4A)		\$ / Unit
Outside corner, 90°	A/EHK 2 R18	9.58
Inside corner, 90° (2-way)	I/EHK 2 R18	9.58
Inside corner, 90° (3-way)	I/EHK 3 R18	9.58
Outside corner, 135°	E135/EHK2R18	9.58
Inside corner, 135°	I135/EHK2R18	9.58
Connector	V/EHK	9.58
End cap	E/HKW/G (Grey PVC only)	4.99

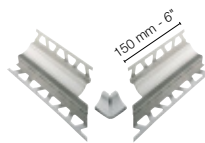

Note: 90° outside corners with pre-cut profile sections are available by special order only. Please contact Customer Service for availability.

Schluter®-DILEX-HKS		
Stainless steel 304 (1.4301 = V2A) (E)		\$ / Unit
90° outside corner with pre-cut profile sections	E90 V2A U ... / O ... + color**	56.62
Stainless steel 316L (1.4404 = V4A) (EV4A)		\$ / Unit
90° outside corner with pre-cut profile sections	E90 V4A U ... / O ... + color**	62.90

** To complete the item number, add the "U" and "O" values, and the **color** code (e.g., E90 V2A U 12 / O 9 **G**). Available for U = 8, 10, 12, 14 and 16 mm only.

Schluter®-DILEX-HKU

Schluter®-DILEX-HKU is a stainless steel, cove-shaped profile for inside wall corners and floor/wall (including countertop/backsplash) transitions. DILEX-HKU may be used with floor coverings other than ceramic and stone tile, provided the floor coverings are fastened or adhered (i.e., no floating floors). The profile features a single anchoring leg that turns inward, which allows it to be used with different thicknesses of tile. DILEX-HKU is available with either a 3/8" (10 mm) or 1-7/16" (36 mm) radius cove section. The cove section forms the visible surface and prevents the accumulation of dirt, making cleaning simple. DILEX-HKU prevents surface water penetration and meets the maintenance and hygienic requirements of commercial kitchens, bathrooms, and food processing plants, or any tiled environment where a sanitary cove base is desired.

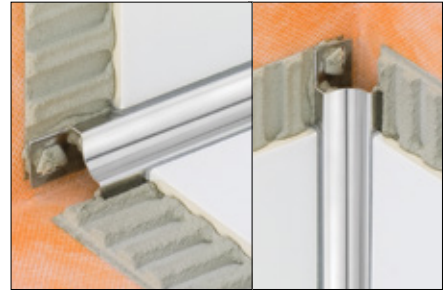
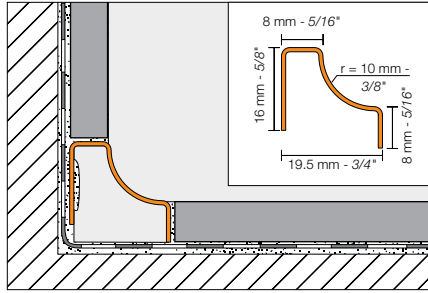

Outside corner (90° or 135°)

Inside corner (90° or 135°)

Connector

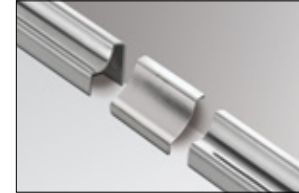
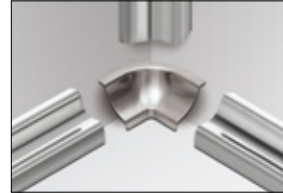
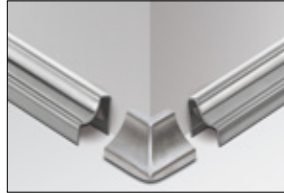

Schluter®-DILEX-HKU (10 mm - 3/8" radius)

Length = 2.5 m - 8' 2-1/2"	Stainless steel 304 (1.4301 = V2A) (E)		Stainless steel 316L (1.4404 = V4A) (EV4A)					
	Profile	\$ / Length	Outside corner 90°	Inside corner 90°	\$ / Unit	Outside corner 135°	Inside corner 135°	\$ / Unit
R = mm - in.								
10 - 3/8	HKUR 10 E	57.28	EQ/HKUR 10 E	I/HKU 3 R 10 E	6.52	E135/HKUR 10 E	I135/HKUR 10 E	6.22
Connector	V/HKUR 10 E							5.92
End cap	EK/HKUR 10 E							5.40

Length = 2.5 m - 8' 2-1/2"	Stainless steel 316L (1.4404 = V4A) (EV4A)							
	Profile	\$ / Length	Outside corner 90°	Inside corner 90°	\$ / Unit	Outside corner 135°	Inside corner 135°	\$ / Unit
R = mm - in.								
10 - 3/8	HKUR 10 E / V4A	85.85	EQ/HKUR 10 E	I/HKU 3 R 10 E	6.52	E135/HKUR 10 E	I135/HKUR 10 E	6.22
Connector	V/HKUR 10 E							5.92
End cap	EK/HKUR 10 E							5.40

Length = 2.5 m - 8' 2-1/2"	Brushed stainless steel 304 (1.4301 = V2A) (EB)		Brushed stainless steel 316L (1.4404 = V4A) (EBV4A)					
	Profile	\$ / Length	Outside corner 90°	Inside corner 90°	\$ / Unit	Outside corner 135°	Inside corner 135°	\$ / Unit
R = mm - in.								
10 - 3/8	HKUR 10 EB	62.73	EQ/HKUR 10 EB	I/HKU 3 R 10 EB	6.52	E135/HKUR 10 EB	I135/HKUR 10 EB	6.22
Connector	V/HKUR 10 EB							5.92
End cap	EK/HKUR 10 EB							5.40

Schluter®-DILEX-HKU (36 mm - 1-7/16" radius)

Length = 2.5 m - 8' 2-1/2"	Stainless steel 304 (1.4301 = V2A) (E)				
	Profile	\$ / Length	Outside corner 90°	Inside corner 90°*	\$ / Unit
R = mm - in.					
36 - 1-7/16	HKUR 36 E	93.84	E/HKUR 36 E	I/HKU 3 R 36 10 E	11.39
External connector, stainless steel	V/HKUR 36 E				11.39
Internal connector, EPS foam	V/HKUR 36				3.22
End cap	EK/HKUR 36 E (grey PVC only)				8.58

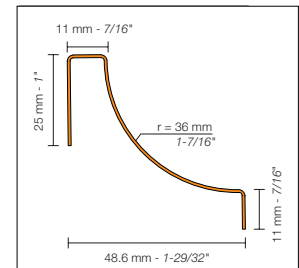

*For 3-way inside corners, use the Schluter®-DILEX-EHK profile on the vertical (page 92).

Internal connector, EPS foam

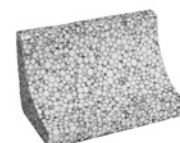



Schluter®-VINPRO

Profiles designed for resilient surface coverings (LVT)

Luxury vinyl and other resilient flooring materials have improved and evolved into a whole new generation of vinyl floor coverings. Mimicking the natural looks of wood and stone using high-fidelity printing, the product is durable and realistic in both finish and texture. Following trends or creating custom layouts, resilient coverings are not limited to floors and can offer a fresh design and additional warmth to walls in a residential or commercial environment.

VINPRO is a series of finishing, edge-protection and transition profiles designed for luxury vinyl and other resilient coverings, for floors, walls, and stair surfaces.



VINPRO-STEP-R in brushed antique bronze
(page 99)



Schluter®-VINPRO-S

Schluter®-VINPRO-S is designed to provide edging for resilient coverings (e.g., LVT). Typical applications include edge protection where the resilient covering is bordered by carpet, floor coverings of similar heights, or as a finishing edge to wall skirting applications. The profile features a 1/4" (6 mm) or 7/16" (11 mm) wide sloped top flange to hide the cut edge of the resilient floor covering, providing a finished look.

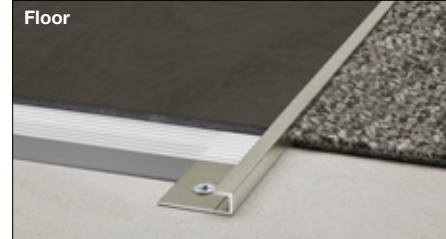
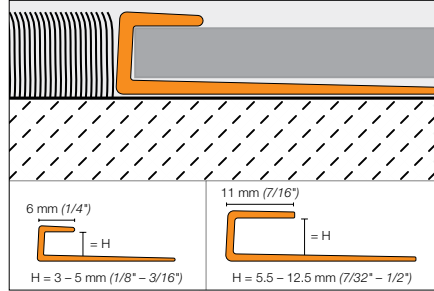

Schluter®-VINPRO-S							
Length = 2.5 m - 8' 2-1/2"	Brushed chrome anod. alu. (ACGB)		Brushed nickel anod. alu. (ATGB)		Brushed antique bronze anod. alu. (ABGB)		
H = mm - in.	Item No.	\$ / Length	Item No.	\$ / Length	Item No.	\$ / Length	
3 - 1/8	VPS 30 ACGB	16.90	VPS 30 ATGB	18.05	VPS 30 ABGB	18.89	
4 - 5/32	VPS 40 ACGB	17.11	VPS 40 ATGB	18.27	VPS 40 ABGB	19.17	
5 - 3/16	VPS 50 ACGB	17.27	VPS 50 ATGB	18.44	VPS 50 ABGB	19.31	
5.5 - 7/32	VPSL 55 ACGB	22.03	VPSL 55 ATGB	23.10	VPSL 55 ABGB	23.92	
6 - 1/4	VPSL 60 ACGB	22.26	VPSL 60 ATGB	23.35	VPSL 60 ABGB	24.15	
6.5 - 17/64	VPSL 65 ACGB	22.48	VPSL 65 ATGB	23.57	VPSL 65 ABGB	24.40	
7 - 9/32	VPSL 70 ACGB	22.71	VPSL 70 ATGB	23.82	VPSL 70 ABGB	24.64	
7.5 - 19/64	VPSL 75 ACGB	22.93	VPSL 75 ATGB	24.05	VPSL 75 ABGB	24.90	
8 - 5/16	VPSL 80 ACGB	23.14	VPSL 80 ATGB	24.30	VPSL 80 ABGB	25.13	
8.5 - 21/64	VPSL 85 ACGB	23.39	VPSL 85 ATGB	24.53	VPSL 85 ABGB	25.40	
9 - 11/32	VPSL 90 ACGB	23.61	VPSL 90 ATGB	24.77	VPSL 90 ABGB	25.64	
10 - 3/8	VPSL 100 ACGB	23.86	VPSL 100 ATGB	25.03	VPSL 100 ABGB	25.91	
11 - 7/16	VPSL 110 ACGB	24.10	VPSL 110 ATGB	25.27	VPSL 110 ABGB	26.16	
12.5 - 1/2	VPSL 125 ACGB	24.34	VPSL 125 ATGB	25.53	VPSL 125 ABGB	26.43	

Schluter®-VINPRO-T

Schluter®-VINPRO-T is designed to provide transitions between same-height resilient floor coverings, (e.g., LVT) primarily in retrofit applications.

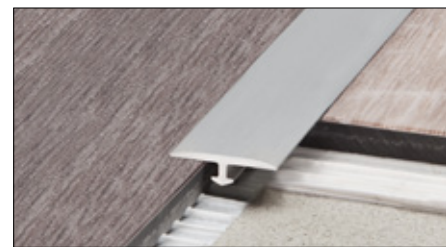
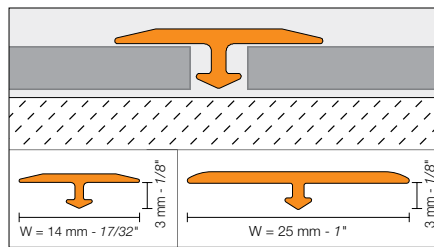

Schluter®-VINPRO-T							
Length = 2.5 m - 8' 2-1/2"	Brushed chrome anod. alu. (ACGB)		Brushed nickel anod. alu. (ATGB)		Brushed antique bronze anod. alu. (ABGB)		
W = mm - in.	Item No.	\$ / Length	Item No.	\$ / Length	Item No.	\$ / Length	
14 - 17/32	VPT 3/14 ACGB	14.24	VPT 3/14 ATGB	14.24	VPT 3/14 ABGB	14.24	
25 - 1	VPTL 3/25 ACGB	18.13	VPTL 3/25 ATGB	18.13	VPTL 3/25 ABGB	18.13	



Schluter®-VINPRO-U

Schluter®-VINPRO-U is designed to provide a smooth transition between resilient floor coverings (e.g. LVT) and floor coverings at lower elevations or finished concrete. The profile features a 1/4" (6 mm) or 7/16" (11 mm) wide sloped top flange to hide the cut edge of the resilient floor covering, providing a finished look.

ADA-Compliant

In installations where the leading edge abuts a lower surface covering, all sizes of VINPRO-U are compliant with the Americans with Disabilities Act (ADA). In installations where the leading edge rests on top of the lower floor covering (e.g., finished concrete), the 7/16" (11 mm) and 1/2" (12.5 mm) sizes are not ADA-compliant.

Technical Note: ADA requirements regarding transitions between surfaces of different heights:

- Up to 6 mm (1/4") - no special requirements
- 6 mm (1/4") to 12.5 mm (1/2") - slope ratio, 1:2
- More than 12.5 mm (1/2") - slope ratio, 1:12

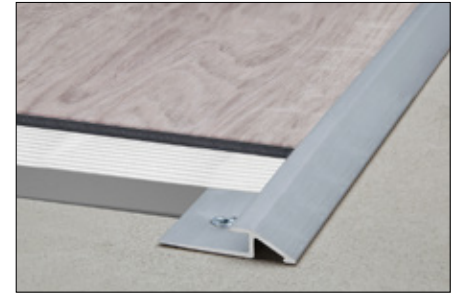
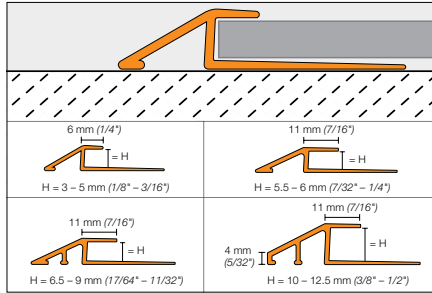
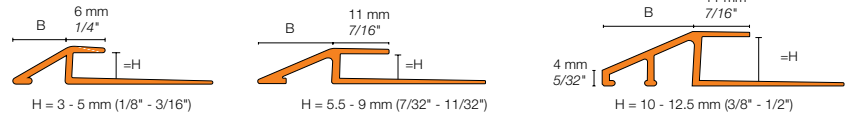

Diagram Values



H = mm - in		B = mm - in	
3	- 1/8	8	- 5/16
4	- 5/32	9.5	- 3/8
5	- 3/16	11.5	- 29/64
5.5	- 7/32	15.4	- 19/32
6	- 1/4	16.5	- 21/32
6.5	- 17/64	17.5	- 11/16
7	- 9/32	18.6	- 47/64
7.5	- 19/64	19.7	- 25/32
8	- 5/16	20.8	- 13/16
8.5	- 21/64	21.8	- 55/64
9	- 11/32	22.9	- 29/32
10	- 3/8	19.2	- 49/64
11	- 7/16	21.5	- 27/32
12.5	- 1/2	24.7	- 31/32

Schluter®-VINPRO-U

Length = 2.5 m - 8' 2-1/2"	Brushed chrome anod. alu. (ACGB)		Brushed nickel anod. alu. (ATGB)		Brushed antique bronze anod. alu. (ABGB)	
	Item No.	\$ / Length	Item No.	\$ / Length	Item No.	\$ / Length
H = 3 - 1/8	VPU 30 ACGB	19.45	VPU 30 ATGB	20.77	VPU 30 ABGB	21.72
4 - 5/32	VPU 40 ACGB	19.81	VPU 40 ATGB	21.12	VPU 40 ABGB	22.19
5 - 3/16	VPU 50 ACGB	20.53	VPU 50 ATGB	21.83	VPU 50 ABGB	22.90
5.5 - 7/32	VPUL 55 ACGB	31.67	VPUL 55 ATGB	34.02	VPUL 55 ABGB	34.84
6 - 1/4	VPUL 60 ACGB	32.62	VPUL 60 ATGB	35.05	VPUL 60 ABGB	35.89
6.5 - 17/64	VPUL 65 ACGB	33.60	VPUL 65 ATGB	36.09	VPUL 65 ABGB	36.96
7 - 9/32	VPUL 70 ACGB	34.61	VPUL 70 ATGB	37.18	VPUL 70 ABGB	38.08
7.5 - 19/64	VPUL 75 ACGB	35.65	VPUL 75 ATGB	38.29	VPUL 75 ABGB	39.23
8 - 5/16	VPUL 80 ACGB	36.72	VPUL 80 ATGB	39.43	VPUL 80 ABGB	40.41
8.5 - 21/64	VPUL 85 ACGB	37.81	VPUL 85 ATGB	40.62	VPUL 85 ABGB	41.62
9 - 11/32	VPUL 90 ACGB	38.95	VPUL 90 ATGB	41.83	VPUL 90 ABGB	42.85
10 - 3/8	VPUL 100 ACGB	42.47	VPUL 100 ATGB	48.63	VPUL 100 ABGB	53.46
11 - 7/16	VPUL 110 ACGB	43.74	VPUL 110 ATGB	50.10	VPUL 110 ABGB	55.06
12.5 - 1/2	VPUL 125 ACGB	45.06	VPUL 125 ATGB	51.60	VPUL 125 ABGB	56.71



Schluter®-VINPRO-RO

Schluter®-VINPRO-RO is a finishing and edging profile for resilient covering (e.g., LVT) installations on stairs and outside corners of resilient surfaces. The reveal of the profile forms a symmetrically rounded corner along the surface edge.

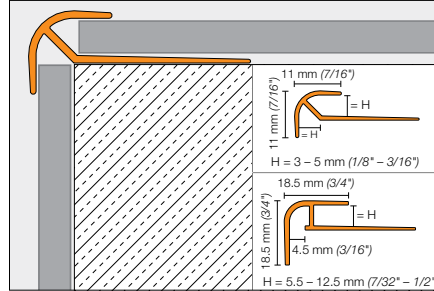

Schluter®-VINPRO-RO

Length = 2.5 m - 8' 2-1/2"	Brushed chrome anod. alu. (ACGB)		Brushed nickel anod. alu. (ATGB)		Brushed antique bronze anod. alu. (ABGB)	
H = mm - in.	Item No.	\$ / Length	Item No.	\$ / Length	Item No.	\$ / Length
3 - 1/8	VPRO 30 ACGB	24.50	VPRO 30 ATGB	26.09	VPRO 30 ABGB	27.29
4 - 5/32	VPRO 40 ACGB	24.80	VPRO 40 ATGB	26.40	VPRO 40 ABGB	27.59
5 - 3/16	VPRO 50 ACGB	25.27	VPRO 50 ATGB	26.87	VPRO 50 ABGB	28.06
5.5 - 7/32	VPROL 55 ACGB	33.80	VPROL 55 ATGB	35.14	VPROL 55 ABGB	35.48
6 - 1/4	VPROL 60 ACGB	34.15	VPROL 60 ATGB	35.50	VPROL 60 ABGB	35.82
6.5 - 17/64	VPROL 65 ACGB	34.49	VPROL 65 ATGB	35.84	VPROL 65 ABGB	36.18
7 - 9/32	VPROL 70 ACGB	34.82	VPROL 70 ATGB	36.21	VPROL 70 ABGB	36.54
7.5 - 19/64	VPROL 75 ACGB	35.18	VPROL 75 ATGB	36.57	VPROL 75 ABGB	36.90
8 - 5/16	VPROL 80 ACGB	35.54	VPROL 80 ATGB	36.92	VPROL 80 ABGB	37.27
8.5 - 21/64	VPROL 85 ACGB	35.88	VPROL 85 ATGB	37.30	VPROL 85 ABGB	37.65
9 - 11/32	VPROL 90 ACGB	36.25	VPROL 90 ATGB	37.68	VPROL 90 ABGB	38.02
10 - 3/8	VPROL 100 ACGB	36.62	VPROL 100 ATGB	38.05	VPROL 100 ABGB	38.40
11 - 7/16	VPROL 110 ACGB	36.96	VPROL 110 ATGB	38.43	VPROL 110 ABGB	38.79
12.5 - 1/2	VPROL 125 ACGB	37.34	VPROL 125 ATGB	38.82	VPROL 125 ABGB	39.17



Schluter®-VINPRO-STEP

Schluter®-VINPRO-STEP is a finishing and edging profile for resilient floor covering (e.g. LVT) installations on stairs. Two versions are available: the 1/8"-3/16" (3-5 mm) version featuring a 1/4" (6 mm) wide top flange that is grooved to add slip resistance to the horizontal surface, and the 7/32" (5.5 mm) and larger versions that feature a 7/16" (11 mm) wide top flange with a smooth horizontal surface finish. The vertical leg covers the edge of the subassembly and top of the riser.

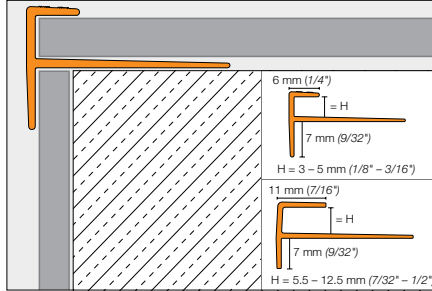

Schluter®-VINPRO-STEP						
Length = 2.5 m - 8' 2-1/2"	Brushed chrome anod. alu. (ACGB)		Brushed nickel anod. alu. (ATGB)		Brushed antique bronze anod. alu. (ABGB)	
H = mm - in.	Item No.	\$/ Length	Item No.	\$/ Length	Item No.	\$/ Length
3 - 1/8	VPST 30 ACGB	23.85	VPST 30 ATGB	25.51	VPST 30 ABGB	25.51
4 - 5/32	VPST 40 ACGB	24.02	VPST 40 ATGB	25.74	VPST 40 ABGB	25.74
5 - 3/16	VPST 50 ACGB	24.25	VPST 50 ATGB	25.98	VPST 50 ABGB	25.98
5.5 - 7/32	VPSTL 55 ACGB	27.35	VPSTL 55 ATGB	28.90	VPSTL 55 ABGB	31.03
6 - 1/4	VPSTL 60 ACGB	28.17	VPSTL 60 ATGB	29.76	VPSTL 60 ABGB	31.96
6.5 - 17/64	VPSTL 65 ACGB	29.01	VPSTL 65 ATGB	30.66	VPSTL 65 ABGB	32.93
7 - 9/32	VPSTL 70 ACGB	29.89	VPSTL 70 ATGB	31.58	VPSTL 70 ABGB	33.92
7.5 - 19/64	VPSTL 75 ACGB	30.79	VPSTL 75 ATGB	32.53	VPSTL 75 ABGB	34.94
8 - 5/16	VPSTL 80 ACGB	31.71	VPSTL 80 ATGB	33.51	VPSTL 80 ABGB	35.97
8.5 - 21/64	VPSTL 85 ACGB	32.66	VPSTL 85 ATGB	34.52	VPSTL 85 ABGB	37.07
9 - 11/32	VPSTL 90 ACGB	33.64	VPSTL 90 ATGB	35.55	VPSTL 90 ABGB	38.17
10 - 3/8	VPSTL 100 ACGB	34.65	VPSTL 100 ATGB	36.62	VPSTL 100 ABGB	39.31
11 - 7/16	VPSTL 110 ACGB	35.69	VPSTL 110 ATGB	37.71	VPSTL 110 ABGB	40.49
12.5 - 1/2	VPSTL 125 ACGB	36.76	VPSTL 125 ATGB	38.84	VPSTL 125 ABGB	41.71

Schluter®-VINPRO-STEP-R

Schluter®-VINPRO-STEP-R is a finishing and edging profile for resilient covering (e.g., LVT) installations on stairs. The top of the profile features a capping flange with a rounded leading edge, while the elongated vertical section provides increased visibility.

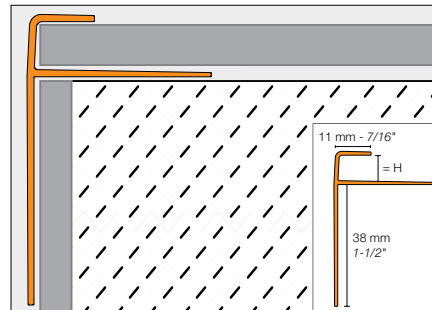

Schluter®-VINPRO-STEP-R						
Length = 2.5 m - 8' 2-1/2"	Brushed chrome anod. alu. (ACGB)		Brushed nickel anod. alu. (ATGB)		Brushed antique bronze anod. alu. (ABGB)	
H = mm - in.	Item No.	\$/ Length	Item No.	\$/ Length	Item No.	\$/ Length
3 - 1/8	VPSTRL 30 ACGB	44.43	VPSTRL 30 ATGB	48.17	VPSTRL 30 ABGB	48.24
4 - 5/32	VPSTRL 40 ACGB	44.88	VPSTRL 40 ATGB	48.65	VPSTRL 40 ABGB	48.73
5 - 3/16	VPSTRL 50 ACGB	45.33	VPSTRL 50 ATGB	49.15	VPSTRL 50 ABGB	49.22
5.5 - 7/32	VPSTRL 55 ACGB	45.78	VPSTRL 55 ATGB	49.64	VPSTRL 55 ABGB	49.70
6 - 1/4	VPSTRL 60 ACGB	46.25	VPSTRL 60 ATGB	50.13	VPSTRL 60 ABGB	50.20
6.5 - 17/64	VPSTRL 65 ACGB	46.72	VPSTRL 65 ATGB	50.63	VPSTRL 65 ABGB	50.70
7 - 9/32	VPSTRL 70 ACGB	47.16	VPSTRL 70 ATGB	51.14	VPSTRL 70 ABGB	51.20
7.5 - 19/64	VPSTRL 75 ACGB	47.64	VPSTRL 75 ATGB	51.66	VPSTRL 75 ABGB	51.72
8 - 5/16	VPSTRL 80 ACGB	48.11	VPSTRL 80 ATGB	52.17	VPSTRL 80 ABGB	52.24
8.5 - 21/64	VPSTRL 85 ACGB	48.59	VPSTRL 85 ATGB	52.69	VPSTRL 85 ABGB	52.76
9 - 11/32	VPSTRL 90 ACGB	49.08	VPSTRL 90 ATGB	53.22	VPSTRL 90 ABGB	53.28
10 - 3/8	VPSTRL 100 ACGB	49.58	VPSTRL 100 ATGB	53.76	VPSTRL 100 ABGB	53.83
11 - 7/16	VPSTRL 110 ACGB	50.07	VPSTRL 110 ATGB	54.29	VPSTRL 110 ABGB	54.37
12.5 - 1/2	VPSTRL 125 ACGB	50.57	VPSTRL 125 ATGB	54.84	VPSTRL 125 ABGB	54.91



Schluter®-KERDI-BOARD

Waterproof, tile-ready substrates & building panels

Whether you work with mosaics or large-format tiles, an absolutely flat substrate with straight and precisely aligned inside and outside corners is essential for creating a perfect tile covering, which tile installers can now achieve on their own using KERDI-BOARD.

KERDI-BOARD gives tile setters control over their projects by providing them with the means to simply and easily create ideal substrates for tile. Unsuitable substrates can be remedied and new substrates can be produced while keeping the technical and aesthetic requirements of the tile covering in mind.





Schluter®-KERDI-BOARD

Schluter®-KERDI-BOARD is a multifunctional tile substrate and building panel, which can also be used for creating bonded waterproofing assemblies with tile coverings. It consists of an extruded polystyrene foam panel, with a special reinforcement material on both sides and fleece webbing for effective anchoring in thin-set mortar.

With the available panel thicknesses of 3/16", 3/8", 1/2", 5/8", 3/4", 1", 1-1/2", and 2" (5, 9, 12.5, 15, 19, 25, 38, and 50 mm), KERDI-BOARD allows the installer to prepare and create a broad range of substrates and building elements for the installation of ceramic and natural stone tile that are flat, level, plumb, square, and dimensionally stable. With suitable preparation of the abutting seams and joint areas, the panel may be used for bonded waterproofing assemblies.

The boards are simply cut to size with a utility knife. The gridlines, which are printed on the surface, are helpful for neat and quick cuts and installation. Tiles can be installed directly over KERDI-BOARD using the thin-set method.

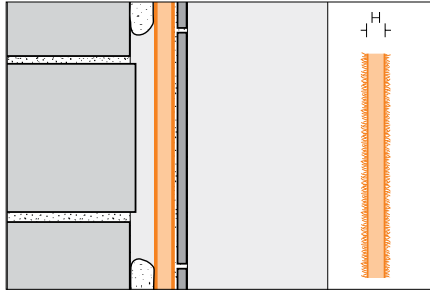

KERDI-BOARD By Pallet

The KERDI-BOARD panels listed in the table below are shipped in full pallets only. Please order in multiples of the pallet quantity.

Schluter®-KERDI-BOARD				
Substrate and building panel				
H = mm - in.	Item No.	\$ / Panel	Panels / Pallet	\$ / Pallet
Panel dimension: 122 cm x 81 cm – 48" x 32"				
12.5 - 1/2	KB 12 1220 812	45.06	144	6,488.64
Panel dimension: 122 cm x 162.5 cm – 48" x 64"				
12.5 - 1/2	KB 12 1220 1625	90.15	80	7,212.00
Panel dimension: 122 cm x 244 cm – 48" x 96"				
12.5 - 1/2	KB 12 1220 2440	135.19	80	10,815.20
15 - 5/8	KB 15 1220 2440	152.86	65	9,935.90
Panel dimension: 122 cm x 305 cm – 48" x 120"				
15 - 5/8	KB 15 1220 3050*	191.06	65	12,418.90

* KERDI-BOARD 5/8" panels in 48" x 120" format are available by special order only. Please contact Customer Service for more information.

KERDI-BOARD By Bundle

The KERDI-BOARD panels listed in the table below are shipped in bundles only. Please order in multiples of the bundle quantity.

Schluter®-KERDI-BOARD				
Substrate and building panel				
H = mm - in.	Item No.	\$ / Panel	Panels / Bundle	\$ / Bundle
Panel dimension: 122 cm x 162.5 cm – 48" x 64"				
5 - 3/16	KB 5 1220 1625	82.11	10	821.10
9 - 3/8	KB 9 1220 1625	86.13	8	689.04
Panel dimension: 122 cm x 244 cm – 48" x 96"				
5 - 3/16	KB 5 1220 2440	123.11	6	738.66
9 - 3/8	KB 9 1220 2440	129.16	5	645.80
Panel dimension: 62.5 cm x 244 cm – 24-1/2" x 96"				
19 - 3/4	KB 19 625 2440	73.92	6	443.52
25 - 1	KB 25 625 2440	78.51	4	314.04
38 - 1-1/2	KB 38 625 2440	89.95	3	269.85
50 - 2	KB 50 625 2440	101.05	3	303.15

⚠ WARNING: Cancer and Reproductive Harm - www.P65Warnings.ca.gov

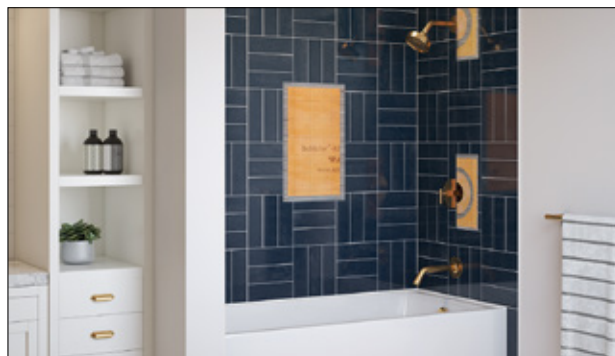

Schluter®-KERDI-BOARD-KIT

Complete kit for waterproofing walls around bathtubs and acrylic shower bases. Refer to page 172.





Schluter®-KERDI-BOARD-V

Schluter®-KERDI-BOARD-V is a vertically grooved substrate and building panel for creating curved elements. If a larger expanse of panels is required, several panels can be connected along the edges with thin-set mortar, Schluter®-KERDI-FIX adhesive, or double-sided adhesive tape.

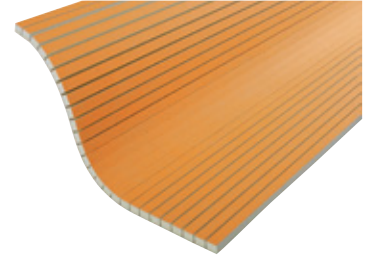
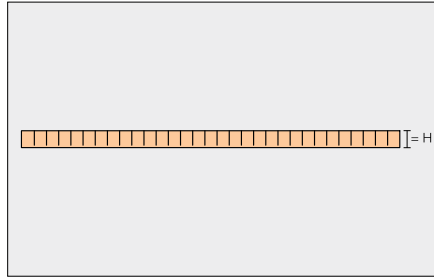

WARNING: Cancer and Reproductive Harm - www.P65Warnings.ca.gov

Schluter®-KERDI-BOARD-V				
Grooved substrate and building panel				
H = mm - in.	Item No.	\$ / Panel	Panels / Bundle	\$ / Bundle
Panel dimension: 62.5 cm x 244 cm – 24-1/2" x 96"				
19 - 3/4	KB 19 625 2440 V	89.83	6	538.98
25 - 1	KB 25 625 2440 V	97.84	4	391.36
38 - 1-1/2	KB 38 625 2440 V	107.72	3	323.16
50 - 2	KB 50 625 2440 V	118.80	3	356.40

Schluter®-KERDI-BOARD-E

Schluter®-KERDI-BOARD-E is an L-shaped panel used to create corners and pipe or column coverings.

The panels feature a V-shaped groove and are shipped in a space-saving flat design, which makes them easy to store. The flat panels are also quick to cut to the necessary dimensions. Thin-set mortar, Schluter®-KERDI-FIX adhesive, or double-sided adhesive tape is applied to the V-groove. The panels are then folded prior to installation.

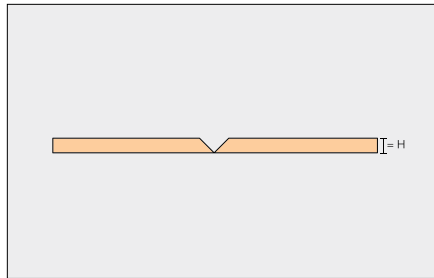

WARNING: Cancer and Reproductive Harm - www.P65Warnings.ca.gov

Schluter®-KERDI-BOARD-E				
L-shaped panel				
H = mm - in.	Item No.	\$ / Panel	Panels / Bundle	\$ / Bundle
Panel dimension: 62.5 cm x 244 cm – 24-1/2" x 96"				
19 - 3/4	KB 19 625 2440 E	96.90	6	581.40
25 - 1	KB 25 625 2440 E	102.88	4	411.52

Schluter®-KERDI-BOARD-U

Schluter®-KERDI-BOARD-U is a U-shaped panel used to create pipe or column coverings.

The panels feature V-shaped grooves and are shipped in a space-saving flat design, which makes them easy to store. The flat panels are also quick to cut to the necessary dimensions. Thin-set mortar, Schluter®-KERDI-FIX adhesive, or double-sided adhesive tape is applied to the V-grooves. The panels are then folded prior to installation.

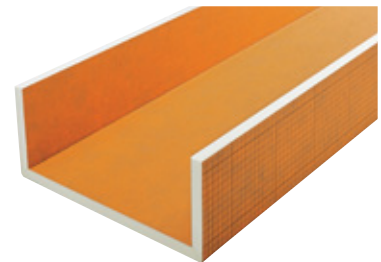
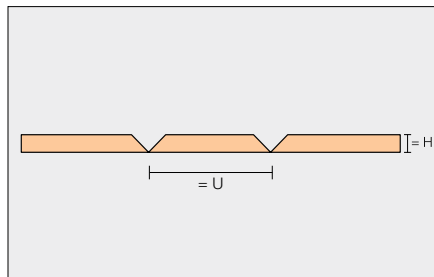

WARNING: Cancer and Reproductive Harm - www.P65Warnings.ca.gov

Schluter®-KERDI-BOARD-U				
U-shaped panel				
H = mm - in.	Item No.	\$ / Panel	Panels / Bundle	\$ / Bundle
Panel dimension: 62.5 cm x 244 cm – 24-1/2" x 96"				
U = 20 cm – 7-7/8"				
19 - 3/4	KB 19 625 2440 U 20	121.64	6	729.84
U = 30 cm – 11-13/16"				
19 - 3/4	KB 19 625 2440 U 30	121.64	6	729.84



Schluter®-KERDI-BOARD-SC

Schluter®-KERDI-BOARD-SC is a prefabricated shower curb made of KERDI-BOARD that is designed to integrate with the Schluter®-Shower System. The curb is lightweight, stable, and load bearing. It can be used in conjunction with the KERDI-SHOWER prefabricated shower trays as well as in mortar bed applications. KERDI-BOARD-SC is quick and easy to install, waterproof and ready to tile, making it a simple solution for tiled shower curbs.

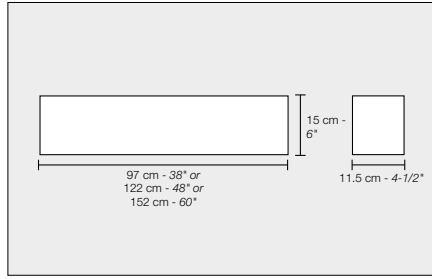

Schluter®-KERDI-BOARD-SC				
Curb				
Item No.	Length	Width	Height	\$ / Unit
KBSC 115 150 970	97 cm - 38"	11.5 cm - 4-1/2"	15 cm - 6"	67.17
KBSC 115 150 1220	122 cm - 48"	11.5 cm - 4-1/2"	15 cm - 6"	73.27
KBSC 115 150 1524	152 cm - 60"	11.5 cm - 4-1/2"	15 cm - 6"	107.46

⚠ WARNING: Cancer and Reproductive Harm - www.P65Warnings.ca.gov

Schluter®-KERDI-BOARD-SB

Schluter®-KERDI-BOARD-SB is a prefabricated shower bench made of KERDI-BOARD that is designed to integrate with the Schluter®-Shower System. The bench is lightweight, stable, and load bearing. It features a sloped surface to prevent the accumulation of water. KERDI-BOARD-SB is quick and easy to install, waterproof and ready to tile, making it a simple solution for tiled shower benches.

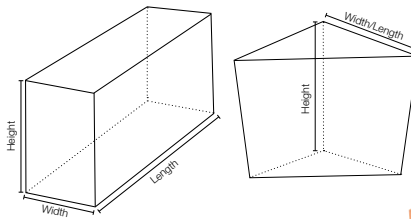

Includes 2 inside and 2 outside KERDI-KERECK waterproofing corners.

Schluter®-KERDI-BOARD-SB					
Bench					
Item No.	Length	Width	Height	Shape	\$ / Unit
KBSB 410 TA	41 cm - 16"	41 cm - 16"	51 cm - 20"	Triangular	185.61
KBSB 610 TA	61 cm - 24"	61 cm - 24"	51 cm - 20"	Triangular	241.79
KBSB 290 970 RA	97 cm - 38"	29 cm - 11-1/2"	51 cm - 20"	Rectangular	299.19
KBSB 410 1220 RA	122 cm - 48"	41 cm - 16"	51 cm - 20"	Rectangular	396.88





⚠ WARNING: Cancer and Reproductive Harm - www.P65Warnings.ca.gov

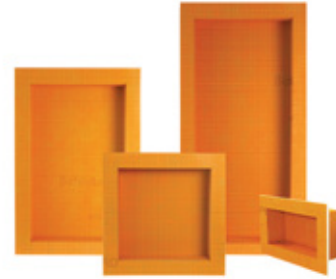
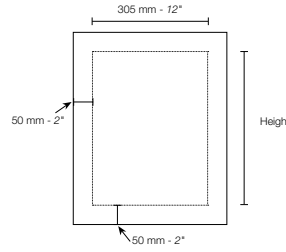

Schluter®-KERDI-BOARD-SN

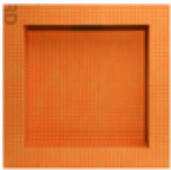
Schluter®-KERDI-BOARD-SN is a prefabricated shower niche made of Schluter®-KERDI-BOARD that can be installed in both Schluter®-KERDI and KERDI-BOARD wall assemblies. The shower niche features a 1/2" (12.5 mm) -thick by 2" (50 mm) -wide integrated bonding flange and is available in 4 different sizes.



Contents	
	
1x Niche	1x KERDI-BAND waterproofing frame
	8x KERDI-BOARD-ZS Screws
	8x KERDI-BOARD-ZT Washers

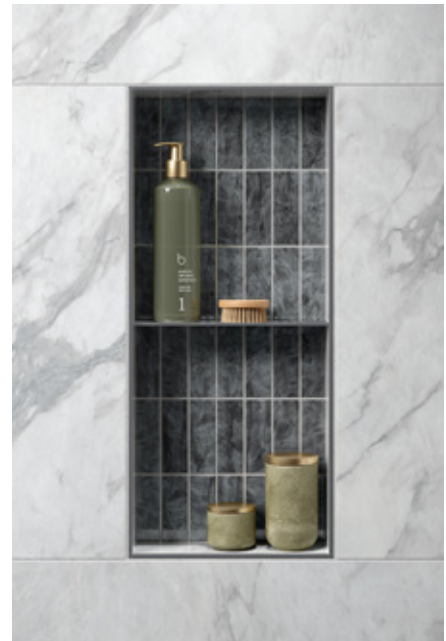

Schluter®-KERDI-BOARD-SN				
Niche				
Item No.	Height	Width	Depth	\$ / Unit
KB 12 SN 305 152 AF	152 mm - 6"	305 mm - 12"	89 mm - 3-1/2"	66.57
KB 12 SN 305 305 AF	305 mm - 12"	305 mm - 12"	89 mm - 3-1/2"	79.72
KB 12 SN 305 508 AF	508 mm - 20"	305 mm - 12"	89 mm - 3-1/2"	107.76
KB 12 SN 305 711 AF	711 mm - 28"	305 mm - 12"	89 mm - 3-1/2"	128.80

⚠ WARNING: Cancer and Reproductive Harm - www.P65Warnings.ca.gov



See your Shower
in a Whole New

Light

NEW! KERDI-BOARD-SNLT
Now available in horizontal format
(page 164)



Schluter®-KERDI-BOARD-ZC

Schluter®-KERDI-BOARD-ZC is a brushed stainless steel, U-shaped profile with one perforated anchoring leg. It is used to finish the edges of countertops, vanities, and similar structures in conjunction with the Schluter®-RONDEC or Schluter®-QUADEC finishing profiles.

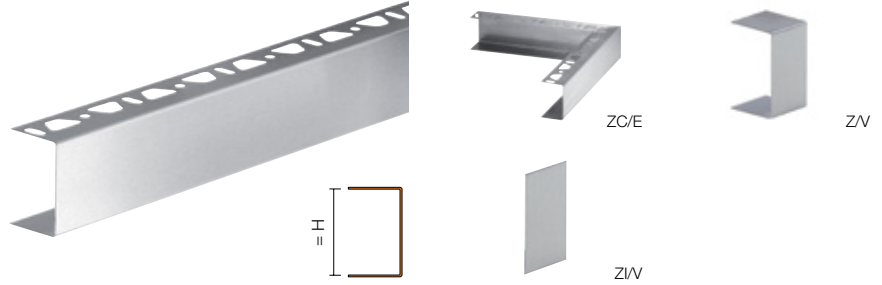

Schluter®-KERDI-BOARD-ZC		
U-shaped brushed stainless steel profile with 1 perforated anchoring leg		
H = mm - in.	Item No.	\$ / Length
Length = 2.50 m - 8' 2-1/2"		
38 - 1-1/2	KB ZC 38 EB	69.24
50 - 2	KB ZC 50 EB	75.65

Schluter®-KERDI-BOARD-ZC/E		
Brushed stainless steel outside corner piece for ZC		
H = mm - in.	Item No.	\$ / Unit
38 - 1-1/2	E/KB ZC 38 EB	24.96
50 - 2	E/KB ZC 50 EB	24.96

Schluter®-KERDI-BOARD-Z/V		
Brushed stainless steel connector for ZC and ZA		
H = mm - in.	Item No.	\$ / Unit
38 - 1-1/2	V/KB Z 38 EB	7.86
50 - 2	V/KB Z 50 EB	7.86

Schluter®-KERDI-BOARD-ZI/V		
Stainless steel internal connector for ZC and ZA		
H = mm - in.	Item No.	\$ / Unit
38 - 1-1/2	V/KB ZI 38 E	4.88
50 - 2	V/KB ZI 50 E	4.88

Schluter®-KERDI-BOARD-ZA

Schluter®-KERDI-BOARD-ZA is a brushed stainless steel, U-shaped profile with two perforated anchoring legs. It is used to finish visible edges of partition walls and shelves.

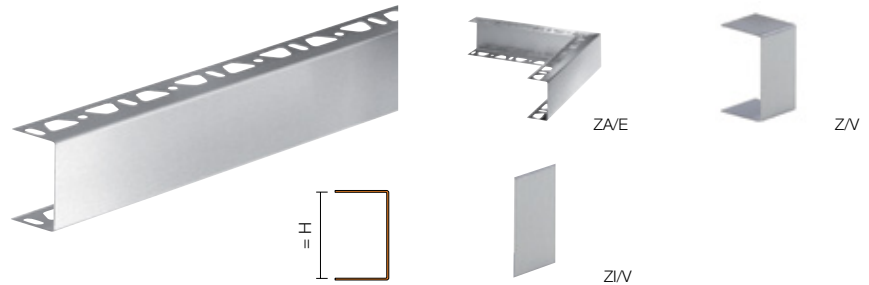

Schluter®-KERDI-BOARD-ZA		
U-shaped brushed stainless steel profile with 2 perforated anchoring legs		
H = mm - in.	Item No.	\$ / Length
Length = 2.50 m - 8' 2-1/2"		
19 - 3/4	KB ZA 19 EB	58.78
25 - 1	KB ZA 25 EB	63.47
38 - 1-1/2	KB ZA 38 EB	69.24
50 - 2	KB ZA 50 EB	75.65

Schluter®-KERDI-BOARD-ZA/E		
Brushed stainless steel outside corner piece for ZA		
H = mm - in.	Item No.	\$ / Unit
38 - 1-1/2	E/KB ZA 38 EB	24.96
50 - 2	E/KB ZA 50 EB	24.96

Schluter®-KERDI-BOARD-Z/V		
Brushed stainless steel connector for ZC and ZA		
H = mm - in.	Item No.	\$ / Unit
19 - 3/4	V/KB Z 19 EB	7.86
25 - 1	V/KB Z 25 EB	7.86
38 - 1-1/2	V/KB Z 38 EB	7.86
50 - 2	V/KB Z 50 EB	7.86

Schluter®-KERDI-BOARD-ZI/V		
Stainless steel internal connector for ZC and ZA		
H = mm - in.	Item No.	\$ / Unit
19 - 3/4	V/KB ZI 19 E	4.88
25 - 1	V/KB ZI 25 E	4.88
38 - 1-1/2	V/KB ZI 38 E	4.88
50 - 2	V/KB ZI 50 E	4.88



Schluter®-KERDI-BOARD-ZB

Schluter®-KERDI-BOARD-ZB is a stainless steel, U-shaped profile with three-sided perforation. It is used to fasten and stabilize partition walls and other structures made of KERDI-BOARD panels. The surfaces of the profile are hidden by the tile covering.

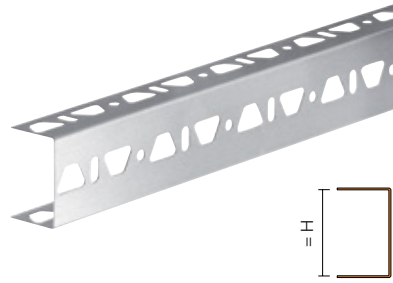

Schluter®-KERDI-BOARD-ZB		
U-shaped stainless steel profile with 3 perforated anchoring legs		
H = mm - in.	Item No.	\$ / Length
Length = 2.50 m - 8' 2-1/2"		
19 - 3/4	KB ZB 19 E	50.65
25 - 1	KB ZB 25 E	54.70
38 - 1-1/2	KB ZB 38 E	59.20
50 - 2	KB ZB 50 E	64.96

Schluter®-KERDI-BOARD-ZW

Schluter®-KERDI-BOARD-ZW is a stainless steel angle profile with two trapezoid perforated anchoring legs. It is used to fasten and stabilize structures made of KERDI-BOARD panels. It is attached to the substrate with either screws or thin-set mortar.

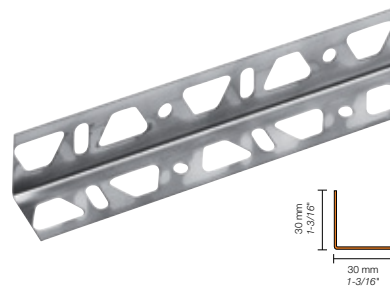

Schluter®-KERDI-BOARD-ZW	
Stainless steel angle profile	
Item No.	\$ / Length
Length = 15 cm - 6"	
KB ZW 30 E/15	1.97
Length = 2.50 m - 8' 2-1/2"	
KB ZW 30 E	29.28

Schluter®-KERDI-BOARD-ZSD

Schluter®-KERDI-BOARD-ZSD are anchors used to provide additional mechanical attachment of KERDI-BOARD when the bond between the thin-set mortar and the substrate is questionable.

Appropriate drill bit size: 8 mm - 5/16".
Drill hole 10 mm - 3/8" deeper than anchor length.

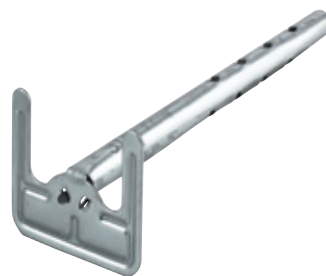

Schluter®-KERDI-BOARD-ZSD			
Stainless steel anchor			
Size = cm - in.	Item No.	Anchors / Box	\$ / Box
9 - 3-1/2	KB ZSD 90 E	25	33.77
11 - 4-5/16	KB ZSD 110 E	25	38.98
Galvanized steel anchor			
9 - 3-1/2	KB ZSD 90 Z	25	18.13
11 - 4-5/16	KB ZSD 110 Z	25	20.86



Schluter®-KERDI-BOARD-ZT/-ZS

Schluter®-KERDI-BOARD-ZT are galvanized steel washers used to fasten KERDI-BOARD to stud framing. They feature tabs that penetrate the surface of the KERDI-BOARD and temporarily hold the washers in place to enable quick installation of the corresponding screws.

Schluter®-KERDI-BOARD-ZS are screws used to fasten KERDI-BOARD to stud framing with the corresponding washers.

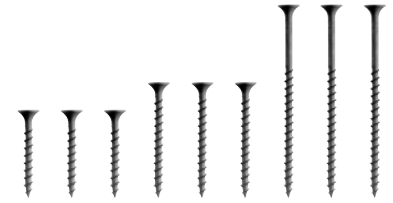

Schluter®-KERDI-BOARD-ZT			
Galvanized steel attachment washer			
Size = mm - in.	Item No.	Washers / Box	\$ / Box
32 - 1-1/4	KB ZT 32 Z	100	13.40
32 - 1-1/4	KB ZT 32 Z/L	1000	111.11

Schluter®-KERDI-BOARD-ZS			
Threaded screw for stud framing			
Size = mm - in.	Item No.	Screws / Box	\$ / Box
41 - 1-5/8	KB ZS 35 G	200	18.29
50 - 2	KB ZS 55 G	100	13.40
75 - 3	KB ZS 75 G	100	20.46



Convenient retail packaging.

Schluter®-KERDI-BOARD-ZT/-ZS			
Washer and Screw Set			
Size = mm - in.	Item No.	Pieces / Box	\$ / Box
41 - 1-5/8	KB ZS 35 GT 32 Z	40 each	15.24
41 - 1-5/8	KB ZS 35 GT 32 Z 100	100 each	28.76

Schluter®-KERDI-BOARD-ZFP

Schluter®-KERDI-BOARD-ZFP is a flat plastic profile, which is adhered behind the KERDI-BOARD-ZA U-shaped profile to improve fastening of hardware with screws.



Schluter®-KERDI-BOARD-ZFP		
Flat plastic profile		
Width mm - in.	Item No.	\$ / Length
Length = 2.50 m - 8' 2-1/2"		
35 - 1-3/8	KB ZFP 35	12.83



Schluter®-KERDI-BAND

Schluter®-KERDI-BAND is a waterproofing strip used to seal joints, corners, and fastener penetrations with the Schluter®-KERDI-BOARD building panels, as well as butt joints and floor/wall connections with the Schluter®-KERDI, DITRA, and DITRA-HEAT membranes.

Note: 1 mil = 1 one-thousandth of an inch

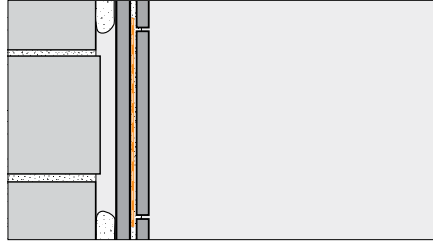

Schluter®-KERDI-BAND					
Waterproofing strip					
Item No.	Width	Length	Thickness	\$ / ft *	\$ / Roll
125 mm - 5" width					
KEBA 100/125/5M	125 mm - 5"	5 m - 16' 5"	4 mil	1.47	24.06
KEBA 100/125/10M	125 mm - 5"	10 m - 33'	4 mil	1.38	45.70
KEBA 100/125	125 mm - 5"	30 m - 98' 5"	4 mil	1.15	112.92
KEBA100/125/300	125 mm - 5"	300 m - 984' 3"	4 mil	1.03	1,016.39
185 mm - 7-1/4" width					
KEBA 100/185/5M	185 mm - 7-1/4"	5 m - 16' 5"	4 mil	1.92	31.51
KEBA 100/185	185 mm - 7-1/4"	30 m - 98' 5"	4 mil	1.59	156.11
250 mm - 10" width					
KEBA 100/250/5M	250 mm - 10"	5 m - 16' 5"	4 mil	2.39	39.27
KEBA 100/250	250 mm - 10"	30 m - 98' 5"	4 mil	2.04	200.73

* The price per foot is for estimation purposes only. Please order using the price per roll.

Schluter®-KERDI-BOARD-ZSA

Schluter®-KERDI-BOARD-ZSA is an adhesive tape for reinforcing the joint areas of KERDI-BOARD panels.



Schluter®-KERDI-BOARD-ZSA			
Joint reinforcement tape			
Item No.	Width	Length	\$ / Roll
KB ZSA 100/45 M	100 mm - 4"	45 m - 148'	19.92

Schluter®-KERDI-BOARD-ZDK

Schluter®-KERDI-BOARD-ZDK is a double-sided adhesive tape used to attach KERDI-BOARD panels in joint areas or similar.



Schluter®-KERDI-BOARD-ZDK			
Double-sided tape			
Item No.	Width	Length	\$ / Roll
KB ZDK 12/10 M	12.5 mm - 1/2"	10 m - 33'	11.21
KB ZDK 19/10 M	19 mm - 3/4"	10 m - 33'	17.36
KB ZDK 30/10 M	30 mm - 1-3/16"	10 m - 33'	27.26



Schluter®-Systems

Waterproofing & uncoupling membranes

Ceramic and stone tiles are durable, easy to maintain, and hygienic, representing the ideal surface coverings. However, today's lightweight construction methods can make the installation of hard surface coverings particularly challenging. Schluter Systems has developed state-of-the-art installation systems that address the problems associated with today's construction methods, allowing the installation of ceramic and stone tiles on virtually any surface.

DITRA provides uncoupling to prevent cracked tiles and grout, while providing effective waterproofing to protect moisture-sensitive substrates. KERDI is a pliable, sheet-applied waterproofing membrane and vapor-retarder ideal for use in tiled showers, bathtub surrounds, and other wet areas.



Schluter®-DITRA and Schluter®-DITRA-XL

Schluter®-DITRA and **Schluter®-DITRA-XL** are polyethylene uncoupling membranes with a grid structure of square cutback cavities and an anchoring fleece laminated to the underside. DITRA and DITRA-XL provide uncoupling through the open rib structure, which allows for in-plane movement that effectively neutralizes the differential movement stresses between the substrate and the tile, thus eliminating the major cause of cracking and delaminating of the tiled surface. In conjunction with tile coverings, DITRA and DITRA-XL form an uncoupling, waterproofing, and vapor management layer, while providing support/load distribution. The combination of these four essential functions allows for the successful installation of tile over a wide range of substrates, including plywood/OSB, concrete, gypsum, heated floors, etc.

DITRA is 1/8" (3.5 mm) thick, which minimizes tile assembly thickness and reduces transitions to lower surface coverings (e.g., carpet, engineered wood, and vinyl). DITRA allows for ceramic tile application over single-layer plywood or OSB subfloors on joists spaced up to 19.2" (488 mm) o.c. DITRA is listed by cUPC®.

DITRA-XL is 5/16" (7 mm) thick, which permits even transitions between tile and 3/4"-thick hardwood flooring. DITRA-XL allows for ceramic tile application over single-layer plywood/OSB subfloors on joists spaced up to 24" (610 mm) o.c.

DITRA and DITRA-XL were evaluated according to the "Standard Method for the Testing and Evaluation of Volatile Organic Chemical Emissions from Indoor Sources Using Environmental Chambers, Version 1.1 for California Specification 01350 and found to comply with the VOC requirements. California Specification 01350 is referenced by various green building standards and rating systems.

For complete information, a step-by-step installation video and the DITRA Installation Handbook are available for download at: **Schluter.com** or by contacting our Customer Service.

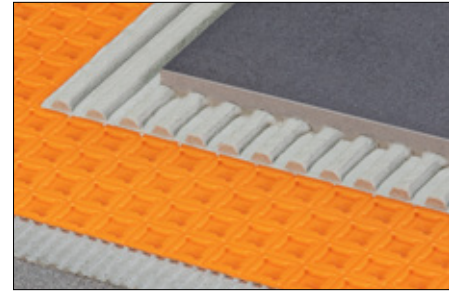
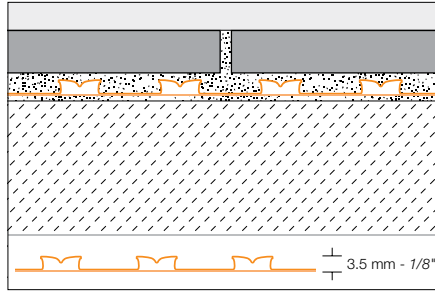

Schluter®-DITRA			
Uncoupling and waterproofing membrane 3.5 mm - 1/8"			
Item No.	Dimensions	\$ / ft² *	\$ / Roll
DITRA 5M	0.995 m x 5.1 m = 5 m² - 3' 3" x 16' 8" = 54 ft²	2.40	129.62
DITRA 150	0.995 m x 14.1 m = 14 m² - 3' 3" x 46' 3" = 150 ft²	2.23	333.84

* The price per square foot is for estimation purposes only. Please order using the price per roll.

DITRA By Pallet

DITRA 30M is shipped as full pallets only. Please order in multiples of the pallet quantity.

Schluter®-DITRA					
Uncoupling and waterproofing membrane 3.5 mm - 1/8"					
Item No.	Dimensions	\$ / ft² *	\$ / Roll	Rolls / Pallet	\$ / Pallet
DITRA 30M	0.995 m x 30.4 m = 30 m² 3' 3" x 99' 8" = 323 ft²	2.10	678.15	9	6,103.35

* The price per square foot is for estimation purposes only. Please order using the price per roll.

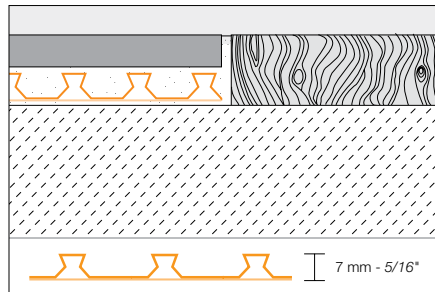

Schluter®-DITRA-XL			
Uncoupling and waterproofing membrane 7 mm - 5/16"			
Item No.	Dimensions	\$ / ft² *	\$ / Roll
DITRA-XL/175	1 m x 16.25 m = 16.25 m² - 3' 3" x 53' 3" = 175 ft²	2.46	430.25

* The price per square foot is for estimation purposes only. Please order using the price per roll.



Schluter®-SET, Schluter®-ALL-SET, and Schluter®-FAST-SET
See page 192



Schluter®-TROWEL
See page 196



Schluter®-DITRA-PS

Schluter®-DITRA-PS is a peel and stick membrane that features a pressure-sensitive adhesive (PSA) to bond the membrane to the substrate, replacing the need for thin-set mortar. Simply remove the transparent release film from the fleece side of the membrane to expose the layer of adhesive and embed into the substrate using a float, screed trowel, or DITRA-ROLLER. DITRA-PS offers the same core functions as DITRA: uncoupling, support/load distribution, waterproofing, and vapor management.

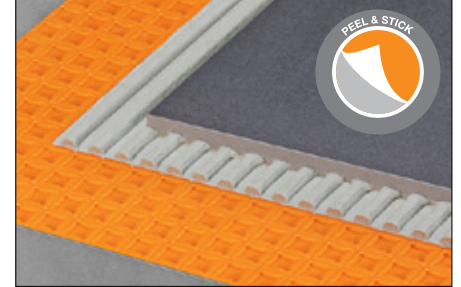
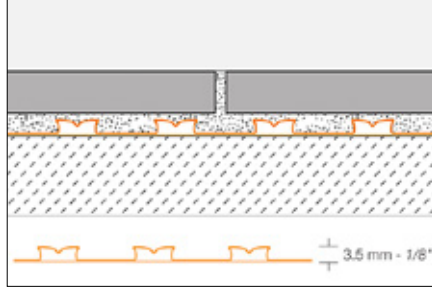

Note: For applications requiring compliance with or certification to the ANSI A118.10 American National Standard Specifications for Load Bearing, Bonded, Waterproof Membranes for Thin-Set Ceramic Tile and Dimension Stone Installation, select the DITRA membrane that is installed with thin-set mortar. Alternatively, the DITRA-PS membrane may be covered with the Schluter®-KERDI membrane, which is certified to meet ANSI A118.10.

Schluter®-DITRA-PS				
Peel and stick uncoupling and waterproofing membrane 3.5 mm - 1/8"				
Item No.	Dimensions	Format	\$ / ft ² *	\$ / Unit
DITRAPS 110	0.985 m x 10.4 m = 10 m ² 3' 2-3/4" x 34' 3/4" = 110 ft²	Roll	2.81	308.55
DITRAPS 25M	0.985 m x 25.4 m = 25 m ² 3' 2-3/4" x 83' 4" = 269 ft²	Roll	2.65	713.39
DITRAPS MA	0.985 m x 0.74 m = 0.72 m ² 3' 2-3/4" x 2' 5" = 7.75 ft²	Sheet	3.01	23.32

* The price per square foot is for estimation purposes only. Please order using the price per roll or per sheet.



Schluter®-PRIMER-PS
See page 195



Schluter®-KERDI-FLEX

Schluter®-KERDI-FLEX is a flexible polyethylene waterproofing strip used to seal movement joints over Schluter®-DITRA in specialty applications where large movements are expected, i.e. over expansion joints or construction joints.

Note: 1 mil = 1 one-thousandth of an inch

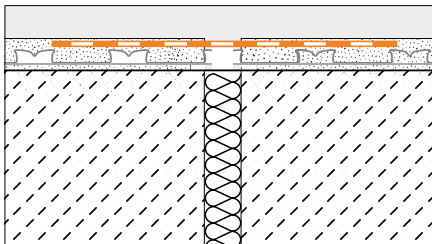

Schluter®-KERDI-FLEX					
Waterproofing strip for use above movement joints					
Item No.	Width	Length	Thickness	\$ / ft *	\$ / Roll
FLEX 125/5M	125 mm - 5"	5 m - 16' 5"	12 mil	2.77	45.47
FLEX 250/5M	250 mm - 10"	5 m - 16' 5"	12 mil	4.49	73.68
FLEX 125/30	125 mm - 5"	30 m - 98' 5"	12 mil	2.11	207.42
FLEX 250/30	250 mm - 10"	30 m - 98' 5"	12 mil	3.83	377.11

* The price per foot is for estimation purposes only. Please order using the price per roll.

Schluter®-KERDI and Schluter®-KERDI-DS

Schluter®-KERDI is a pliable sheet-applied polyethylene waterproofing membrane and vapor retarder that guarantees uniform thickness. It is covered with an anchoring fleece on both sides to anchor the membrane in thin-set mortar and is suitable for waterproofing in conjunction with tiled surfaces on walls and floors. KERDI is 8-mil thick and has a water vapor permeance of 0.90 perms, when tested according to ASTM E96, using Procedure E at 90% relative humidity.

Schluter®-KERDI-DS is a bonded waterproofing membrane and vapor retarder with very low water vapor permeance for use in continuous use steam rooms and similar applications. KERDI-DS is 20-mil thick and features additives to produce a water vapor permeance of 0.19 perms, when tested according to ASTM E96, using Procedure E at 90% relative humidity.

KERDI and KERDI-DS meet the American National Standard for Load Bearing, Bonded, Waterproof Membranes for Thin-Set Ceramic Tile and Dimension Stone Installations (ANSI A118.10). The membranes are listed by cUPC® and evaluated by ICC-ES (Report Nos. ESR-2467 and PMG-1204).

KERDI and KERDI-DS have been evaluated according to the "Standard Method for the Testing and Evaluation of Volatile Organic Chemical Emissions from Indoor Sources Using Environmental Chambers, Version 1.1" for California Specification 01350 and found to comply with the VOC requirements. California Specification 01350 is referenced by various green building standards and rating systems.

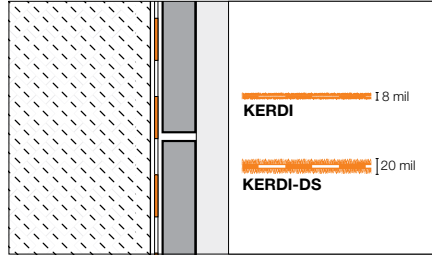

Note: 1 mil = 1 one-thousandth of an inch

Schluter®-KERDI			
Waterproofing membrane			
Item No.	Dimensions	\$ / ft ² *	\$ / Roll
Roll width: 1 m - 3' 3"			
KERDI 200/5M	1 m x 5 m = 5 m ² - 3' 3" x 16' 5" = 54 ft ²	2.40	129.62
KERDI 200/7M	1 m x 7 m = 7 m ² - 3' 3" x 23' = 75 ft ²	2.37	177.53
KERDI 200/10M	1 m x 10 m = 10 m ² - 3' 3" x 33' = 108 ft ²	2.33	251.69
KERDI 200/20M	1 m x 20 m = 20 m ² - 3' 3" x 65' 7" = 215 ft ²	2.24	481.00
KERDI 200	1 m x 30 m = 30 m ² - 3' 3" x 98' 5" = 323 ft ²	2.10	678.15
Roll width: 2 m - 6' 7"			
KERDI 200200/15M	2 m x 15 m = 30 m ² - 6' 7" x 49' 2-1/2" = 323 ft ²	2.10	678.15
KERDI 200200	2 m x 30 m = 60 m ² - 6' 7" x 98' 5" = 646 ft ²	2.01	1,299.31

Schluter®-KERDI-DS			
Waterproofing membrane			
Item No.	Dimensions	\$ / ft ² *	\$ / Roll
KERDI-DS	1 m x 30 m = 30 m ² - 3' 3" x 98' 5" = 323 ft ²	2.85	920.33

* The price per square foot is for estimation purposes only. Please order using the price per roll.



Schluter®-SET, Schluter®-ALL-SET, and Schluter®-FAST-SET
See page 192



Schluter®-TROWEL
See page 196

The **WIDE** Roll

- ✓ Wide roll available in two lengths:
6' 7" x 49' 2-1/2" = **323 ft²** and 6' 7" x 98' 5" = **646 ft²**
- ✓ Fewer seams
- ✓ Faster installation
- ✓ Wide format covers wall area from floor to standard shower head height





Schluter®-KERDI-BAND

Schluter®-KERDI-BAND is a waterproofing strip used to seal butt joints and floor/wall connections with the Schluter®-KERDI, DITRA, and DITRA-HEAT membranes, as well as joints, corners, and fastener penetrations with the Schluter®-KERDI-BOARD building panels.

Note: 1 mil = 1 one-thousandth of an inch

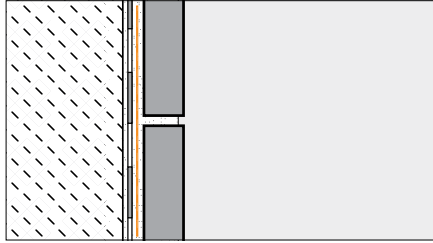

Schluter®-KERDI-BAND					
Waterproofing strip					
Item No.	Width	Length	Thickness	\$ / ft *	\$ / Roll
125 mm - 5" width					
KEBA 100/125/5M	125 mm - 5"	5 m - 16' 5"	4 mil	1.47	24.06
KEBA 100/125/10M	125 mm - 5"	10 m - 33'	4 mil	1.38	45.70
KEBA 100/125	125 mm - 5"	30 m - 98' 5"	4 mil	1.15	112.92
KEBA100/125/300	125 mm - 5"	300 m - 984' 3"	4 mil	1.03	1,016.39
185 mm - 7-1/4" width					
KEBA 100/185/5M	185 mm - 7-1/4"	5 m - 16' 5"	4 mil	1.92	31.51
KEBA 100/185	185 mm - 7-1/4"	30 m - 98' 5"	4 mil	1.59	156.11
250 mm - 10" width					
KEBA 100/250/5M	250 mm - 10"	5 m - 16' 5"	4 mil	2.39	39.27
KEBA 100/250	250 mm - 10"	30 m - 98' 5"	4 mil	2.04	200.73

* The price per foot is for estimation purposes only. Please order using the price per roll.

Schluter®-KERDI-KERECK-F

Schluter®-KERDI-KERECK-F are preformed, seamless corners made of Schluter®-KERDI for waterproofing inside and outside corners.

Note: 1 mil = 1 one-thousandth of an inch

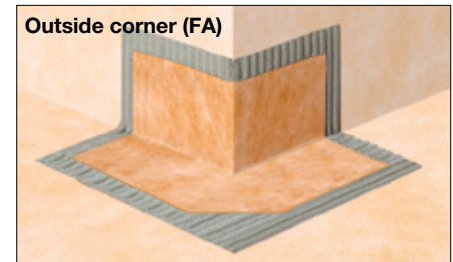
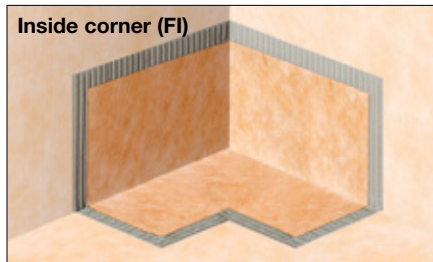

Schluter®-KERDI-KERECK-F			
Waterproofing for 90° corners			
Item No.	Thickness	Packaging	\$ / Package
KERECK/FI 2	4 mil	2 Inside corners	18.56
KERECK/FA 2	4 mil	2 Outside corners	18.56
Waterproofing for 135° corners			
KERECK 135 FI 2	4 mil	2 Inside corners	20.57

Schluter®-KERDI-KERECK-F			
Waterproofing for 90° corners			
Item No.	Thickness	Packaging	\$ / Package
KERECK/FI 10	4 mil	10 Inside corners	88.38
KERECK/FA 10	4 mil	10 Outside corners	88.38
Waterproofing for 135° corners			
KERECK 135 FI 10	4 mil	10 Inside corners	97.68

Schluter®-KERDI-KERS-B

Schluter®-KERDI-KERS-B are preformed, seamless corners for waterproofing 135° angles between triangular shower benches and walls or for curb corners in neo-angle shower applications.

Note: 1 mil = 1 one-thousandth of an inch



Schluter®-KERDI-KERS-B				
Waterproofing corners				
Item No.	Thickness	Description	Packaging	\$ / Package
KERECK 135 FI 2	4 mil	Inside corner, 135°	2 units	20.57
KERECK 135 FI 10	4 mil	Inside corner, 135°	10 units	97.68
KERSB 135 K LR	4 mil	Outside corner, 135°	1 right and 1 left	43.39
KERSB 135 K 5LR	4 mil	Outside corner, 135°	5 right and 5 left	206.03
KERSB 135 K	4 mil	Bench/neo-angle corner kit	1 right and 1 left 135° outside corner, and 2 135° inside corners	63.93

Schluter®-KERDI-KERS

Schluter®-KERDI-KERS are preformed, seamless corners made of Schluter®-KERDI for waterproofing floor/wall/shower base connections in curbless shower applications where the Schluter®-KERDI-LINE linear drain is installed adjacent to the wall.

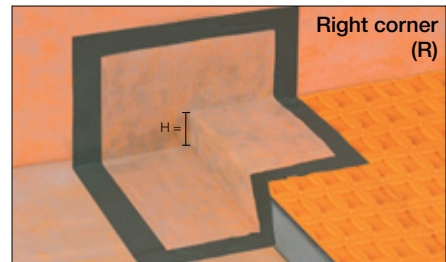
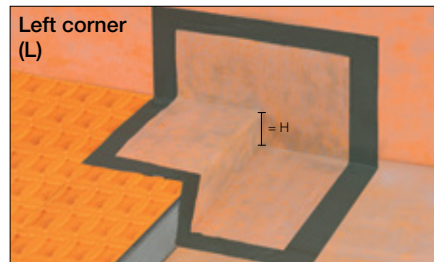

Schluter®-KERDI-KERS				
Waterproofing for corners				
Item No.	H = mm - in.	Thickness	Description	\$ / Unit
KERS 20 L	20 - 3/4	4 mil	Left inside corner	24.96
KERS 28 L	28 - 1-3/32	4 mil	Left inside corner	24.96
KERS 20 R	20 - 3/4	4 mil	Right inside corner	24.96
KERS 28 R	28 - 1-3/32	4 mil	Right inside corner	24.96



Schluter®-KERDI-SEAL-PS/-MV

Schluter®-KERDI-SEAL-PS/-MV pre-fabricated seals are cut sections of the Schluter®-KERDI waterproofing membrane designed to seal protrusions through the Schluter®-KERDI or Schluter®-DITRA/DITRA-XL, as well as Schluter®-KERDI-BOARD building panels. Schluter®-KERDI-SEAL-PS and -MV feature overmolded rubber gaskets and are used to seal pipe protrusions and protect moisture-sensitive solid backing panels at the mixing valve.

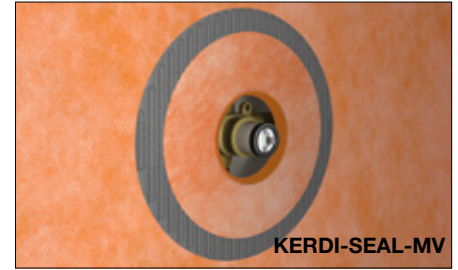
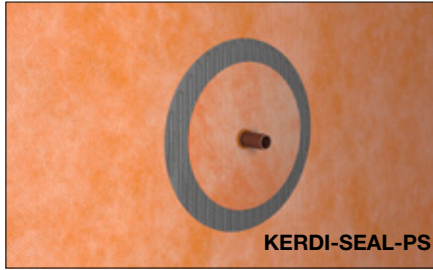

Note: 1 mil = 1 one-thousandth of an inch

Schluter®-KERDI-SEAL-PS				
Pipe seal with overmolded rubber gasket				
Item No.	Pipe nipple opening diam.	Thickness	Packaging	\$ / Package
KMS172/12	12.5 mm - 1/2"	4 mil	1 unit	9.15
KMS172/20	20 mm - 3/4"	4 mil	1 unit	9.15
KMS10172/12	12.5 mm - 1/2"	4 mil	10 units	82.30
KMS10172/20	20 mm - 3/4"	4 mil	10 units	82.30

Schluter®-KERDI-SEAL-MV				
Mixing valve seal with overmolded rubber gasket				
Item No.	Mixing valve opening diam.	Thickness	Packaging	\$ / Package
KMSMV235/114	114 mm - 4-1/2"	4 mil	1 unit	10.55
KMSMV10235/114	114 mm - 4-1/2"	4 mil	10 units	94.97

Schluter®-KERDI-KM

Schluter®-KERDI-KM prefabricated seal is cut sections of the Schluter®-KERDI waterproofing membrane designed to seal protrusions through the KERDI or Schluter®-DITRA/DITRA-XL membranes. KERDI-KM is designed to be used in conjunction with Schluter®-KERDI-FIX or equivalent sealant to seal around pipes or other similar elements.

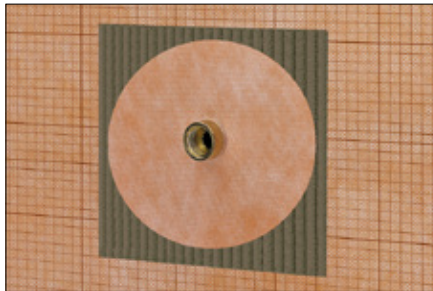

Schluter®-KERDI-KM				
Pipe seal				
Item No.	Pipe nipple opening diam.	Thickness	Packaging	\$ / Package
KM5117/22	22 mm - 7/8"	4 mil	5 units	10.77

Schluter®-KERDI-FIX

Schluter®-KERDI-FIX is a single-component sealing and bonding compound with a silane-modified polymer base. It is odor-neutral, UV- and weather-resistant, and contains no solvents. KERDI-FIX is elastomeric and bonds well to most materials, such as wood, stone, concrete, metal, glass, and many plastics. KERDI-FIX is suitable for bonding the Schluter®-KERDI waterproofing membrane and Schluter®-KERDI-BAND to fixed building elements. KERDI-FIX is also suitable for use as a sealant.



Schluter®-KERDI-FIX	
Cartridge (290 ml – 9.81 fl oz)	
Item No.	\$ / Unit
KERDIFIX / + color*	31.10

Schluter®-KERDI-FIX	
Tube (100 ml – 3.38 fl oz) - Grey (G)	
Item No.	\$ / Unit
KERDIFIX 100 G	18.06

***Color Codes**

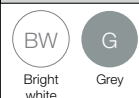

⚠ WARNING: Reproductive Harm www.P65Warnings.ca.gov



Schluter®-REFLEECE

Removable fleece

Whether you want to cover an existing hard surface floor covering for a fresh new look or want to create a temporary floor covering that will be easy to remove in the future, REFLEECE offers a practical solution. The self-adhesive fleece enables the simple removal of coverings without leaving any residue or damaging the subfloor.





Schluter®-REFLEECE

Schluter®-REFLEECE is a removable fleece used to create temporary floor coverings. Made of recycled PET with a self-adhesive coating on the back, REFLEECE measures 1/32" (0.8 mm) thick and is suitable for the application of temporary, removable tile and natural stone coverings. REFLEECE is easy to install and can be removed during deconstruction without causing damage to the existing subfloor. An impact sound improvement value up to 9dB was measured (according to DIN EN ISO 10140) for this assembly. Install with the Schluter®-KERDI-BOARD-ZSA adhesive tape for connecting REFLEECE at the seams.

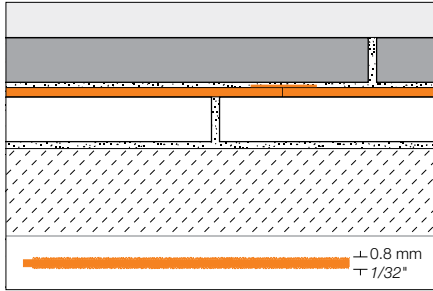

Schluter®-REFLEECE		
Underlayment for temporary floor coverings 0.8 mm - 1/32"		
Item No.	Dimensions	\$ / Roll
REFL 30M	1 m x 30 m = 30 m ² 3' 3" x 98' 5" = 323 ft ²	682.25

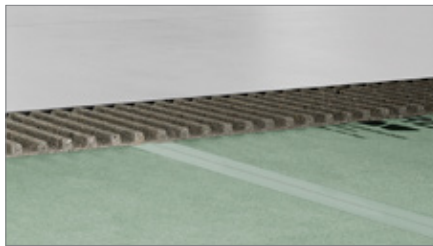

Schluter®-KERDI-BOARD-ZSA			
Joint reinforcement tape			
Item No.	Width	Length	\$ / Roll
KB ZSA 100/45 M	100 mm - 4"	45 m - 148'	19.92



Schluter®-DITRA-HEAT-E

Electric floor warming system with integrated uncoupling technology

Ceramic and stone tiles are the ideal surface coverings because they are durable, easy to maintain, and hygienic. However, two common barriers to the selection of tile as a floor covering are concerns about cracking and the perception that tiles are cold.

DITRA-HEAT integrates customizable, comfortable electric floor warming with the functions associated with DITRA: uncoupling, waterproofing, vapor management and support to ensure a long lasting installation, thereby addressing the two most common concerns.



DITRA-HEAT-PS (page 120)

All the benefits of our original electric floor warming system, now with a peel & stick self-adhesive backing to get the job done even faster.



Schluter®-DITRA-HEAT and DITRA-HEAT-DUO

Schluter®-DITRA-HEAT and **DITRA-HEAT-DUO** are polypropylene membranes with a cut-back stud structure and an anchoring fleece laminated to the underside. Both membranes are designed to secure the DITRA-HEAT-E-HK electric floor heating cables and provide uncoupling, waterproofing, vapor management and support to ensure a long lasting installation.

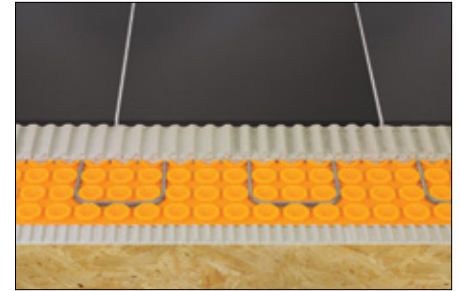
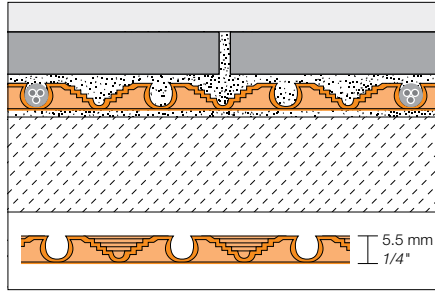

DITRA-HEAT-DUO offers the same functions as DITRA-HEAT, but features a thicker bonding fleece that adds two more benefits, while still supporting the covering to ensure a lasting installation:

Sound Control

DITRA-HEAT-DUO reduces impact sound transmission through floor-ceiling assemblies, making it ideal for multi-story construction. DITRA-HEAT-DUO provides a ΔIIC contribution of 20, when tested per ASTM E2179 in a thin-set assembly with porcelain tile.

Thermal Break

DITRA-HEAT-DUO reduces heat loss to the substrate to improve the floor warming response time over concrete substrates by up to 70%.

The thickness of the mat, including the stud structure, of DITRA-HEAT is 1/4" (5.5 mm) and DITRA-HEAT-DUO is 5/16" (8 mm).

The DITRA-HEAT and DITRA-HEAT-DUO membranes feature cutting grooves, which provide an easy-cut guide and enhanced membrane flexibility.

For complete information, a step-by-step installation video, Installation Handbook, and Technical Data Sheet are available for download at: www.schluter.com or by contacting our Customer Service.

Schluter®-DITRA-HEAT				
Uncoupling and waterproofing membrane				
Item No.	Dimensions	Format	\$ / ft²*	\$ / Unit
DH5 12M	0.98 m x 12.76 m = 12.5 m² 3' 2-5/8" x 41' 10-3/4" = 134.5 ft²	Roll	2.98	401.29
DH5 MA	0.98 m x 0.8 m = 0.78 m² 3' 2-5/8" x 2' 7-3/8" = 8.4 ft²	Sheet	3.10	26.04

* The price per square foot is for estimation purposes only. Please order using the price per roll or per sheet.

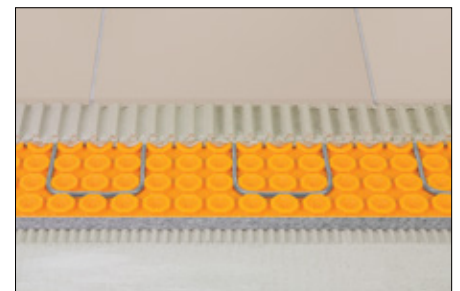
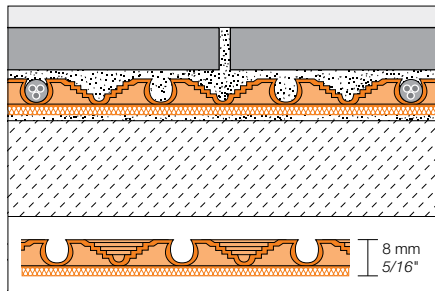

Schluter®-DITRA-HEAT-DUO				
Uncoupling and waterproofing membrane with sound control and thermal break				
Item No.	Dimensions	Format	\$ / ft²*	\$ / Unit
DHD8 10M	0.98 m x 10.2 m = 10 m² 3' 2-5/8" x 33' 6-1/2" = 108 ft²	Roll	4.28	462.29
DHD8 MA	0.98 m x 0.8 m = 0.78 m² 3' 2-5/8" x 2' 7-3/8" = 8.4 ft²	Sheet	4.48	37.61

* The price per square foot is for estimation purposes only. Please order using the price per roll or per sheet.



Schluter®-SET, Schluter®-ALL-SET, and Schluter®-FAST-SET
See page 192



Schluter®-TROWEL
See page 196



Schluter®-DITRA-HEAT-PS and DITRA-HEAT-DUO-PS

Schluter®-DITRA-HEAT-PS and **DITRA-HEAT-DUO-PS** are peel and stick membranes that feature a pressure-sensitive adhesive (PSA) to bond the membrane to the substrate, replacing the need for thin-set mortar. Simply remove the transparent release film from the fleece side of the membrane to expose the layer of adhesive and embed into substrate using a float, screed trowel, or DITRA-ROLLER. The -PS versions offer the same core functions as DITRA-HEAT and DITRA-HEAT-DUO. Both peel and stick membranes are designed to secure the DITRA-HEAT-E-HK electric floor heating cables, and provide uncoupling, waterproofing, vapor management, and load support to ensure a long-lasting tile installation.

DITRA-HEAT-DUO-PS features a thicker bonding fleece that additionally provides sound control to reduce impact sound transmission through floor-ceiling assemblies and a thermal break that reduces heat loss to the substrate to improve floor warming response time, particularly over concrete substrates.

DITRA-HEAT-PS is 1/4" (5.5 mm) -thick and DITRA-HEAT-DUO-PS is 5/16" (8 mm) -thick. Both membranes feature cutting grooves, which provide an easy-cut guide and enhanced membrane flexibility.

A primer is not required to install DITRA-HEAT-PS/-DUO-PS, however, a primer such as Schluter®-PRIMER-PS or PRIMER-U is recommended when installing on a difficult-to-bond-to substrate.

Note: For applications requiring compliance with or certification to the ANSI A118.10 American National Standard Specifications for Load Bearing, Bonded, Waterproof Membranes for Thin-Set Ceramic Tile and Dimension Stone Installation, select the DITRA-HEAT or DITRA-HEAT-DUO membranes that are installed with thin-set mortar. Alternatively, the DITRA-HEAT-PS or DITRA-HEAT-DUO-PS membranes may be covered with the Schluter®-KERDI membrane, which is certified to meet ANSI A118.10.

For complete information, a step-by-step installation video, Installation Handbook, and Technical Data Sheet are available for download at: Schluter.com or by contacting our Customer Service.



Schluter®-PRIMER-PS
See page 195

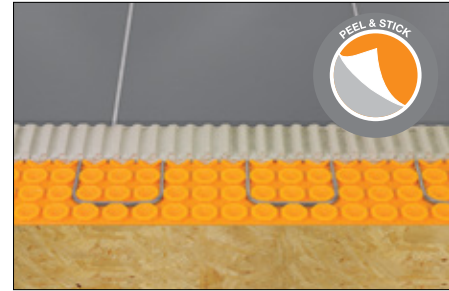
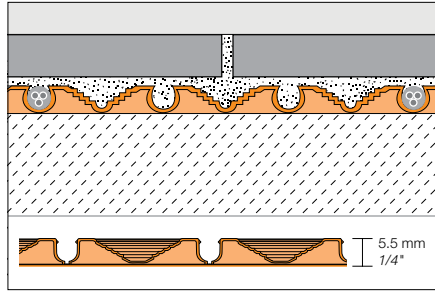

Schluter®-DITRA-HEAT-PS				
Peel and stick floor warming				
Item No.	Dimensions	Format	\$ / ft ² *	\$ / Unit
DHPS5 12M	0.98 m x 12.76 m = 12.5 m ² 3' 2-5/8" x 41' 10-3/4" = 134.5 ft ²	Roll	3.73	501.60
DHPS5 MA	0.98 m x 0.8 m = 0.78 m ² 3' 2-5/8" x 2' 7-3/8" = 8.4 ft ²	Sheet	3.88	32.56

* The price per square foot is for estimation purposes only. Please order using the price per roll or per sheet.

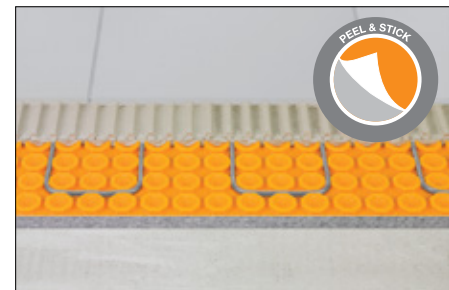
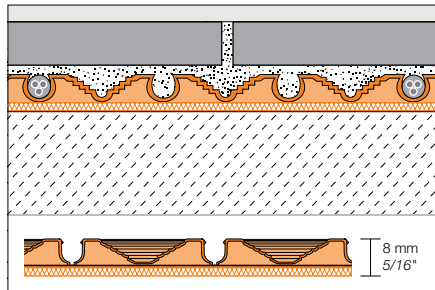

Schluter®-DITRA-HEAT-DUO-PS				
Peel and stick floor warming with sound control and thermal break				
Item No.	Dimensions	Format	\$ / ft ² *	\$ / Unit
DHDS8 10M	0.98 m x 10.2 m = 10 m ² 3' 2-5/8" x 33' 6-1/2" = 108 ft ²	Roll	5.35	577.88
DHDS8 MA	0.98 m x 0.8 m = 0.78 m ² 3' 2-5/8" x 2' 7-3/8" = 8.4 ft ²	Sheet	5.60	47.01

* The price per square foot is for estimation purposes only. Please order using the price per roll or per sheet.





Schluter®-DITRA-HEAT-E-HK

Schluter®-DITRA-HEAT-E-HK are twisted pair heating cables designed for integration with the DITRA-HEAT uncoupling membrane in interior floor warming applications. The cables can be installed without returning to the thermostat and produce virtually zero electromagnetic fields.

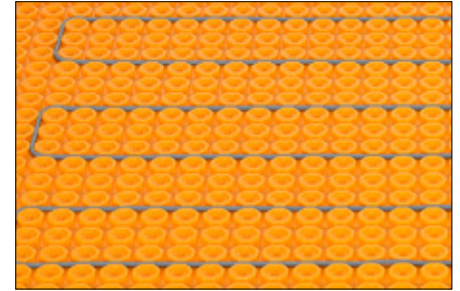

BEFORE ordering heating cables, see IMPORTANT ordering information on page 123.

Schluter®-DITRA-HEAT-E-HK													
Heating cable													
Item No.	Heating Cable Length		Area Covered per Cable Spacing				Total Power (W)	Avg. Power per Unit Area per Cable Spacing				Current (Amps)	\$ / Length
	(ft)	(m)	Regular 3 Stud		Alternating 3-2 Stud			Regular 3 Stud		Alternating 3-2 Stud			
Heating Cable (120 V)													
DHE HK 120 11	35.3	10.8	10.7	1.0	8.9	0.8	135	12.6	136	15.2	164	1.1	228.64
DHE HK 120 16	52.9	16.1	16.0	1.5	13.3	1.2	203	12.7	136	15.2	164	1.7	254.90
DHE HK 120 21	70.5	21.5	21.3	2.0	17.8	1.7	270	12.7	136	15.2	164	2.3	305.81
DHE HK 120 27	88.2	26.9	26.7	2.5	22.2	2.1	338	12.7	136	15.2	164	2.8	328.41
DHE HK 120 32	105.8	32.2	32.0	3.0	26.7	2.5	405	12.7	136	15.2	164	3.4	355.35
DHE HK 120 38	124.1	37.8	37.5	3.5	31.3	2.9	475	12.7	136	15.2	164	4.0	380.81
DHE HK 120 43	141.1	43.0	42.7	4.0	35.6	3.3	540	12.7	136	15.2	164	4.5	403.05
DHE HK 120 51	169.8	51.8	51.4	4.8	42.8	4.0	650	12.7	136	15.2	164	5.4	452.73
DHE HK 120 64	212.9	64.9	64.4	6.0	53.7	5.0	815	12.7	136	15.2	164	6.8	502.08
DHE HK 120 73	240.2	73.2	72.7	6.8	60.6	5.6	920	12.7	136	15.2	164	7.7	551.87
DHE HK 120 83	275.5	84.0	83.3	7.7	69.4	6.5	1055	12.7	136	15.2	164	8.8	618.95
DHE HK 120 92	303.0	92.4	91.7	8.5	76.4	7.1	1160	12.7	136	15.2	164	9.7	675.73
DHE HK 120 102	336.9	102.7	101.9	9.5	84.9	7.9	1290	12.7	136	15.2	164	10.7	743.57
DHE HK 120 113	372.2	113.4	112.6	10.5	93.8	8.7	1425	12.7	136	15.2	164	11.9	812.03
DHE HK 120 134	444.0	135.3	134.3	12.5	111.9	10.4	1700	12.7	136	15.2	164	14.2	888.44
Heating Cable (240 V)													
DHE HK 240 11	35.3	10.8	10.7	1.0	8.9	0.8	135	12.6	136	15.2	164	0.6	228.64
DHE HK 240 16	53.1	16.2	16.1	1.5	13.4	1.2	203	12.6	136	15.2	164	0.8	254.76
DHE HK 240 21	70.6	21.5	21.4	2.0	17.8	1.7	270	12.7	136	15.2	164	1.1	305.83
DHE HK 240 27	88.2	26.9	26.7	2.5	22.2	2.1	338	12.7	136	15.2	164	1.4	328.40
DHE HK 240 32	105.8	32.2	32.0	3.0	26.7	2.5	405	12.7	136	15.2	164	1.7	355.35
DHE HK 240 38	124.1	37.8	37.5	3.5	31.3	2.9	475	12.7	136	15.2	164	2.0	380.86
DHE HK 240 43	141.0	43.0	42.6	4.0	35.5	3.3	540	12.7	136	15.2	164	2.3	403.12
DHE HK 240 53	176.3	53.7	53.3	5.0	44.4	4.0	675	12.7	136	15.2	164	2.8	452.57
DHE HK 240 64	211.6	64.5	64.0	5.9	53.3	5.0	810	12.7	136	15.2	164	3.4	502.26
DHE HK 240 75	248.2	75.7	75.1	7.0	62.6	5.8	950	12.7	136	15.2	164	4.0	551.61
DHE HK 240 85	282.1	86.0	85.3	7.9	71.1	6.6	1080	12.7	136	15.2	164	4.5	602.77
DHE HK 240 103	339.4	103.4	102.7	9.5	85.6	7.9	1300	12.7	136	15.2	164	5.4	677.87
DHE HK 240 129	425.8	129.8	128.8	12.0	107.3	10.0	1630	12.7	136	15.2	164	6.8	757.17
DHE HK 240 145	480.5	146.5	145.3	13.5	121.1	11.3	1840	12.7	136	15.2	164	7.7	823.37
DHE HK 240 167	551.0	167.9	166.7	15.5	138.9	12.9	2110	12.7	136	15.2	164	8.8	887.75
DHE HK 240 183	605.9	184.7	183.3	17.0	152.7	14.2	2320	12.7	136	15.2	164	9.7	969.69
DHE HK 240 204	673.8	205.4	203.8	18.9	169.9	15.8	2580	12.7	136	15.2	164	10.7	1,044.19
DHE HK 240 225	744.4	226.9	225.2	20.9	187.7	17.4	2850	12.7	136	15.2	164	11.9	1,121.92

Each heating cable includes 2 floor temperature sensors compatible with the Schluter®-DITRA-HEAT-E thermostats and features an approximately 7 ft (2.1 m) long cold lead.



Schluter®-DITRA-HEAT-E-HK Heating Cables 208 V Applications

Schluter®-DITRA-HEAT offers complete flexibility when creating warm floors in any application. DITRA-HEAT-E-HK heating cables are designed for use with common 120 V and 240 V power sources. 208 V power sources are used in some cases to handle larger loads (e.g., HVAC equipment, motors, etc.) or to improve energy efficiency.

Schluter-Systems recommends using the DITRA-HEAT-E-HK 240 V heating cables when a 208 V power source is present. However, this will reduce the heating power by 25% to 9.5 W/ft² at the standard 3-stud cable spacing, which may not be sufficient power to warm the floor in these applications. To offset the effect

of the lower voltage, we recommend installing the heating cable at a 2-stud spacing in these applications. This results in an increased heating power of 14.2 W/ft², which will ensure adequate performance.

The heating cable will cover 33% less area when spaced at 2 studs compared to 3 studs. Therefore, a longer heating cable must be selected to cover a given area in these applications. Coverage for each 240 V heating cable spaced at 2 studs can be found in the table below.



DITRA-HEAT-E-HK 240 V Heating Cables in 208 V Applications at 2 Stud Spacing

Item No.	Length (ft - m)	Area (ft ² - m ²)	Power (W)	Average Power (W/ft ² - W/m ²)	Current (A)
DHE HK 240 11	35.3 – 10.8	7.1 – 0.7	101	14.2 - 152.8	0.5
DHE HK 240 16	53.1 – 16.2	10.7 – 1.0	152	14.2 - 152.8	0.7
DHE HK 240 21	70.5 – 21.5	14.2 – 1.3	203	14.2 - 152.8	1.0
DHE HK 240 27	88.2 – 26.9	17.8 – 1.7	254	14.2 - 152.8	1.2
DHE HK 240 32	105.8 – 32.2	21.3 – 2.0	304	14.2 - 152.8	1.5
DHE HK 240 38	124.1 – 37.8	25.0 – 2.3	356	14.2 - 152.8	1.7
DHE HK 240 43	141 – 43.0	28.4 – 2.6	405	14.2 - 152.8	1.9
DHE HK 240 53	176.3 – 53.7	35.5 – 3.3	506	14.2 - 152.8	2.4
DHE HK 240 64	211.6 – 64.5	42.7 – 4.0	608	14.2 - 152.8	2.9
DHE HK 240 75	248.2 – 75.7	50.0 – 4.7	713	14.2 - 152.8	3.4
DHE HK 240 85	282.1 – 86.0	56.9 – 5.3	810	14.2 - 152.8	3.9
DHE HK 240 103	339.4 – 103.4	68.4 – 6.4	975	14.2 - 152.8	4.7
DHE HK 240 129	425.8 – 129.8	85.8 – 8.0	1223	14.2 - 152.8	5.9
DHE HK 240 145	480.5 – 146.5	96.9 – 9.0	1380	14.2 - 152.8	6.6
DHE HK 240 167	551 – 167.9	111.1 – 10.3	1583	14.2 - 152.8	7.6
DHE HK 240 183	605.9 – 184.7	122.1 – 11.4	1740	14.2 - 152.8	8.4
DHE HK 240 204	673.8 – 205.4	135.8 – 12.6	1935	14.2 - 152.8	9.3
DHE HK 240 225	744.4 – 226.9	150.1 – 13.9	2138	14.2 - 152.8	10.3

We recommend consulting with a qualified electrician for design and installation of your DITRA-HEAT system on a 208 V power source. Keep in mind during design of the system that the DITRA-HEAT-E thermostats have an electrical current limit of 15 A.



IMPORTANT Ordering Information for Schluter®-DITRA-HEAT Cables

- Do not purchase a heating cable the same size as the area to be tiled; this will be too much heating cable!
- Very important: **Never CUT or modify the heating cable in any way.** This would change the cable resistance, will cause damage to the cable, and could cause cable overheating.
- A cable spacing of 3 studs is standard
- Cable may also be spaced at continuously alternating 3 stud – 2 stud – 3 stud intervals in isolated areas or over the entire floor. This practice may be desirable to increase heat output (e.g., over uninsulated on or below grade concrete subfloors) or to consume more cable length in a given area (e.g., when using the standard 3 stud spacing doesn't allow the selected cable to fit the floor area and respect minimum spacing requirements from walls, partitions, etc.)
- A cable spacing of 4 studs is not recommended, as it can produce inconsistent floor surface temperatures
- Minimum spacing from walls, partitions, and fixed cabinets is 2" (50 mm).
- Minimum spacing from other heat sources (baseboard heaters, fireplaces, etc.) is 8" (200 mm).
- Minimum spacing from any plumbing drain and forced air heating ducts is 4" (100 mm).
- Minimum spacing from the centerline of toilet drain is 7" (180 mm).
- The heating section of the cable must be entirely installed under the floor covering. The installation is characterized as a Type C (Embedded Floor Warming) application. In order to prevent a fire hazard, do not install it anywhere else (e.g. in a wall).
- NEVER install the heating cable under vanities with no air space beneath, bathtub platforms, free-standing bathtubs with no air space beneath, kitchen cabinets or any other fixtures or in clothing closets. Excessive heat will build up in these confined spaces and may cause cable overheating.
- It is helpful to plan the location of a buffer zone, as it is not possible to predict where the heating cable will end. The buffer zone is an area where heating is not essential and heating cable installation is not planned (e.g., behind a toilet or adjacent to a door opening). This area allows for placement of excess heating cable. Heating cables may also be installed 6" (150 mm) from the wall to create a buffer zone.
- Heating cable testing is required while the heating cable is on the spool and at two subsequent steps during installation to ensure cable quality and for warranty purposes.

Schluter®-DITRA-HEAT-E-HK-RK Heating Cable Repair Kit and Schluter®-DITRA-HEAT-E-HK-SK Heating Cable Splice Kit

Schluter®-DITRA-HEAT-E-HK-RK is a repair kit for DITRA-HEAT-E-HK heating cables. The kit contains all the material to replace one section of heating cable (gray section) up to 10" (25 cm) long or less in the event of damage, such as cuts by other trades during installation.

Schluter®-DITRA-HEAT-E-HK-SK is a splice kit for DITRA-HEAT-E-HK heating cables. The kit contains all the material to replace one factory splice of the heating cable.

Please visit www.schluter.com for ordering information.

WARNINGS

- Heating cable repairs must be conducted by a qualified electrician in accordance with this heating cable repair procedure, the National Electric Code (USA) or Canadian Electric Code Part I (CAN) as applicable and the Schluter®-DITRA-HEAT Installation Handbook. All electrical connections must be made by a qualified electrician, according to the electrical and building codes effective in your region.
- **Prior to commencing a repair:** Any known deviations from the Schluter®-DITRA-HEAT Installation Handbook and/or applicable code(s) must be corrected. All cable installation and repair instructions must be followed in order to avoid personal injuries or property damage.
- Do not use these kits to splice different heating cables together. These kits are only intended for making repairs to a single cable.
- The heating cable cannot be shortened or altered to fit.
- **Very important:** Never CUT the heating cable. This could change the cable resistance and could lead to a fire.
- **WARRANTY DISCLAIMER:** Any deviation from the DITRA-HEAT Installation Handbook (which includes damage to the DITRA-HEAT-E-HK heating cables) voids the Schluter®-DITRA-HEAT Limited limited Warranty and warranty coverage is not reinstated upon repair of the heating cable. SCHLUTER SYSTEMS FURTHER DISCLAIMS ANY AND ALL WARRANTIES EXPRESSED OR IMPLIED, INCLUDING BUT NOT LIMITED TO THE IMPLIED WARRANTIES OF MERCHANTABILITY OR FITNESS FOR A PARTICULAR PURPOSE AND ANY AND ALL LIABILITY ARISING FROM THE ELECTRICIAN SERVICES.



Schluter®-DITRA-HEAT-E Thermostats

Schluter®-DITRA-HEAT-E digital thermostats control the DITRA-HEAT-E-HK heating cables (both 120 V and 240 V). All thermostats feature a 5 mA built-in ground fault circuit interrupter (GFCI) with indicator light, and have an electrical current limit of 15 amps.

Schluter®-DITRA-HEAT-E-WiFi programmable Wi-Fi thermostat offers all the same features as the Programmable Touchscreen model, with additional Wi-Fi functionality that enables the user to control the DITRA-HEAT electric floor warming system from a mobile app or online.

Schluter®-DITRA-HEAT-E-RT programmable touchscreen thermostat features six programming periods per day, a set-up wizard, energy log, and a QR code for quick access to system settings.

Schluter®-DITRA-HEAT-E-R non-programmable version features simple on/off functionality.

Schluter®-DITRA-HEAT-E-WiFi		
Touchscreen programmable Wi-Fi digital floor thermostat		
Item No.	Description	\$ / Unit
DHE RT 104/BW	Touchscreen programmable Wi-Fi thermostat in bright white	357.52

according to the following standards: UL 60730-1, UL 60730-2-9, CSA E60730-1, CSA E60730-2-9, UL E-file: E157297, GFCI: UL 943 4th ed., CSA C22.2 No. 144.1-06



Wi-Fi

Schluter®-DITRA-HEAT-E-RT		
Touchscreen programmable digital floor thermostat		
Item No.	Description	\$ / Unit
DHE RT 102/BW	Touchscreen programmable thermostat in bright white	281.08

according to the following standards: UL 60730, CSA E60730-1, UL E-file: E157297, GFCI: UL 943, CSA C22.2 No.144.1-06



RT

Schluter®-DITRA-HEAT-E-R		
Non-programmable digital floor thermostat		
Item No.	Description	\$ / Unit
DHE RT 103/BW	Non-programmable thermostat in bright white	197.25

according to the following standards: UL 60730, CSA E60730-1, UL E-file: E157297, GFCI: UL 943, CSA C22.2 No.144.1-06



R

Schluter®-DITRA-HEAT-E-RR

Schluter®-DITRA-HEAT-E-RR is a power module that extends power output when used in conjunction with the DITRA-HEAT-E-WiFi, -RT, or -R thermostats. The power module is designed to be used in large floor applications where the heating load exceeds 15 amps, in order to maintain a single point of control. Up to 16 DITRA-HEAT-E-RR power modules may be connected in series via low voltage signal wire to a single DITRA-HEAT-E-WiFi, -RT, or -R thermostat. The power module also features a 5 mA built-in GFCI.

Schluter®-DITRA-HEAT-E-RR		
Power module		
Item No.	Description	\$ / Unit
DHE RR 1/BW	Power module	172.59

according to the following standards: CSA E60730-1, GFCI: UL 943, CSA C22.2 No.144.1-06





Smart Thermostat for the DITRA-HEAT Floor Warming System







Schluter®-DITRA-HEAT-E-RS1 Smart Thermostat

Schluter®-DITRA-HEAT-E-RS1 smart thermostat features a sleek, versatile design with a mirror finish, and third-party integration with popular voice and home assistants to easily include floor warming into your smart home capabilities. Works with Apple Home, Google Home, and Alexa. Download the Schluter Smart Thermostat app to get convenient, remote access to your DITRA-HEAT floor warming system. The DITRA-HEAT-E-RS1 thermostat controls both the 120 V and 240 V DITRA-HEAT-E-HK heating cables. It features a Class A (5 mA) built-in ground fault circuit interrupter (GFCI) with indicator light and has an electrical current limit of 15 amps.



Schluter®-DITRA-HEAT-E-RS1		
Smart digital floor thermostat		
Item No.	Description	\$ / Unit
DHE RT 105/BW	Smart thermostat with Wi-Fi, app, & voice control	364.88



 Certified to the following standards: UL 60730-1, UL 60730-2-9, UL 943, CAN/CSA E60730-1, CAN/CSA-E60730-2-9, CSA C22.2 No.144.1

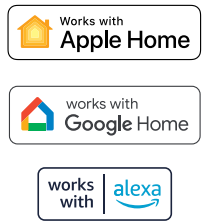

Schluter®-DITRA-HEAT-E-RRS

Schluter®-DITRA-HEAT-E-RRS is a power module specifically designed for the DITRA-HEAT-E-RS1 smart thermostat. The power module may be used when the heating load exceeds 15 amps (e.g., in large floor applications) to maintain a single point of control. Features an input and output voltage of 120 V, 208 V, or 240 V, and a control input from the thermostat of 24 Vdc. The power module also includes a built-in class A GFCI.

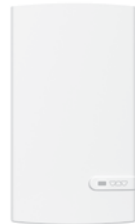

Schluter®-DITRA-HEAT-E-RRS		
Power module		
Item No.	Description	\$ / Unit
DHE RR 2/BW	Power module	194.46

 Certified to the following standards: UL 60730-1, UL 60730-2-9, UL 943, CAN/CSA E60730-1, CAN/CSA-E60730-2-9, CSA C22.2 No.144.1



Schluter®-Shower System

Complete waterproofing system for tiled showers

Schluter Systems provides an integrated family of products in which the individual components collectively form a bonded watertight assembly. The Schluter-Shower System eliminates the risk of failures due to both vapor and water penetration, is maintenance-free, and dramatically reduces total installation time.





Waterproofing

Waterproofing membranes provide protection—and peace-of-mind—behind your shower walls and other tiled elements subject to moisture.

KERDI and KERDI-DS are pliable, sheet-applied, bonded waterproof membranes and vapor retarders with limited crack-bridging capabilities. Accessories made out of KERDI, including waterproofing strips, seamless corners, and pipe and mixing valve seals help complete the waterproofing process to ensure that your shower or bath surround is well-protected against mold and mildew.

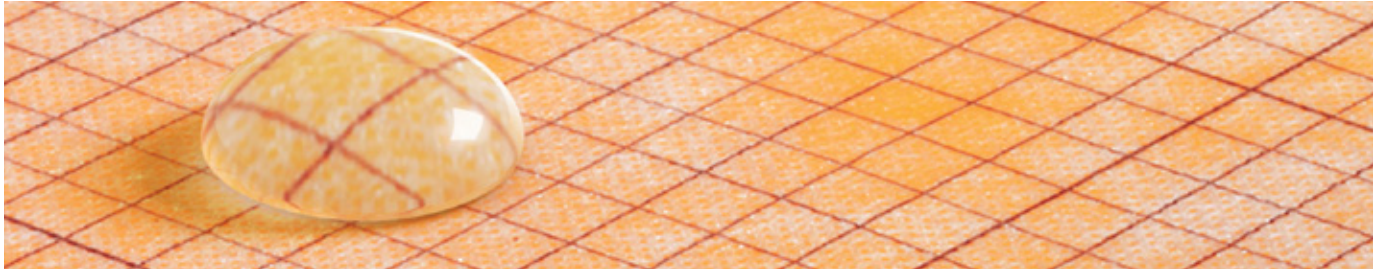

Schluter®-KERDI and Schluter®-KERDI-DS

Schluter®-KERDI is a pliable sheet-applied polyethylene waterproofing membrane and vapor retarder that guarantees uniform thickness. It is covered with an anchoring fleece on both sides to anchor the membrane in thin-set mortar and is suitable for waterproofing in conjunction with tiled surfaces on walls and floors. KERDI is 8-mil thick and has a water vapor permeance of 0.90 perms, when tested according to ASTM E96, using Procedure E at 90% relative humidity.

Schluter®-KERDI-DS is a bonded waterproofing membrane and vapor retarder with very low water vapor permeance for use in continuous use steam rooms and similar applications. KERDI-DS is 20-mil thick and features additives to produce a water vapor permeance of 0.19 perms, when tested according to ASTM E96, using Procedure E at 90% relative humidity.

KERDI and KERDI-DS meet the American National Standard for Load Bearing, Bonded, Waterproof Membranes for Thin-Set Ceramic Tile and Dimension Stone Installations (ANSI A118.10). The membranes are listed by cJPC® and evaluated by ICC-ES (Report Nos. ESR-2467 and PMG-1204).

KERDI and KERDI-DS have been evaluated according to the "Standard Method for the Testing and Evaluation of Volatile Organic Chemical Emissions from Indoor Sources Using Environmental Chambers, Version 1.1" for California Specification 01350 and found to comply with the VOC requirements. California Specification 01350 is referenced by various green building standards and rating systems.

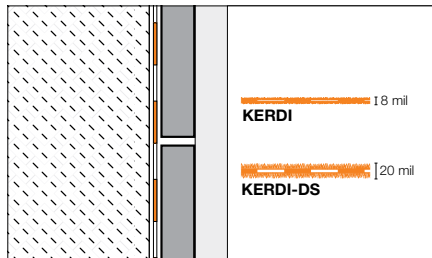

Note: 1 mil = 1 one-thousandth of an inch

Schluter®-KERDI				
Waterproofing membrane				
Item No.	Dimensions	\$ / ft ² *	\$ / Roll	
Roll width: 1 m - 3' 3"				
KERDI 200/5M	1 m x 5 m = 5 m ² - 3' 3" x 16' 5" = 54 ft ²	2.40	129.62	
KERDI 200/7M	1 m x 7 m = 7 m ² - 3' 3" x 23' = 75 ft ²	2.37	177.53	
KERDI 200/10M	1 m x 10 m = 10 m ² - 3' 3" x 33' = 108 ft ²	2.33	251.69	
KERDI 200/20M	1 m x 20 m = 20 m ² - 3' 3" x 65' 7" = 215 ft ²	2.24	481.00	
KERDI 200	1 m x 30 m = 30 m ² - 3' 3" x 98' 5" = 323 ft ²	2.10	678.15	
Roll width: 2 m - 6' 7"				
KERDI 200200/15M	2 m x 15 m = 30 m ² - 6' 7" x 49' 2-1/2" = 323 ft ²	2.10	678.15	
KERDI 200200	2 m x 30 m = 60 m ² - 6' 7" x 98' 5" = 646 ft ²	2.01	1,299.31	

Schluter®-KERDI-DS				
Waterproofing membrane				
Item No.	Dimensions	\$ / ft ² *	\$ / Roll	
KERDI-DS	1 m x 30 m = 30 m ² - 3' 3" x 98' 5" = 323 ft ²	2.85	920.33	

* The price per square foot is for estimation purposes only. Please order using the price per roll.



Schluter®-SET, Schluter®-ALL-SET, and Schluter®-FAST-SET
See page 192



Schluter®-TROWEL
See page 196

Schluter®-KERDI-BAND

Schluter®-KERDI-BAND is a waterproofing strip used to seal butt joints and floor/wall connections with the Schluter®-KERDI, DITRA, and DITRA-HEAT membranes, as well as joints, corners, and fastener penetrations with the Schluter®-KERDI-BOARD building panels.

Note: 1 mil = 1 one-thousandth of an inch

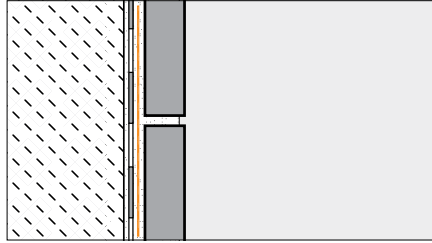

Schluter®-KERDI-BAND					
Waterproofing strip					
Item No.	Width	Length	Thickness	\$ / ft *	\$ / Roll
125 mm - 5" width					
KEBA 100/125/5M	125 mm - 5"	5 m - 16' 5"	4 mil	1.47	24.06
KEBA 100/125/10M	125 mm - 5"	10 m - 33'	4 mil	1.38	45.70
KEBA 100/125	125 mm - 5"	30 m - 98' 5"	4 mil	1.15	112.92
KEBA100/125/300	125 mm - 5"	300 m - 984' 3"	4 mil	1.03	1,016.39
185 mm - 7-1/4" width					
KEBA 100/185/5M	185 mm - 7-1/4"	5 m - 16' 5"	4 mil	1.92	31.51
KEBA 100/185	185 mm - 7-1/4"	30 m - 98' 5"	4 mil	1.59	156.11
250 mm - 10" width					
KEBA 100/250/5M	250 mm - 10"	5 m - 16' 5"	4 mil	2.39	39.27
KEBA 100/250	250 mm - 10"	30 m - 98' 5"	4 mil	2.04	200.73

* The price per foot is for estimation purposes only. Please order using the price per roll.

Schluter®-KERDI-KERECK-F

Schluter®-KERDI-KERECK-F are preformed, seamless corners made of Schluter®-KERDI for waterproofing inside and outside corners.

Note: 1 mil = 1 one-thousandth of an inch

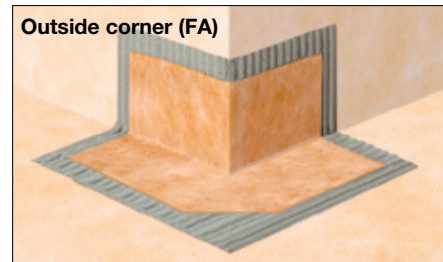
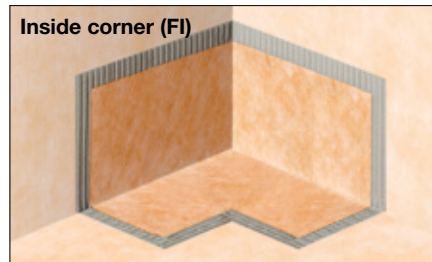

Schluter®-KERDI-KERECK-F			
Waterproofing for 90° corners			
Item No.	Thickness	Packaging	\$ / Package
KERECK/FI 2	4 mil	2 Inside corners	18.56
KERECK/FA 2	4 mil	2 Outside corners	18.56
Waterproofing for 135° corners			
KERECK 135 FI 2	4 mil	2 Inside corners	20.57

Schluter®-KERDI-KERECK-F			
Waterproofing for 90° corners			
Item No.	Thickness	Packaging	\$ / Package
KERECK/FI 10	4 mil	10 Inside corners	88.38
KERECK/FA 10	4 mil	10 Outside corners	88.38
Waterproofing for 135° corners			
KERECK 135 FI 10	4 mil	10 Inside corners	97.68



Schluter®-KERDI-KERS-B

Schluter®-KERDI-KERS-B are preformed, seamless corners for waterproofing 135° angles between triangular shower benches and walls or for curb corners in neo-angle shower applications.

Note: 1 mil = 1 one-thousandth of an inch



Schluter®-KERDI-KERS-B				
Waterproofing corners				
Item No.	Thickness	Description	Packaging	\$ / Package
KERECK 135 FI 2	4 mil	Inside corner, 135°	2 units	20.57
KERECK 135 FI 10	4 mil	Inside corner, 135°	10 units	97.68
KERSB 135 K LR	4 mil	Outside corner, 135°	1 right and 1 left	43.39
KERSB 135 K 5LR	4 mil	Outside corner, 135°	5 right and 5 left	206.03
KERSB 135 K	4 mil	Bench/neo-angle corner kit	1 right and 1 left 135° outside corner, and 2 135° inside corners	63.93

Schluter®-KERDI-KERS

Schluter®-KERDI-KERS are preformed, seamless corners made of Schluter®-KERDI for waterproofing floor/wall/shower base connections in curbless shower applications where the Schluter®-KERDI-LINE linear drain is installed adjacent to the wall.

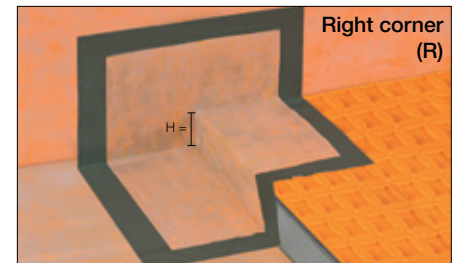
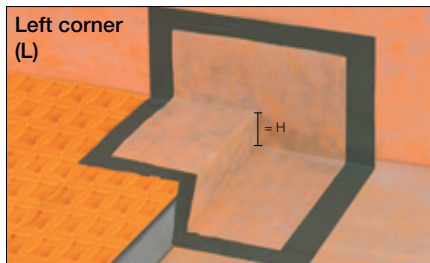

Schluter®-KERDI-KERS				
Waterproofing for corners				
Item No.	H = mm - in.	Thickness	Description	\$ / Unit
KERS 20 L	20 - 3/4	4 mil	Left inside corner	24.96
KERS 28 L	28 - 1-3/32	4 mil	Left inside corner	24.96
KERS 20 R	20 - 3/4	4 mil	Right inside corner	24.96
KERS 28 R	28 - 1-3/32	4 mil	Right inside corner	24.96

Schluter®-KERDI-SEAL-PS/-MV

Schluter®-KERDI-SEAL-PS/-MV prefabricated seals are cut sections of the Schluter®-KERDI waterproofing membrane designed to seal protrusions through the Schluter®-KERDI or Schluter®-DITRA/DITRA-XL, as well as Schluter®-KERDI-BOARD building panels. Schluter®-KERDI-SEAL-PS and -MV feature overmolded rubber gaskets and are used to seal pipe protrusions and protect moisture-sensitive solid backing panels at the mixing valve.

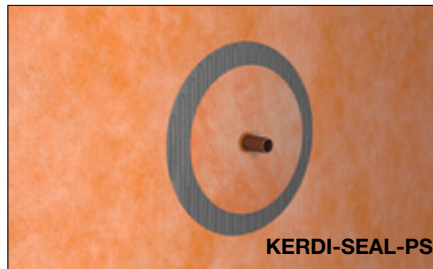

KERDI-SEAL-PS

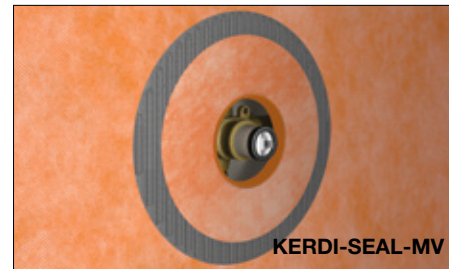

KERDI-SEAL-MV

Note: 1 mil = 1 one-thousandth of an inch

Schluter®-KERDI-SEAL-PS

Pipe seal with overmolded rubber gasket

Item No.	Pipe nipple opening diam.	Thickness	Packaging	\$ / Package
KMS172/12	12.5 mm - 1/2"	4 mil	1 unit	9.15
KMS172/20	20 mm - 3/4"	4 mil	1 unit	9.15
KMS10172/12	12.5 mm - 1/2"	4 mil	10 units	82.30
KMS10172/20	20 mm - 3/4"	4 mil	10 units	82.30

Schluter®-KERDI-SEAL-MV

Mixing valve seal with overmolded rubber gasket

Item No.	Mixing valve opening diam.	Thickness	Packaging	\$ / Package
KMSMV235/114	114 mm - 4-1/2"	4 mil	1 unit	10.55
KMSMV10235/114	114 mm - 4-1/2"	4 mil	10 units	94.97

Schluter®-KERDI-KM

Schluter®-KERDI-KM prefabricated seal is cut sections of the Schluter®-KERDI waterproofing membrane designed to seal protrusions through the KERDI or Schluter®-DITRA/DITRA-XL membranes. KERDI-KM is designed to be used in conjunction with Schluter®-KERDI-FIX or equivalent sealant to seal around pipes or other similar elements.

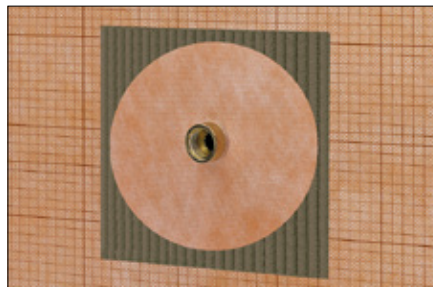

Schluter®-KERDI-KM

Pipe seal

Item No.	Pipe nipple opening diam.	Thickness	Packaging	\$ / Package
KM5117/22	22 mm - 7/8"	4 mil	5 units	10.77



Schluter®-KERDI-DRAIN

Point drain with integrated bonding flange

Schluter®-KERDI-DRAIN is a shower drain with an integrated bonding flange that provides a large contact area for a secure connection to the KERDI waterproofing membrane at the top of the assembly. The grate assembly can be seamlessly adjusted to the thickness and layout of the ceramic tile or stone covering. KERDI-DRAIN is available with several grate designs, including a frameless tileable covering support, and offered in nine TRENDLINE colors to match with Schluter®-SHELF, trim profiles, and fixtures.





Schluter®-KERDI-DRAIN and Schluter®-KERDI-DRAIN-H

Schluter®-KERDI-DRAIN and **KERDI-DRAIN-H** are floor drains with an integrated bonding flange that provides a large contact area for a secure connection to the Schluter®-KERDI waterproofing membrane at the top of the assembly. Both KERDI-DRAIN and KERDI-DRAIN-H are appropriate for both mortar bed and Schluter®-KERDI-SHOWER-T/-TS/-TT shower tray applications. The bonding flange is sloped to simplify installation of the mortar bed.

The KERDI-DRAIN flange provides a vertical connection to the drain pipe and is available in ABS or PVC with 2" or 3" (50 or 75 mm) outlet, and stainless steel with a 2" or 3" (50 or 75 mm) no-hub outlet or 2" (50 mm) threaded outlet.

The KERDI-DRAIN-H flange provides a horizontal connection to the drain pipe and is available in ABS or PVC with a 2" (50 mm) outlet. It is ideal for applications where the use of a vertical connection to the drain pipe is not possible or practical (e.g., suspended or post-tension concrete floors, basement slabs, or wood floor installations where relocating the hole in the floor is not practical). The horizontal outlet allows the positioning of the drain in the desired area regardless of drain pipe location.

A compensation board is available for use with KERDI-DRAIN-H in conjunction with the KERDI-SHOWER-T/-TS/-TT shower trays.

KERDI-DRAIN and KERDI-DRAIN-H feature a fully adjustable grate (available in stainless steel and anodized aluminum in various finishes) that accommodates a wide range of tile thicknesses: 1/4" (6 mm) to 1-1/4" (32 mm); or a tileable covering support that accommodates any tile thickness and creates a virtually invisible drainage line. The grate assembly allows lateral and tilt adjustment as well. Please note that grate assemblies used with the plastic KERDI-DRAIN featuring 3" (75 mm) outlets only allow vertical and tilt adjustment (no lateral adjustment). 6" (150 mm)-square stainless steel covers are also available for installations where KERDI-DRAIN or KERDI-DRAIN-H are to be used in a cleanout application.

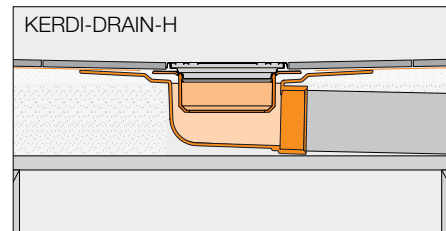
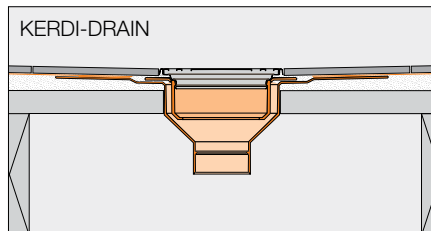
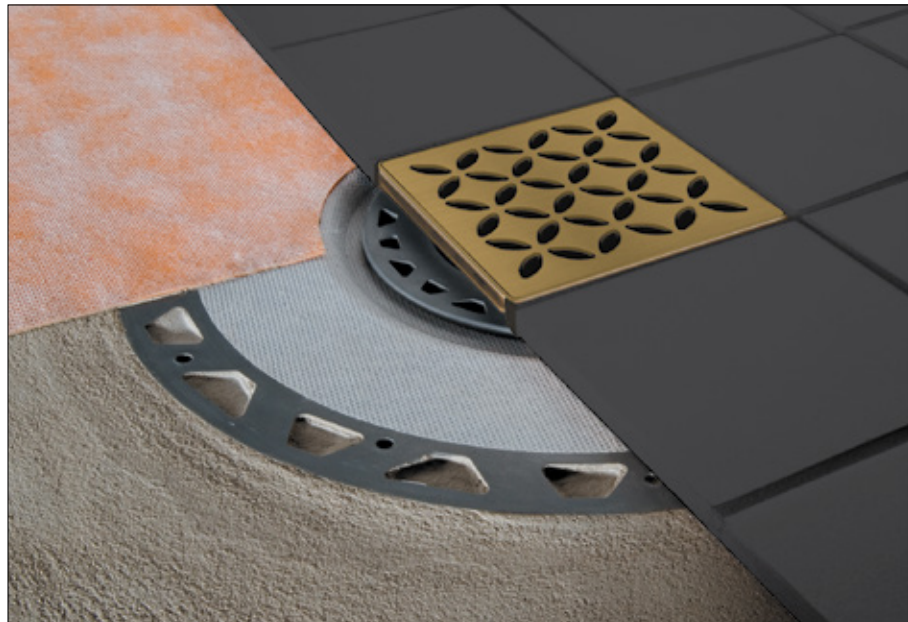



Selecting your Schluter®-KERDI-DRAIN

Schluter®-KERDI-DRAIN flanges and grates are sold separately.

1 Select your grate from pages 134 - 137.

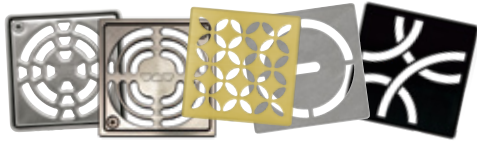

2 Select the flange appropriate for your application from the tables on pages 138 - 143.



i

- When using a flange with a 3" (75 mm) outlet, a 6" (150 mm) grate is recommended.
- When using the KERDI-DRAIN-F flange, the 4" (100 mm) tileable grate and 6" (150 mm) round and square grates are not suitable.
- When using the KERDI-DRAIN-A flange with 5-1/2" (140 mm) adaptor ring, the 6" (150 mm) round and square grates are not suitable.

Schluter®-KERDI-DRAIN - Listings and Certifications									
Flanges	Grates	Grate - 4" (100 mm)				STYLE PURE, CURVE and FLORAL Stainless steel (All finishes)	Grate - 6" (150 mm)		
		CLASSIC Stainless steel (All finishes except EOB)	CLASSIC Stainless steel EOB	CONTOUR Anodized aluminum (All finishes)	TILE		Stainless steel		
							Square 6E	Round 6RE	Cover 6CE
2" (50 mm) PVC		1	-	1	1	1	1	2	
2" (50 mm) ABS		1	-	1	1	1	1	2	
2" (50 mm) PVC Horizontal		1	-	1	1	1	1	2	
2" (50 mm) ABS Horizontal		1	-	1	1	1	1	2	
2" (50 mm) Stainless steel		1	-	1	1	1	1	2	
2" (50 mm) Stainless steel Threaded		1	-	1	1	1	1	2	
3" (75 mm) PVC		-	-	-	-	1	1	2	
3" (75 mm) ABS		-	-	-	-	1	1	2	
3" (75 mm) Stainless steel		-	-	-	-	1	1	2	
5-1/2" (140 mm) Adaptor		3	-	3	3	-	-	-	
7-1/2" (191 mm) Adaptor		-	-	-	-	3	3	-	

Various configurations of KERDI-DRAIN are listed by ICC-ES (Report No. PMG-1204), UPC® and CSA as shown in the table above.

1 - Listed by ICC-ES (Report No. PMG-1204), UPC® and CSA.

2 - Listed by CSA

3 - Listed by ICC-ES (Report No. PMG-1204) and UPC®

For copies of these documents, please contact Schluter®-Systems at 800-472-4588 or by email at info@schluter.com. Links to the documents can also be accessed at Schluter.com.



GRATES FOR USE WITH FLANGES WITH 2" (50 MM) OUTLET

Schluter®-KERDI-DRAIN-STYLE - Metallic finishes

Stainless Steel





PURE		100 mm - 4"
Grate finish	Item No.	\$ / Unit
Brushed stainless steel (EB)	KDIF4 GRK EB D8	104.59
Brushed nickel (EBT)	KDIF4 GRK EBT D8	164.85
Brushed vintage gold (EBVG)	KDIF4 GRK EBVG D8	164.85
Brushed classic gold (EBCG)	KDIF4 GRK EBCG D8	164.85

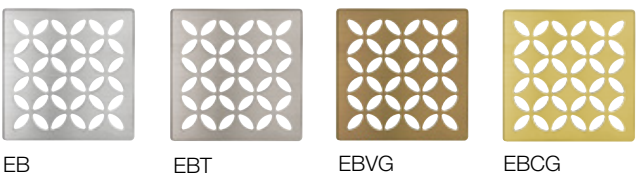

CURVE		100 mm - 4"
Grate finish	Item No.	\$ / Unit
Brushed stainless steel (EB)	KDIF4 GRK EB D6	104.59
Brushed nickel (EBT)	KDIF4 GRK EBT D6	164.85
Brushed vintage gold (EBVG)	KDIF4 GRK EBVG D6	164.85
Brushed classic gold (EBCG)	KDIF4 GRK EBCG D6	164.85



FLORAL		100 mm - 4"
Grate finish	Item No.	\$ / Unit
Brushed stainless steel (EB)	KDIF4 GRK EB D5	104.59
Brushed nickel (EBT)	KDIF4 GRK EBT D5	164.85
Brushed vintage gold (EBVG)	KDIF4 GRK EBVG D5	164.85
Brushed classic gold (EBCG)	KDIF4 GRK EBCG D5	164.85

Contents	
	1x Grate and frame
	1x Height adjustment collar
	1x Lateral adjustment ring



GRATES FOR USE WITH FLANGES WITH 2" (50 MM) OUTLET

Schluter®-KERDI-DRAIN-STYLE - TRENDLINE

Stainless Steel

PURE 100 mm - 4"		
Grate finish	Item No.	\$ / Unit
Matte white (MBW)	KDIF4 GRK MBW D8	164.85
Ivory (TSI)	KDIF4 GRK TSI D8	164.85
Greige (TSBG)	KDIF4 GRK TSBG D8	164.85
Cream (TSC)	KDIF4 GRK TSC D8	164.85
Bronze (TSOB)	KDIF4 GRK TSOB D8	164.85
Stone grey (TSSG)	KDIF4 GRK TSSG D8	164.85
Pewter (TSG)	KDIF4 GRK TSG D8	164.85
Dark anthracite (TSDA)	KDIF4 GRK TSDA D8	164.85
Matte black (MGS)	KDIF4 GRK MGS D8	164.85

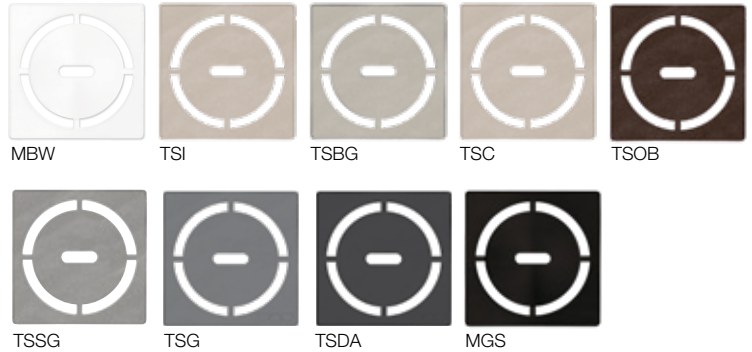

CURVE 100 mm - 4"		
Grate finish	Item No.	\$ / Unit
Matte white (MBW)	KDIF4 GRK MBW D6	164.85
Ivory (TSI)	KDIF4 GRK TSI D6	164.85
Greige (TSBG)	KDIF4 GRK TSBG D6	164.85
Cream (TSC)	KDIF4 GRK TSC D6	164.85
Bronze (TSOB)	KDIF4 GRK TSOB D6	164.85
Stone grey (TSSG)	KDIF4 GRK TSSG D6	164.85
Pewter (TSG)	KDIF4 GRK TSG D6	164.85
Dark anthracite (TSDA)	KDIF4 GRK TSDA D6	164.85
Matte black (MGS)	KDIF4 GRK MGS D6	164.85

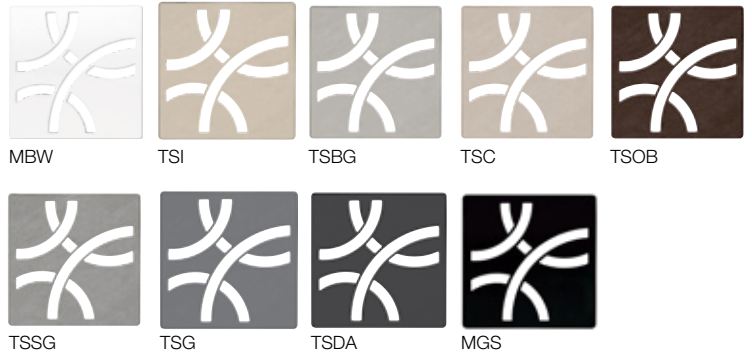

FLORAL 100 mm - 4"		
Grate finish	Item No.	\$ / Unit
Matte white (MBW)	KDIF4 GRK MBW D5	164.85
Ivory (TSI)	KDIF4 GRK TSI D5	164.85
Greige (TSBG)	KDIF4 GRK TSBG D5	164.85
Cream (TSC)	KDIF4 GRK TSC D5	164.85
Bronze (TSOB)	KDIF4 GRK TSOB D5	164.85
Stone grey (TSSG)	KDIF4 GRK TSSG D5	164.85
Pewter (TSG)	KDIF4 GRK TSG D5	164.85
Dark anthracite (TSDA)	KDIF4 GRK TSDA D5	164.85
Matte black (MGS)	KDIF4 GRK MGS D5	164.85

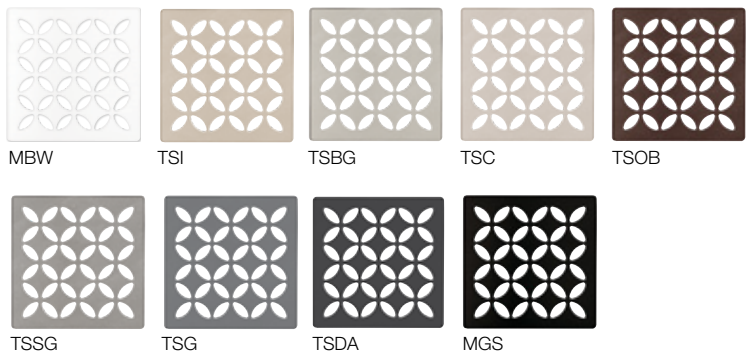

Contents



1x
Grate and frame



1x
Height adjustment collar



1x
Lateral adjustment ring



GRATES FOR USE WITH FLANGES WITH 2" (50 MM) OUTLET

Schluter®-KERDI-DRAIN

Stainless Steel

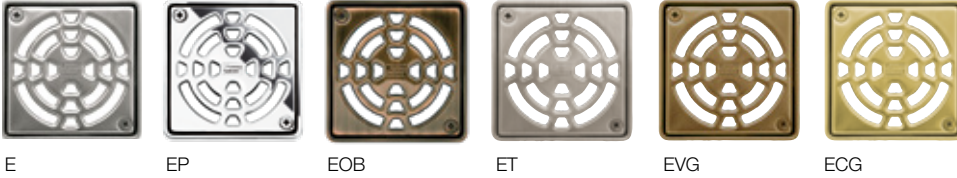



CLASSIC		100 mm - 4"		
Grate finish	1 UNIT		10-PACKS*	
	Item No.	\$ / Unit	Item No.	\$ / 10-Pack
Stainless steel (E)	KD4 GRK E	64.12	KD4 GRK E 10	577.00
Chrome (EP)	KD4 GRK EP	64.12	-	-
Oil-rubbed bronze (EOB)	KD4 GRK EOB	89.94	-	-
Nickel (ET)	KD4 GRK ET	103.80	-	-
Vintage gold (EVG)	KD4 GRK EVG	103.80	-	-
Classic gold (ECG)	KD4 GRK ECG	103.80	-	-

*Note: 10-packs are packaged in bulk, not individually boxed.

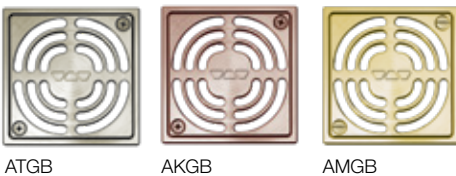
Anodized Aluminum



CONTOUR		100 mm - 4"	
Grate finish	Item No.	\$ / Unit	
Brushed nickel (ATGB)	KD4 GRK ATGB	89.94	
Brushed copper (AKGB)	KD4 GRK AKGB	89.94	
Brushed brass (AMGB)	KD4 GRK AMGB	89.94	

Contents	
	1x Grate and frame
	1x Height adjustment collar
	1x Lateral adjustment ring

Tileable Grate



TILE		100 mm - 4"	
Grate finish	Item No.	\$ / Unit	
TILE	KD4 GRK ECS	64.12	

Contents	
	1x Tileable covering support
	1x Spacer
	1x Lateral adjustment ring



The tileable grate is not suitable for use with the KERDI-DRAIN-F flange.



GRATES FOR USE WITH FLANGES WITH 2" (50 MM) or 3" (75 MM) OUTLET



Schluter®-KERDI-DRAIN

Stainless Steel



CLASSIC SQUARE		150 mm - 6"
Grate finish	Item No.	\$ / Unit
Stainless steel (E)	KD6 GRK E	85.98

CLASSIC ROUND		150 mm - 6"
Grate finish	Item No.	\$ / Unit
Stainless steel (E)	KD6 GRK RE	85.98

Contents			
	<p>1x Grate and frame with integrated height adjustment collar</p>		<p>1x Lateral adjustment ring</p>



The 6" (150 mm) grates are not suitable for use with the KERDI-DRAIN-F flange and the KERDI-DRAIN-A flange with 5-1/2" (140 mm) adaptor ring.





KERDI-DRAIN PURE grate in greige (page 135)





FLANGE KITS WITH SEALS AND CORNERS

Schluter®-KERDI-DRAIN

Schluter®-KERDI-DRAIN - Flanges with vertical outlet					
					
		ABS	PVC	Stainless steel	
Material	Outlet	1 UNIT		10-PACKS*	
		Item No.	\$ / Unit	Item No.	\$ / 10-Pack
ABS	50 mm - 2"	KD2 FLK ABS	90.73	KD2 FLK ABS 10	816.59
ABS	75 mm - 3"	KD3 FLK ABS	102.56	-	-
PVC	50 mm - 2"	KD2 FLK PVC	90.73	KD2 FLK PVC 10	816.59
PVC	75 mm - 3"	KD3 FLK PVC	102.56	-	-
Stainless Steel	50 mm - 2" no-hub	KD2 FLK E	260.43	-	-
Stainless Steel	50 mm - 2" threaded	KD2 FLK ETH	289.76	-	-
Stainless Steel	75 mm - 3" no-hub	KD3 FLK E	260.43	-	-





*Note: 10-packs are packaged in bulk, not individually boxed.

Schluter®-KERDI-DRAIN-H

Schluter®-KERDI-DRAIN-H - Flanges with horizontal outlet			
			
		ABS	PVC
Material	Outlet	1 UNIT	
		Item No.	\$ / Unit
ABS	50 mm - 2"	KDH2 FLK ABS	90.73
PVC	50 mm - 2"	KDH2 FLK PVC	90.73



Schluter®-KERDI-SHOWER-CB
Height Compensation Board
See page 160

Additional components included with all flanges			
	4x Inside corners		2x Outside corners
	1x Pipe seal (20 mm - 3/4")		1x Mixing valve seal (114 mm - 4-1/2")

Also included with stainless steel flanges	
	1x KERDI-FIX sealing and bonding compound (100 ml - 3.38 fl oz) ⚠ WARNING: Reproductive Harm www.P65Warnings.ca.gov

i
When using a flange with 3" (75 mm) outlet, a 6" (150 mm) grate is recommended.



FLANGE MEASUREMENTS

Schluter®-KERDI-DRAIN

ABS or PVC

		50 mm - 2" drain outlet	75 mm - 3" drain outlet
	A	300 mm - 11-13/16"	300 mm - 11-13/16"
	B	115.2 mm - 4-17/32"	115.2 mm - 4-17/32"
	C	68.6 mm - 2-45/64"	100 mm - 3-15/16"
	D	60.5 mm - 2-3/8"	88.8 mm - 3-1/2"
	E	100 mm - 3-15/16"	100 mm - 3-15/16"
	F	40.6 mm - 1-39/64"	50.8 mm - 2"
	G	22.5 mm - 7/8"	38.1 mm - 1-1/2"

Stainless steel

		50 mm - 2" no-hub outlet	75 mm - 3" no-hub outlet
	A	250 mm - 9-27/32"	250 mm - 9-27/32"
	B	115.4 mm - 4-1/2"	114 mm - 4-1/2"
	C	61.3 mm - 2-13/32"	87.4 mm - 3-7/16"
	D	60.6 mm - 2-13/32"	84.2 mm - 3-5/16"
	E	85 mm - 3-11/32"	87.4 mm - 3-7/16"
	F	21 mm - 53/64"	29.4 mm - 1-5/32"

Schluter®-KERDI-DRAIN-H

ABS or PVC

		50 mm - 2" horizontal drain outlet
	A	300 mm - 11-13/16"
	B	118.3 mm - 4-21/32"
	C	69.5 mm - 2-47/64"
	D	60.5 mm - 2-3/8"
	E	85.7 mm - 3-3/8"
	F	27 mm - 1-1/16"

ADAPTOR KITS — 5-1/2" or 7-1/2" (140 or 191 mm)

Schluter®-KERDI-DRAIN-A

Schluter®-KERDI-DRAIN-A ADAPTOR KITS are used to convert traditional clamping ring drains to integrated bonding flange drains when removal of the clamping ring drain is not practical. A stainless steel adaptor ring with an overmolded rubber gasket replaces the clamping ring and is sealed to the existing drain body using Schluter®-KERDI-FIX. The bonding flange then slides into the adaptor ring and seals against the rubber gasket. Adaptor kits are suitable for both mortar bed and Schluter®-KERDI-SHOWER-T/-TS/-TT shower tray applications.

NEW! The 5-1/2" (140 mm) adaptor kit features an improved configuration!

- The ring has been modified to make it compatible with a larger variety of clamping ring drains.
- The flange now accommodates the tileable grate.

140 mm - 5-1/2" adaptor kit							
 <p>140 mm 5-1/2"</p> <p>Also included: Height adjustment collar for KERDI-DRAIN grate</p>	<table border="1"> <thead> <tr> <th colspan="2">1 UNIT</th> </tr> <tr> <th>Item No.</th> <th>\$ / Unit</th> </tr> </thead> <tbody> <tr> <td>KDAM5 FLK ABS</td> <td>90.73</td> </tr> </tbody> </table>	1 UNIT		Item No.	\$ / Unit	KDAM5 FLK ABS	90.73
	1 UNIT						
Item No.	\$ / Unit						
KDAM5 FLK ABS	90.73						
	<table border="1"> <thead> <tr> <th colspan="2">10-PACK*</th> </tr> <tr> <th>Item No.</th> <th>\$ / 10-Pack</th> </tr> </thead> <tbody> <tr> <td>KDAM5 FLK ABS 10</td> <td>816.59</td> </tr> </tbody> </table>	10-PACK*		Item No.	\$ / 10-Pack	KDAM5 FLK ABS 10	816.59
10-PACK*							
Item No.	\$ / 10-Pack						
KDAM5 FLK ABS 10	816.59						

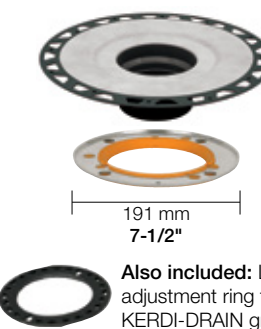
191 mm - 7-1/2" adaptor kit							
 <p>191 mm 7-1/2"</p> <p>Also included: Lateral adjustment ring for KERDI-DRAIN grate</p>	<table border="1"> <thead> <tr> <th colspan="2">1 UNIT</th> </tr> <tr> <th>Item No.</th> <th>\$ / Unit</th> </tr> </thead> <tbody> <tr> <td>KDA7 FLK ABS</td> <td>124.43</td> </tr> </tbody> </table>	1 UNIT		Item No.	\$ / Unit	KDA7 FLK ABS	124.43
	1 UNIT						
Item No.	\$ / Unit						
KDA7 FLK ABS	124.43						

*Note: 10-packs are packaged in bulk, not individually boxed.

Additional components included

 4x Inside corners	 2x Outside corners	 1x Pipe seal (20 mm - 3/4")	 1x Mixing valve seal (114 mm - 4-1/2")	 1x KERDI-FIX sealing and bonding compound (100 ml - 3.38 fl oz)
---	--	--	---	--

WARNING:
Reproductive Harm
www.P65Warnings.ca.gov

Flange and adaptor ring measurements - 5-1/2"

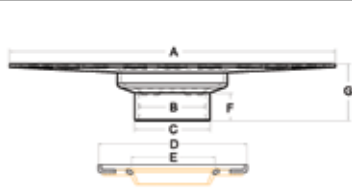
	A	300 mm - 11-13/16"
	B	58.7 mm - 2-5/16"
	C	64.1 mm - 2-17/32"
	D	139.7 mm - 5-1/2"
	E	68.2 mm - 2-11/16"
	F	25.2 mm - 1"
	G	57.8 mm - 2-9/32"

Flange and adaptor ring measurements - 7-1/2"

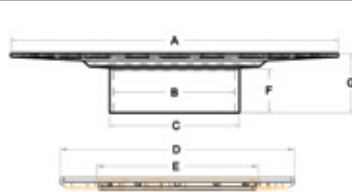
	A	300 mm - 11-13/16"
	B	111.8 mm - 4-13/32"
	C	118.9 mm - 4-11/16"
	D	191 mm - 7-1/2"
	E	130 mm - 5-7/64"
	F	77.8 mm - 3-1/16"
	G	92.4 mm - 3-41/64"



The 6" (150 mm) round/square grates are not compatible with the flange with 5-1/2" (140 mm) adaptor ring.



NEW! Schluter®-KERDI-SHOWER-CB

A compensation board used to accommodate the adaptor ring height when installing the KERDI-DRAIN-A in conjunction with the KERDI-SHOWER-T/-TS/-TT shower trays is now available. See page 160.



FLANGE KITS WITHOUT SEALS AND CORNERS

Schluter®-KERDI-DRAIN

Schluter®-KERDI-DRAIN - Flanges with vertical outlet



ABS



PVC



Stainless steel

Material	Outlet	1 UNIT		10-PACKS*	
		Item No.	\$ / Unit	Item No.	\$ / 10-Pack
ABS	50 mm - 2"	KD2/ABS/FL	31.60	KD2/ABS/FL10	284.31
ABS	75 mm - 3"	KD3/ABS/FL	43.43	-	-
PVC	50 mm - 2"	KD2/PVC/FL	31.60	KD2/PVC/FL10	284.31
PVC	75 mm - 3"	KD3/PVC/FL	43.43	-	-
Stainless Steel	50 mm - 2" no-hub	KD2/E/FL	213.97	KD2/E/FL10	1,747.88
Stainless Steel	50 mm - 2" threaded	KD2/ETH/FL	217.95	-	-
Stainless Steel	75 mm - 3" no-hub	KD3/E/FL	213.97	-	-

***Notes:**

- 10-packs are packaged in bulk, not individually boxed.
- The stainless steel flange 10-pack does not include KERDI-FIX.

Also included with stainless steel flanges



1x

KERDI-FIX
sealing and bonding compound (100 ml - 3.38 fl oz)
(not included with 10-pack)

⚠ WARNING: Reproductive Harm
www.P65Warnings.ca.gov

i

When using a flange with 3" (75 mm) outlet,
a 6" (150 mm) grate is recommended.

Schluter®-KERDI-DRAIN-H

Schluter®-KERDI-DRAIN-H - Flanges with horizontal outlet



ABS



PVC

Material	Outlet	Item No.	\$ / Unit
ABS	50 mm - 2"	KDH2/ABS/FL	31.60
PVC	50 mm - 2"	KDH2/PVC/FL	31.60











COMPLETE DRAIN KITS

Schluter®-KERDI-DRAIN

Schluter®-KERDI-DRAIN Kit					
Flange		Grate - 100 mm - 4"		Item No.	\$ / Unit
Material	Outlet	Grate Design	Grate Finish		
ABS	50 mm - 2"	CLASSIC	Stainless steel (E)	KD2/ABS/E	154.84
PVC	50 mm - 2"	CLASSIC	Stainless steel (E)	KD2/PVC/E	154.84









Contents

	1x Flange		1x Grate and frame		1x Height adjustment collar		1x Lateral adjustment ring
	4x Inside corners		2x Outside corners		1x Pipe seal (20 mm - 3/4")		1x Mixing valve seal (114 mm - 4-1/2")

Schluter®-KERDI-DRAIN-A

Schluter®-KERDI-DRAIN-A Adaptor Kit – 140 mm - 5-1/2"				
Adaptor	Grate - 100 mm - 4"		Item No.	\$ / Unit
Ring Size	Grate Design	Grate Finish		
140 mm - 5-1/2"	CLASSIC	Stainless steel (E)	KDAM5 ABS E	154.84

Contents

	1x Flange		1x Grate and frame		1x Height adjustment collar		1x Adaptor ring
	4x Inside corners		2x Outside corners		1x Pipe seal (20 mm - 3/4")		1x Mixing valve seal (114 mm - 4-1/2")
	1x KERDI-FIX sealing and bonding compound (100 ml - 3.38 fl oz)	⚠ WARNING: Reproductive Harm – www.P65Warnings.ca.gov					



FLOOR DRAIN WITH INTEGRATED KERDI COLLAR

Schluter®-KERDI-DRAIN-F

Schluter®-KERDI-DRAIN-F is a floor drain specifically designed to allow connections to Schluter®-DITRA and DITRA-HEAT uncoupling membranes in floor applications. The drain body is available in polypropylene or stainless steel, each with a laminated Schluter®-KERDI collar that ensures a simple connection to the uncoupling membrane on the floor and at wall transitions. KERDI-DRAIN-F features a flat, narrow bonding flange to allow for placement against walls or in corners. It can be combined with virtually any KERDI-DRAIN grate assembly, with the exception of the tileable grate and the 6" (150 mm) square and round grates. The grate assembly is sold separately, please refer to pages 134 to 136.

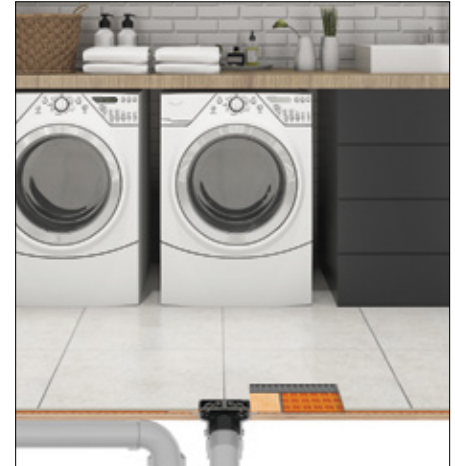



Schluter®-KERDI-DRAIN-F - Floor drain with narrow bonding flange and integrated KERDI collar

Polypropylene	Stainless steel with no-hub outlet	Stainless steel with threaded outlet
 <p>ABS and PVC couplings included</p> 		

Material	Outlet	Item No.	\$ / Unit
Polypropylene	50 mm - 2" NPT	KDF2FL	55.16
Stainless Steel	50 mm - 2" no-hub	KDF2EFL	250.79
Stainless Steel	50 mm - 2" threaded	KDF2ETHFL	279.11

Listed by ICC-ES (Report No. PMG-1204), UPC® and CSA.

Additional components included

 <p>1x Vertical height adjustment collar</p>	 <p>1x Construction cover</p>
--	---

i The tileable grate and the 6" (150 mm) round/square grates are not compatible with KERDI-DRAIN-F.

Drain measurements

Polypropylene 50 mm (2") outlet		Stainless steel 50 mm (2") no-hub outlet		Stainless steel 50 mm (2") threaded outlet	
A	268 mm - 10-9/16"	A	280 mm - 11-1/32"	A	280 mm - 11-1/32"
B	128 mm - 5-1/32"	B	139 mm - 5-15/32"	B	139 mm - 5-15/32"
C	101.1 mm - 3-31/32"	C	98 mm - 3-27/32"	C	98 mm - 3-27/32"
D	75.4 mm - 2-31/32"	D	77.2 mm - 3-1/32"	D	73.7 mm - 2-29/32"
E	3 mm - 1/8"	E	1.5 mm - 1/16"	E	1.5 mm - 1/16"



Schluter®-KERDI-DRAIN

6" SQUARE CLEAN OUT COVER

The **Schluter®-KERDI-DRAIN Clean Out Cover** is a 6" (150 mm) stainless steel cover available for installations where the KERDI-DRAIN bonding flange is to be used in a cleanout application. The KERDI-DRAIN bonding flange is sold separately.



Clean out cover 150 mm - 6"		
Item No.	Finish	\$ / Unit
KD-GR6C-E	Stainless steel	173.81

TAMPER PROOF SCREWS

Schluter®-KERDI-DRAIN Tamper Proof Screws are designed as a high security accessory for the KERDI-DRAIN. Ideal for loss prevention and anti-theft, these tamper proof screws are used in environments where tamper resistance is desired or required (e.g., healthcare or education facilities, etc.). Phillips head screws are included with the KERDI-DRAIN. The tamper-proof screws as well as the driver bit must be purchased separately.



Tamper proof screw and driver bit		
Item No.	Description	\$ / Unit
KD/TPSCRW	Tamper proof screw (1)	3.02
KD/TPWRCH	Driver bit (1)	14.73

STRAINER

The **Schluter®-KERDI-DRAIN Strainer** is a hair catcher customized to fit inside the KERDI-DRAIN flange to trap and collect hair. Simple to remove and clean, the hair catcher fits discreetly into the drain to prevent hair clogs that can lead to blocked pipes.

Note: The KERDI-DRAIN strainer is only suitable for use with flanges with 2" (50 mm) vertical outlets (ABS, PVC, and stainless steel with no-hub or threaded outlet).



Strainer for KERDI-DRAIN		
Item No.	Description	\$ / Unit
KD-STR	Strainer	3.36



Schluter® Linear Drains

Discover the benefits of Schluter® linear drains for an enhanced shower experience. Upgrade your tiled shower with the KERDI-LINE low-profile drain, ideal for curbless bathrooms. With various grate designs, including a tileable option, it's suitable for wall or intermediate locations in showers, steam rooms, and wet rooms. For a customizable solution, consider the KERDI-LINE-VARIO, which can be cut on-site for specific project needs. It comes in 4-foot and 8-foot lengths with four slim and modern grate designs.



**NEW! TRENDLINE finishes available for
KERDI-LINE (page 150) and KERDI-LINE-VARIO (page 156)**



NEW! KERDI-LINE-A

Convert a traditional clamping ring drain to a KERDI-LINE linear drain (page 152).



Schluter®-KERDI-LINE

The **Schluter®-KERDI-LINE** is a low profile linear floor drain specifically designed for bonded waterproofing assemblies. KERDI-LINE can be installed adjacent to walls or at intermediate locations in showers, wet rooms, and other applications that require waterproofing and drainage. The floor can be sloped on a single plane to KERDI-LINE, which enables the use of large-format tiles and creates interesting design opportunities.

The KERDI-LINE channel body is made of formed stainless steel 316L (1.4404 = V4A) and features a collar made of Schluter®-KERDI for a secure waterproof connection. The grate assembly is available in six design options:

- A - SOLID
- B - SQUARE
- D - TILE
- E - FLORAL
- F - CURVE
- G - PURE

If KERDI-LINE is placed at shower entrance, it is recommended that grate assembly A (SOLID), G (PURE), or D (TILE) is chosen and that the drainage openings span the maximum width of the shower entrance to limit potential overflow; secondary drainage (e.g., KERDI-DRAIN) may be required in the drying area.

Grate and frame assemblies A and B are made of stainless steel 316L (1.4404 = V4A) and available in brushed, chrome, or textured color-coated finishes. The brushed stainless steel grate assemblies can be adjusted for use with tile coverings from 1/8" to 1" (3 mm to 25 mm)-thick, and the chrome and color-coated versions can accommodate tiles from 1/8" to 9/16" (3 mm to 15 mm)-thick. The TILE grate (D) is frameless and can accommodate any thickness of tile covering. Grate and frame assemblies E, F and G (KERDI-LINE-STYLE) are available in brushed stainless steel and can accommodate tile coverings from 1/4" to 11/16" (6 - 18 mm)-thick.

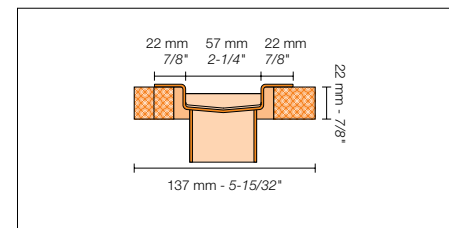
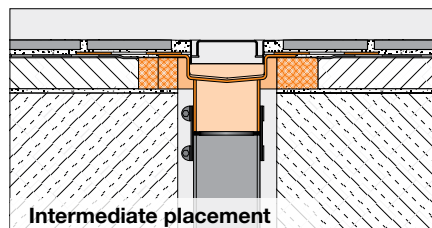
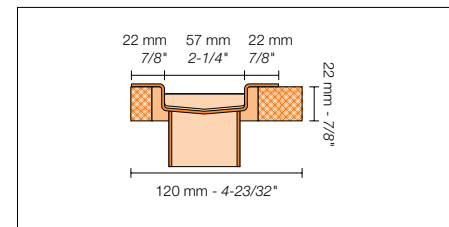
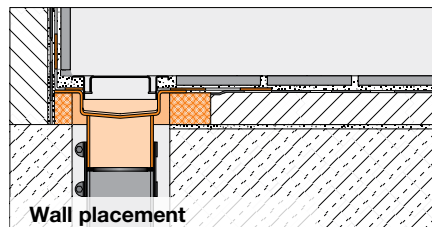
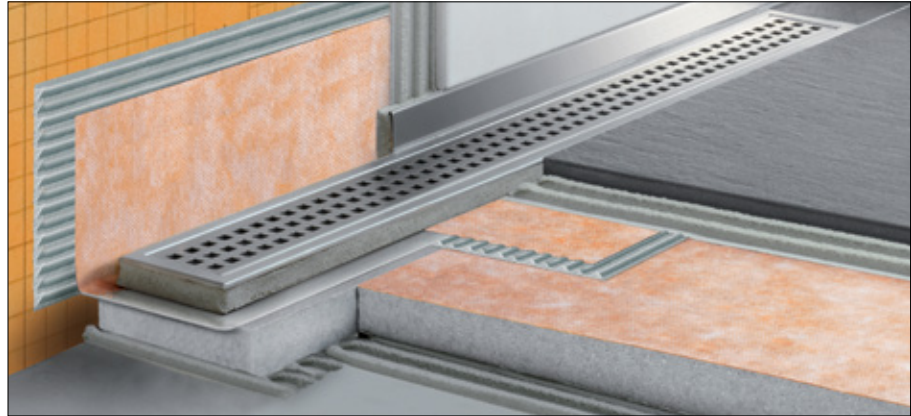

NEW!

- SOLID and SQUARE grate designs are now available in matte white and 7 TRENDLINE colors. See pages 149 & 150.
- KERDI-LINE-A adaptor ring converts a traditional clamping ring drain to a KERDI-LINE linear drain. See page 152.

Selecting your Schluter®-KERDI-LINE

Schluter®-KERDI-LINE channel bodies and grates are sold separately.

- 1 Select the appropriate channel body length and outlet placement from the tables on page 147.
- 2 Proceed to grate selection accordingly from pages 148 - 152, keeping in mind there are two frame height options for the SQUARE and SOLID grates in brushed stainless steel.



All configurations of KERDI-LINE are listed by ICC-ES (Report No. PMG-1204), UPC®, and CSA. For copies of these documents, please contact Schluter®-Systems at 800-472-4588 or by email at info@schluter.com. Links to the documents can also be accessed at Schluter.com.



Schluter®-KERDI-LINE

CHANNEL BODY

Contents

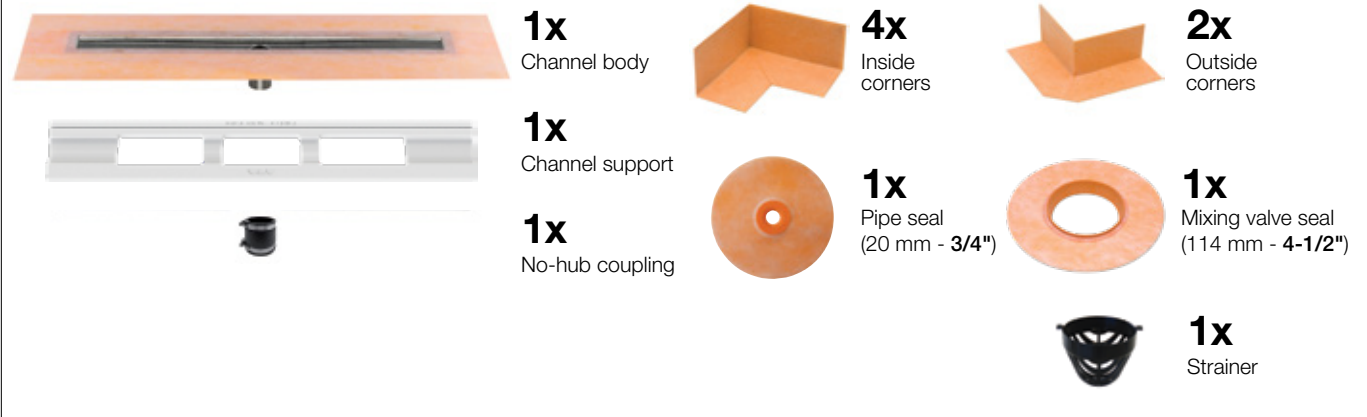

Channel body center outlet

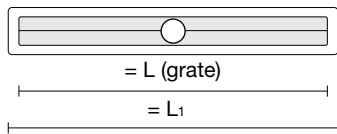

Channel body off-set outlet

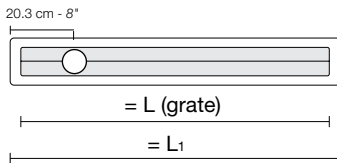

Schluter®-KERDI-LINE

Channel body - stainless steel - center outlet

L ₁ = cm - in.	L (grate) = cm - in.	Item No.	\$ / Unit
55 - 21-11/16	50 - 19-11/16	KL1V 60 E 50	367.57
65 - 25-5/8	60 - 23-5/8	KL1V 60 E 60	379.24
75 - 29-9/16	70 - 27-9/16	KL1V 60 E 70	411.93
85 - 33-1/2	80 - 31-1/2	KL1V 60 E 80	415.91
95 - 37-7/16	90 - 35-7/16	KL1V 60 E 90	434.37
105 - 41-3/8	100 - 39-3/8	KL1V 60 E 100	446.49
115 - 45-5/16	110 - 43-5/16	KL1V 60 E 110	455.81
125 - 49-1/4	120 - 47-1/4	KL1V 60 E 120	477.04
135 - 53-3/16	130 - 51-3/16	KL1V 60 E 130	578.07
145 - 57-1/8	140 - 55-1/8	KL1V 60 E 140	592.75
155 - 61-1/16	150 - 59-1/16	KL1V 60 E 150	606.93
165 - 64-15/16	160 - 62-15/16	KL1V 60 E 160	618.70
175 - 68-7/8	170 - 66-7/8	KL1V 60 E 170	628.37
185 - 72-13/16	180 - 70-13/16	KL1V 60 E 180	639.24

Channel body - stainless steel - off-set outlet

L ₁ = cm - in.	L (grate) = cm - in.	Item No.	\$ / Unit
75 - 29-9/16	70 - 27-9/16	KL1VO 60 E 70	416.99
85 - 33-1/2	80 - 31-1/2	KL1VO 60 E 80	421.04
95 - 37-7/16	90 - 35-7/16	KL1VO 60 E 90	440.30
105 - 41-3/8	100 - 39-3/8	KL1VO 60 E 100	468.71
115 - 45-5/16	110 - 43-5/16	KL1VO 60 E 110	487.70
125 - 49-1/4	120 - 47-1/4	KL1VO 60 E 120	510.87



Schluter®-KERDI-LINE-A

Linear drain adaptor kit
See page 152



Schluter®-KERDI-LINE

GRATE ASSEMBLY - BRUSHED STAINLESS STEEL

CONTENTS

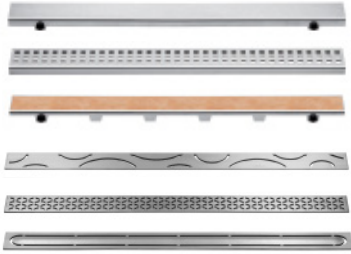

1x
Grate
6 design options:

- SOLID
- SQUARE
- TILE
- CURVE
- FLORAL
- PURE



1x
Grate frame with height adjustment spacers. See product tables for frame height options (not included with TILE grate).



1x
Grate removal tool





SOLID (A)

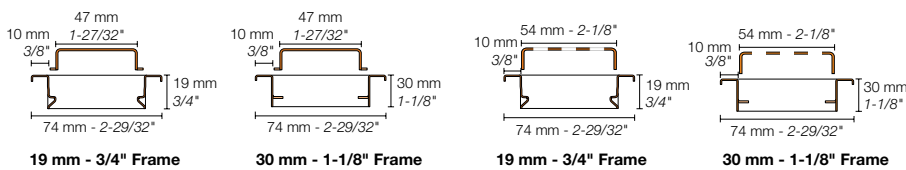

SQUARE (B)



Grate assemblies - Brushed stainless steel

Length = cm - in.	SOLID (A)		SQUARE (B)	
	Item No.	\$ / Unit	Item No.	\$ / Unit
 19 mm - 3/4" frame height for 3 mm to 15 mm - 1/8" to 9/16" -thick coverings				
50 - 19-11/16	KL1AR 19 EB 50	341.71	KL1B 19 EB 50	310.97
60 - 23-5/8	KL1AR 19 EB 60	351.51	KL1B 19 EB 60	316.90
70 - 27-9/16	KL1AR 19 EB 70	365.95	KL1B 19 EB 70	334.43
80 - 31-1/2	KL1AR 19 EB 80	375.41	KL1B 19 EB 80	340.50
90 - 35-7/16	KL1AR 19 EB 90	393.06	KL1B 19 EB 90	359.04
100 - 39-3/8	KL1AR 19 EB 100	416.57	KL1B 19 EB 100	369.41
110 - 43-5/16	KL1AR 19 EB 110	426.81	KL1B 19 EB 110	382.63
120 - 47-1/4	KL1AR 19 EB 120	434.52	KL1B 19 EB 120	389.90
130 - 51-3/16	KL1AR 19 EB 130	566.53	KL1B 19 EB 130	566.53
140 - 55-1/8	KL1AR 19 EB 140	594.93	KL1B 19 EB 140	594.93
150 - 59-1/16	KL1AR 19 EB 150	626.10	KL1B 19 EB 150	626.10
160 - 62-15/16	KL1AR 19 EB 160	666.59	KL1B 19 EB 160	666.59
170 - 66-7/8	KL1AR 19 EB 170	694.96	KL1B 19 EB 170	694.96
180 - 70-13/16	KL1AR 19 EB 180	734.78	KL1B 19 EB 180	734.78
 30 mm - 1-1/8" frame height for 13 mm to 25 mm - 1/2" to 1" -thick coverings				
50 - 19-11/16	KL1AR 30 EB 50	351.56	KL1B 30 EB 50	319.92
60 - 23-5/8	KL1AR 30 EB 60	363.56	KL1B 30 EB 60	327.78
70 - 27-9/16	KL1AR 30 EB 70	380.17	KL1B 30 EB 70	347.40
80 - 31-1/2	KL1AR 30 EB 80	391.06	KL1B 30 EB 80	354.65
90 - 35-7/16	KL1AR 30 EB 90	412.04	KL1B 30 EB 90	376.39
100 - 39-3/8	KL1AR 30 EB 100	437.67	KL1B 30 EB 100	388.11
110 - 43-5/16	KL1AR 30 EB 110	449.22	KL1B 30 EB 110	402.72
120 - 47-1/4	KL1AR 30 EB 120	456.93	KL1B 30 EB 120	409.97



Schluter®-KERDI-LINE

GRATE ASSEMBLY - CHROME

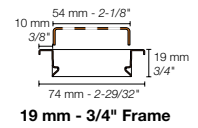
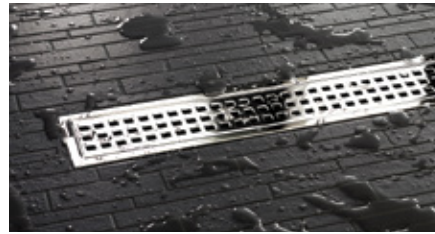
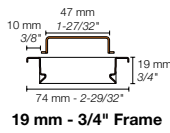
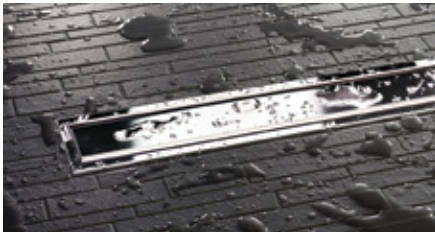

SOLID (A)

SQUARE (B)

Grate assemblies - Stainless steel - Chrome



19 mm - 3/4" frame height for
3 mm to 15 mm - 1/8" to 9/16" -thick coverings

Length = cm - in.	SOLID (A)		SQUARE (B)	
	Item No.	\$ / Unit	Item No.	\$ / Unit
50 - 19-11/16	KL1AR 19 EP 50	375.89	KL1B 19 EP 50	342.07
60 - 23-5/8	KL1AR 19 EP 60	386.66	KL1B 19 EP 60	348.61
70 - 27-9/16	KL1AR 19 EP 70	402.53	KL1B 19 EP 70	367.87
80 - 31-1/2	KL1AR 19 EP 80	412.94	KL1B 19 EP 80	374.54
90 - 35-7/16	KL1AR 19 EP 90	432.36	KL1B 19 EP 90	394.93
100 - 39-3/8	KL1AR 19 EP 100	458.24	KL1B 19 EP 100	406.35
110 - 43-5/16	KL1AR 19 EP 110	469.48	KL1B 19 EP 110	420.88
120 - 47-1/4	KL1AR 19 EP 120	477.98	KL1B 19 EP 120	428.89

GRATE ASSEMBLY - MATTE WHITE & MATTE BLACK

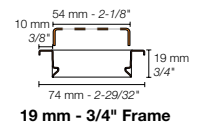
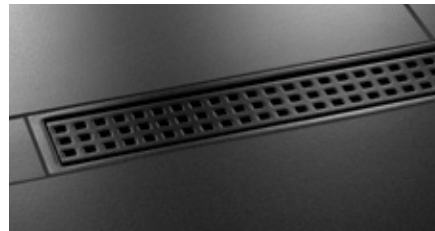
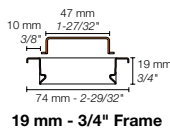
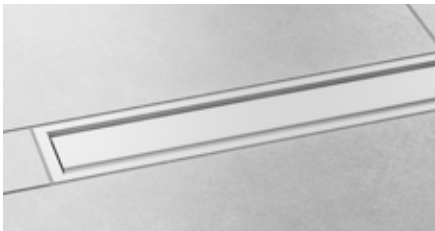

SOLID (A)

SQUARE (B)

Grate assemblies - Matte color-coated stainless steel



19 mm - 3/4" frame height for
3 mm to 15 mm - 1/8" to 9/16" -thick coverings

Length = cm - in.	SOLID (A)		SQUARE (B)	
	Item No.	\$ / Unit	Item No.	\$ / Unit
50 - 19-11/16	KL1AR 19 + color* 50	395.51	KL1B 19 + color* 50	359.92
60 - 23-5/8	KL1AR 19 + color* 60	406.84	KL1B 19 + color* 60	366.80
70 - 27-9/16	KL1AR 19 + color* 70	423.56	KL1B 19 + color* 70	387.07
80 - 31-1/2	KL1AR 19 + color* 80	434.50	KL1B 19 + color* 80	394.09
90 - 35-7/16	KL1AR 19 + color* 90	454.93	KL1B 19 + color* 90	415.56
100 - 39-3/8	KL1AR 19 + color* 100	482.14	KL1B 19 + color* 100	427.55
110 - 43-5/16	KL1AR 19 + color* 110	493.99	KL1B 19 + color* 110	442.85
120 - 47-1/4	KL1AR 19 + color* 120	502.93	KL1B 19 + color* 120	451.27
130 - 51-3/16	KL1AR 19 + color* 130	655.71	KL1B 19 + color* 130	655.71
140 - 55-1/8	KL1AR 19 + color* 140	688.57	KL1B 19 + color* 140	688.57
150 - 59-1/16	KL1AR 19 + color* 150	724.65	KL1B 19 + color* 150	724.65
160 - 62-15/16	KL1AR 19 + color* 160	771.52	KL1B 19 + color* 160	771.52
170 - 66-7/8	KL1AR 19 + color* 170	804.35	KL1B 19 + color* 170	804.35
180 - 70-13/16	KL1AR 19 + color* 180	850.44	KL1B 19 + color* 180	850.44

*Color Codes



* To complete the item number, add the color code (e.g., KL1B 19 MGS 50).

NEW!

Now available in Matte White.



GRATE ASSEMBLY - TRENDLINE COLORS

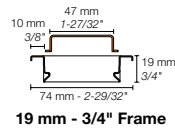
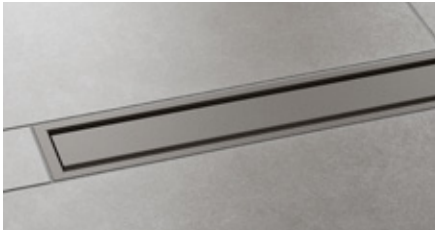

SOLID (A)

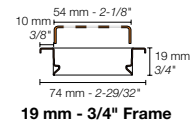
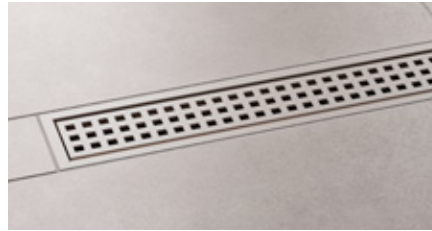

SQUARE (B)

Grate assemblies - Textured color-coated stainless steel

19 mm - 3/4" frame height for 3 mm to 15 mm - 1/8" to 9/16" -thick coverings

Length = cm - in.	SOLID (A)		SQUARE (B)	
	Item No.	\$ / Unit	Item No.	\$ / Unit
50 - 19-11/16	KL1AR 19 + color* 50	407.37	KL1B 19 + color* 50	370.72
60 - 23-5/8	KL1AR 19 + color* 60	419.05	KL1B 19 + color* 60	377.81
70 - 27-9/16	KL1AR 19 + color* 70	436.26	KL1B 19 + color* 70	398.68
80 - 31-1/2	KL1AR 19 + color* 80	447.54	KL1B 19 + color* 80	405.91
90 - 35-7/16	KL1AR 19 + color* 90	468.58	KL1B 19 + color* 90	428.02
100 - 39-3/8	KL1AR 19 + color* 100	496.61	KL1B 19 + color* 100	440.39
110 - 43-5/16	KL1AR 19 + color* 110	508.81	KL1B 19 + color* 110	456.14
120 - 47-1/4	KL1AR 19 + color* 120	518.02	KL1B 19 + color* 120	464.80
130 - 51-3/16	KL1AR 19 + color* 130	675.38	KL1B 19 + color* 130	675.38
140 - 55-1/8	KL1AR 19 + color* 140	709.23	KL1B 19 + color* 140	709.23
150 - 59-1/16	KL1AR 19 + color* 150	746.39	KL1B 19 + color* 150	746.39
160 - 62-15/16	KL1AR 19 + color* 160	794.66	KL1B 19 + color* 160	794.66
170 - 66-7/8	KL1AR 19 + color* 170	828.48	KL1B 19 + color* 170	828.48
180 - 70-13/16	KL1AR 19 + color* 180	875.95	KL1B 19 + color* 180	875.95

***Color Codes**



* To complete the item number, add the color code (e.g., KL1B 19 TSI 50).

NEW!

Now available in 7 TRENDLINE colors.

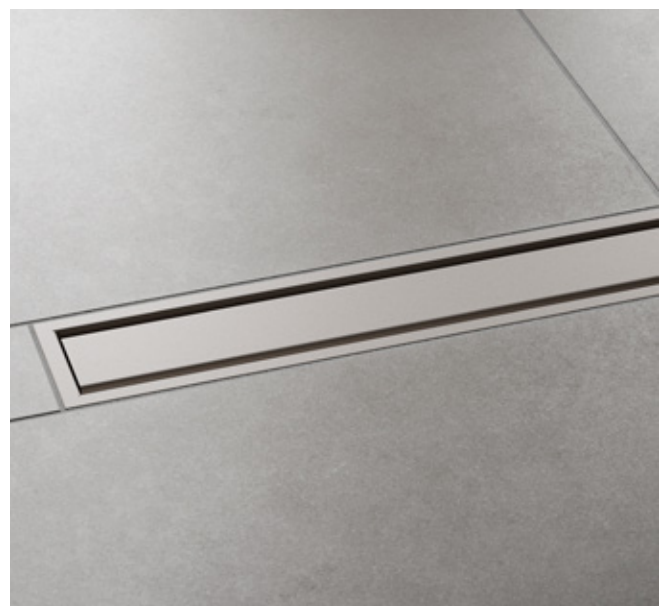
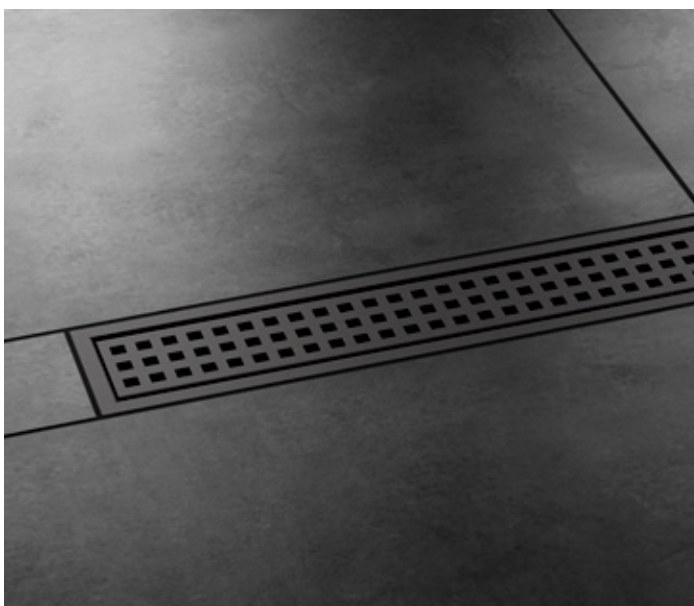



GRATE ASSEMBLY - TILE



TILE (D)

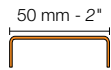

Grate assemblies - TILE			
Length = cm - in.	Item No.		\$ / Unit
	TILE (D)		
	For use with center outlet channel body	For use with off-set outlet channel body	
50 - 19-11/16	KL1DRE 50	-	158.22
60 - 23-5/8	KL1DRE 60	-	165.92
70 - 27-9/16	KL1DRE 70	KL1DRO E 70	173.59
80 - 31-1/2	KL1DRE 80	KL1DRO E 80	181.29
90 - 35-7/16	KL1DRE 90	KL1DRO E 90	194.38
100 - 39-3/8	KL1DRE 100	KL1DRO E 100	216.19
110 - 43-5/16	KL1DRE 110	KL1DRO E 110	223.82
120 - 47-1/4	KL1DRE 120	KL1DRO E 120	231.46
130 - 51-3/16	KL1DRE 130	-	279.10
140 - 55-1/8	KL1DRE 140	-	281.51
150 - 59-1/16	KL1DRE 150	-	284.39
160 - 62-15/16	KL1DRE 160	-	312.38
170 - 66-7/8	KL1DRE 170	-	315.46
180 - 70-13/16	KL1DRE 180	-	318.05

Schluter®-KERDI-LINE-STYLE

GRATE ASSEMBLY - BRUSHED STAINLESS STEEL STYLE DESIGNS



CURVE

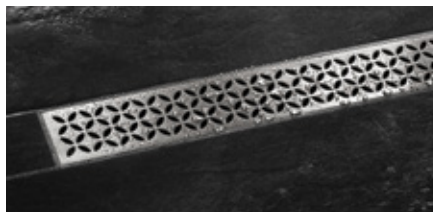
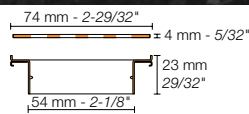

FLORAL

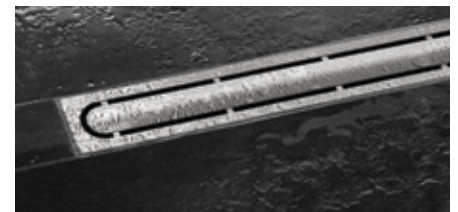
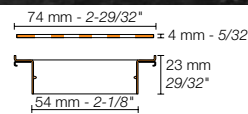

PURE

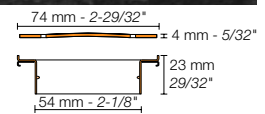

Grate assemblies - Brushed stainless steel



23 mm - 29/32" frame height for 6 - 18 mm - 1/4" - 11/16" -thick coverings

Length = cm - in.	CURVE		FLORAL		PURE	
	Item No.	\$ / Unit	Item No.	\$ / Unit	Item No.	\$ / Unit
50 - 19-11/16	KL1IFF 23 EB 50	354.02	KL1IFE 23 EB 50	367.90	KL1IFG 23 EB 50	395.67
60 - 23-5/8	KL1IFF 23 EB 60	367.90	KL1IFE 23 EB 60	381.80	KL1IFG 23 EB 60	409.55
70 - 27-9/16	KL1IFF 23 EB 70	381.80	KL1IFE 23 EB 70	395.67	KL1IFG 23 EB 70	426.91
80 - 31-1/2	KL1IFF 23 EB 80	402.62	KL1IFE 23 EB 80	423.44	KL1IFG 23 EB 80	444.25
90 - 35-7/16	KL1IFF 23 EB 90	423.44	KL1IFE 23 EB 90	451.19	KL1IFG 23 EB 90	465.09
100 - 39-3/8	KL1IFF 23 EB 100	444.25	KL1IFE 23 EB 100	478.97	KL1IFG 23 EB 100	485.92
110 - 43-5/16	KL1IFF 23 EB 110	465.09	KL1IFE 23 EB 110	506.74	KL1IFG 23 EB 110	513.67
120 - 47-1/4	KL1IFF 23 EB 120	485.92	KL1IFE 23 EB 120	534.49	KL1IFG 23 EB 120	541.43

Schluter®-KERDI-LINE

SQUARE GRATE WITH LOCKING MECHANISM

The Schluter®-KERDI-LINE SQUARE grate assembly (B) with 3/4" (19 mm) frame height is available with a locking mechanism for applications where tamper resistance is required.

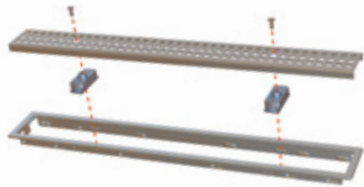

SQUARE grate assembly with locking mechanism		
Length = cm - in.	Item No.	\$ / Unit
50 - 19-11/16	KL1BL 19 EB 50	344.12
60 - 23-5/8	KL1BL 19 EB 60	348.62
70 - 27-9/16	KL1BL 19 EB 70	365.53
80 - 31-1/2	KL1BL 19 EB 80	370.57
90 - 35-7/16	KL1BL 19 EB 90	390.30
100 - 39-3/8	KL1BL 19 EB 100	398.04
110 - 43-5/16	KL1BL 19 EB 110	411.42
120 - 47-1/4	KL1BL 19 EB 120	416.80
130 - 51-3/16	KL1BL 19 EB 130	610.90
140 - 55-1/8	KL1BL 19 EB 140	639.31
150 - 59-1/16	KL1BL 19 EB 150	670.46
160 - 62-15/16	KL1BL 19 EB 160	710.96
170 - 66-7/8	KL1BL 19 EB 170	739.34
180 - 70-13/16	KL1BL 19 EB 180	779.15

Note: Driver bit for tamper-proof screws sold separately. Please see page 144.

LINEAR DRAIN ADAPTOR KIT — 5-1/2" (140 mm)

▲ Schluter®-KERDI-LINE-A

Schluter®-KERDI-LINE-A is an adaptor kit designed to convert a traditional clamping ring drain to a KERDI-LINE linear drain when removal of the clamping ring drain is not practical (e.g., when it is set in concrete slabs). The stainless steel adaptor ring features an over-molded rubber gasket and a variety of perforated hole patterns that align with most common clamping ring shower drains. The adaptor ring replaces the clamping ring and is attached to the drain body using the clamping ring bolts. This connection is made watertight via the rubber gasket and KERDI-FIX adhesive/sealant. The KERDI-LINE channel body outlet slides into the adaptor ring, with a tight fit to the over-molded rubber gasket, ensuring a watertight seal. The KERDI-LINE-A adaptor kit is suitable for both mortar bed and KERDI-SHOWER-LT/-LTS shower tray applications.



Schluter®-KERDI-LINE-A			
Linear drain adaptor kit (140 mm - 5-1/2")			
1 UNIT		10-PACK*	
Item No.	\$ / Unit	Item No.	\$ / 10-Pack
KLAM 5K	45.90	KLAM 5K 10	413.10

*Note: 10-packs are packaged in bulk, not individually boxed.



Additional component included	
	<p>1x KERDI-FIX sealing and bonding compound (100 ml - 3.38 fl oz)</p> <p>WARNING: Reproductive Harm www.P65Warnings.ca.gov</p>

Adaptor ring measurements	
	<p>A 139.7 mm - 5-1/2"</p> <p>B 64.6 mm - 2-9/16"</p>



COVER PLATE

Schluter®-KERDI-LINE-FC

Schluter®-KERDI-LINE-FC is a stainless steel cover plate for use with the Schluter®-KERDI-LINE linear floor drain to create a seamless look in applications where multiple drains are installed end to end. KERDI-LINE-FC is designed for use with either the SOLID or SQUARE grates.

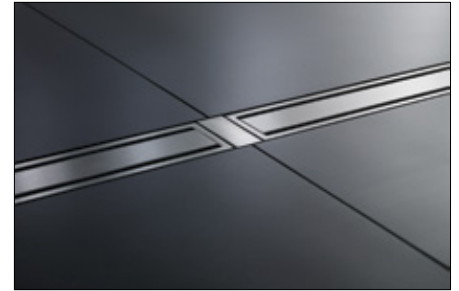
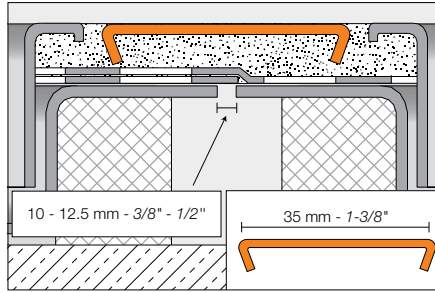

Schluter®-KERDI-LINE-FC			
Brushed stainless steel		Chrome	
Item No.	\$ / Unit	Item No.	\$ / Unit
V / KLEB 35	18.40	V / KLEP 35	18.40

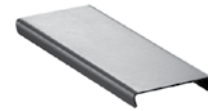

▲ Matte White and Matte Black

Matte color-coated	
Item No.	\$ / Unit
V / KL + color* 35	21.30

***Color Codes**

MBW
Matte white

MGS
Matte black

* To complete the item number, add the color code (e.g., V / KL **MGS** 35).

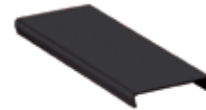

▲ Schluter®-TRENDLINE Textured Color-coated

Textured color-coated	
Item No.	\$ / Unit
V / KL + color* 35	21.94

***Color Codes**

TSI
Ivory

TSBG
Greige

TSSG
Stone grey

TSC
Cream

TSOB
Bronze

TSG
Pewter

TSDA
Dark anthracite

* To complete the item number, add the color code (e.g., V / KL **TSI** 35).

STRAINER

The **Schluter®-KERDI-LINE Strainer** is a hair catcher customized to fit inside the KERDI-LINE channel body to trap and collect hair. Simple to remove and clean, the hair catcher fits discreetly into the drain to prevent hair clogs that can lead to blocked pipes.



Strainer for KERDI-LINE		
Item No.	Description	\$ / Unit
KL VZ SF	Strainer	3.36



Schluter®-KERDI-LINE-VARIO

Variable length linear drain

The next generation of linear drains is here: KERDI-LINE-VARIO is a variable length linear drain for tiled showers. The stainless steel channel and grate assembly can be cut to size on-site, and are therefore customizable to fit various shower sizes.

NEW! Now available in TRENDLINE textured color-coated finishes. See page 156.

Schluter®-KERDI-LINE-VARIO

Schluter®-KERDI-LINE-VARIO is a low-profile, variable length linear shower drain specifically designed for bonded waterproofing assemblies. KERDI-LINE-VARIO can be initially cut to size on-site to fit the specific dimensions of the shower. The floor can be sloped on a single plane to KERDI-LINE-VARIO, which enables the use of large-format tiles and creates interesting design opportunities.

The KERDI-LINE-VARIO flange comprises an injection molded polypropylene drain body featuring a standard 2" (50 mm) NPT outlet and is supplied with PVC and ABS couplings. The perimeter consists of a bonding flange laminated with a collar made of KERDI for a simple and secure connection to the bonded waterproofing assembly, both in the floor area and on adjacent walls. KERDI-LINE-VARIO can be installed in conjunction with the KERDI-SHOWER-LT-/LTS shower trays or with a mortar bed.

The KERDI-LINE-VARIO channel and grate assembly is made of formed stainless steel 316L (1.4404 = V4A) and is designed to be trimmed to length to ensure a proper fit in custom applications. The channel features a drainage opening in the center. The flange outlet may be positioned anywhere within the overall trimmed length of the channel to avoid obstacles encountered during construction (e.g., floor joists). The grate nests into the corresponding channel. If the grate is trimmed, the supplied end caps are used to provide a clean finished look.

The KERDI-LINE-VARIO grate assembly features a minimal reveal after installation and is available in brushed stainless steel or TRENDLINE textured color-coated finishes in four designs:

- SQUARE
- FLORAL
- HERRINGBONE
- SLANT

The KERDI-LINE-VARIO flange kit and the grate and channel kit must be purchased separately.

Notes:

- The shortest allowable length to cut the channel and grate is 10" (25.4 cm).
- The minimum recommended tile thickness to use with the KERDI-LINE-VARIO channel is 3/8" (10 mm).
- KERDI-LINE-VARIO is best suited for placement against the wall but can also be installed in the center of the shower. For drain placement at the entrance of the shower, please refer to the KERDI-LINE linear drain.
- KERDI-LINE-VARIO drains are designed to meet the International Plumbing Code (IPC) guideline for a single standard showerhead with a maximum flow of 2.5 gpm (9.5 L/m). For showers with higher flow, the KERDI-LINE linear drain is recommended.

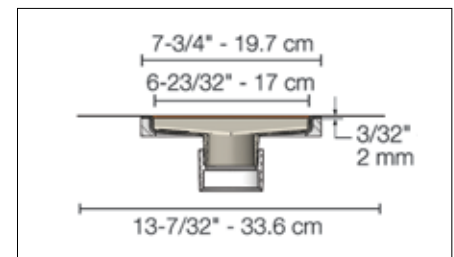
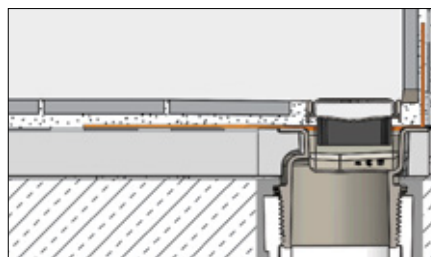

All configurations of KERDI-LINE-VARIO are listed by ICC-ES (Report No. PMG-1204) and UPC®. For copies of these documents, please contact Schluter®-Systems at 800-472-4588 or by email at info@schluter.com. Links to the documents can also be accessed at Schluter.com.



Schluter®-KERDI-LINE-VARIO

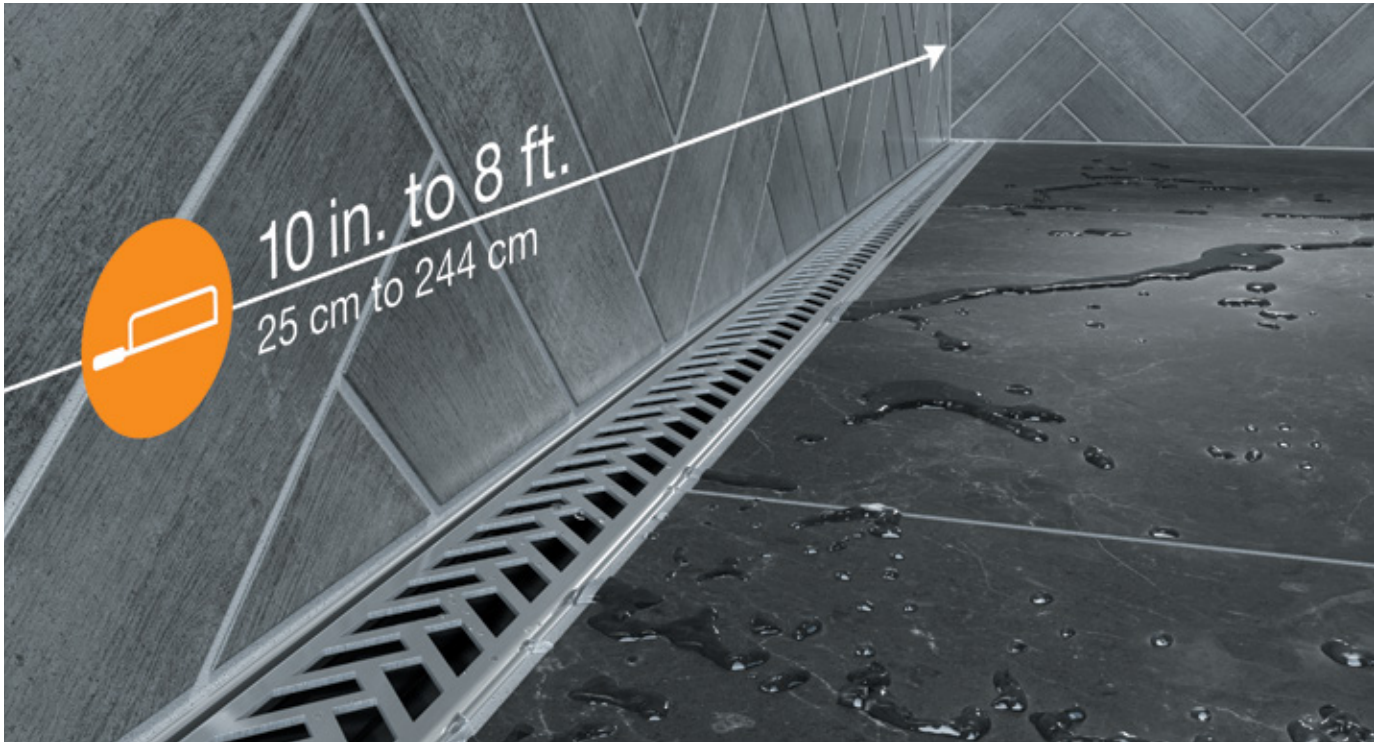

FLANGE KIT

Contents



1x
Flange



4x
Inside corners



2x
Outside corners



1x
Downspout



1x
Pipe seal
(20 mm - 3/4")



1x
Mixing valve seal
(114 mm - 4-1/2")



1x
Flange support



1x
Cleaning brush



1x
Grate removal tool



1x ABS coupling
1x PVC coupling



1x
Construction cover

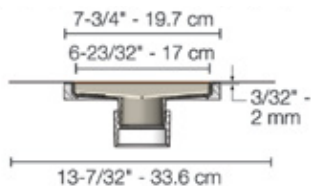

KERDI-LINE-VARIO			
Flange Kit			
Material	Outlet	Item No.	\$ / Unit
Polypropylene	50 mm - 2" NPT	KL VR 2 FLK	125.46

GRATE AND CHANNEL KIT

Contents

1x Grate
 4 options:
 • HERRINGBONE
 • SLANT
 • FLORAL
 • SQUARE

2x End caps

1x Channel



HERRINGBONE



SLANT



FLORAL



SQUARE

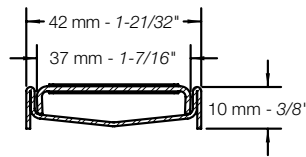

Brushed stainless steel

Grate and Channel Kit – Brushed stainless steel						
Length = cm - in.	HERRINGBONE	SLANT	FLORAL	\$ / Unit	SQUARE	\$ / Unit
	Item No.	Item No.	Item No.		Item No.	
122 - 48	KL VRI D13 EB 122	KL VRI D14 EB 122	KL VRI D5 EB 122	254.69	KL VRI D3 EB 122	267.24
244 - 96	KL VRI D13 EB 244	KL VRI D14 EB 244	KL VRI D5 EB 244	479.48	KL VRI D3 EB 244	488.59

Schluter®-TRENDLINE textured color-coated stainless steel

Grate and Channel Kit – Textured color-coated stainless steel						
Length = cm - in.	HERRINGBONE	SLANT	FLORAL	SQUARE	\$ / Unit	
	Item No.	Item No.	Item No.	Item No.		
122 - 48	KL VRI D13 + color* 122	KL VRI D14 + color* 122	KL VRI D5 + color* 122	KL VRI D3 + color* 122	336.60	
244 - 96	KL VRI D13 + color* 244	KL VRI D14 + color* 244	KL VRI D5 + color* 244	KL VRI D3 + color* 244	591.60	

***Color Codes**

Ivory	Greige	Stone grey	Cream	Bronze	Pewter	Dark anthracite	Matte white	Matte black

* To complete the item number, add the color code (e.g., KL VRI D3 **TSI** 122).

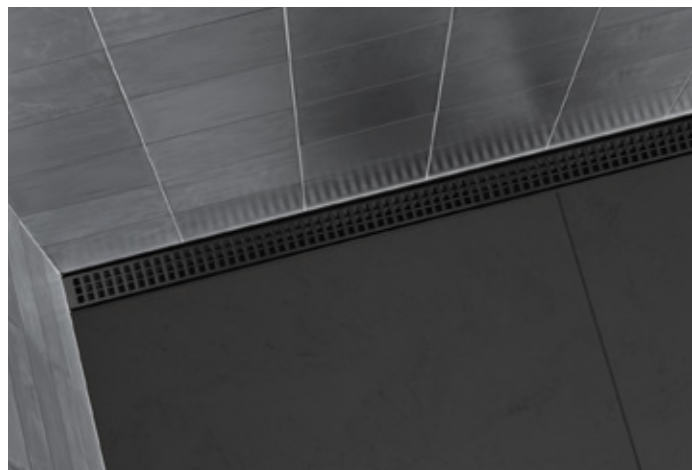



Prefabricated Substrates

Prefabricated shower trays, curbs, ramps, benches, and niches integrate seamlessly with KERDI and KERDI-BOARD shower assemblies, and are ideal solutions for including mortar-free shower components in any tiled shower. Quick and easy to install, Schluter prefabricated substrates combine comfort, convenience, and design and are available in multiple sizes and shapes to fit any décor.

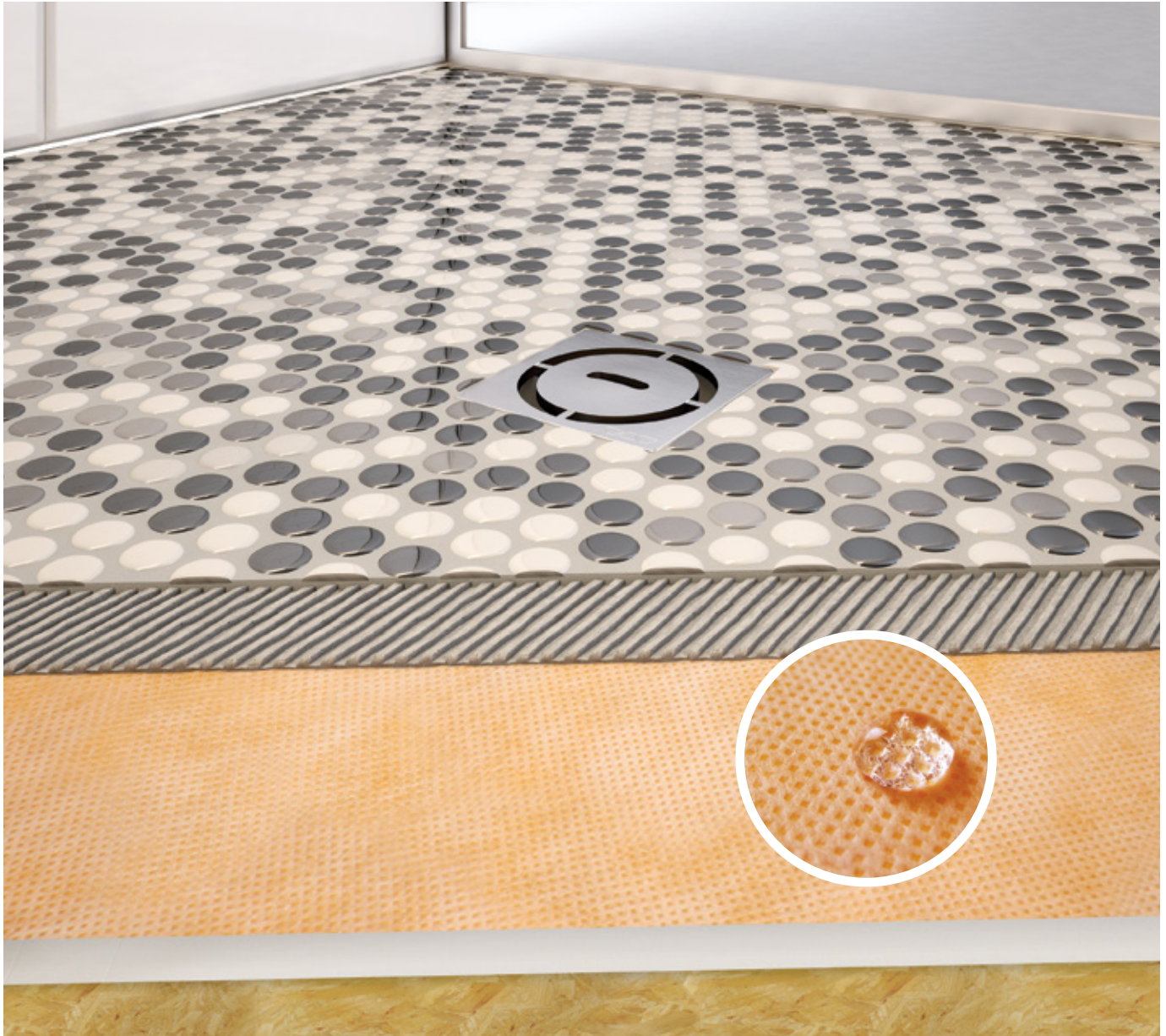



Schluter®-KERDI-SHOWER-T/-TS/-TT

Schluter®-KERDI-SHOWER-T/-TS/-TT are sloped shower trays with integrated KERDI waterproofing. The trays are made of lightweight, expanded polystyrene (PS 40) for constructing mortar-free shower bases. Each of these prefabricated shower trays is designed to integrate with the Schluter®-KERDI-DRAIN.

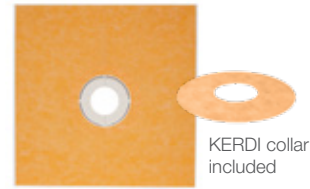

The **KERDI-SHOWER-T** is the standard tray with center drain placement.

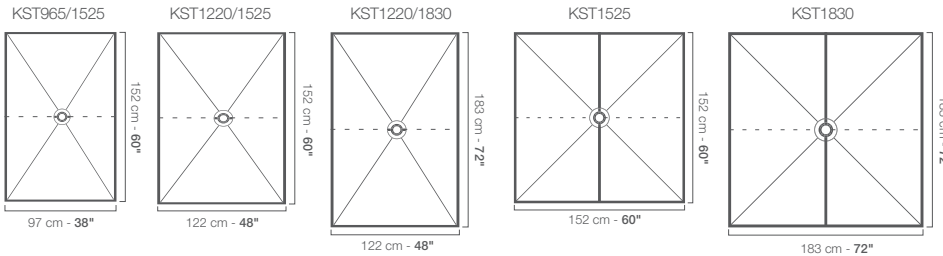

Schluter®-KERDI-SHOWER-T				
Tray with center drain placement				
Item No.	Dimensions	Perimeter height	Drain placement	\$ / Unit
KST 965/1525	97 cm x 152 cm - 38" x 60"	29 mm - 1-1/8"	center	147.76
KST 1220/1525	122 cm x 152 cm - 48" x 60"	28 mm - 1-3/32"	center	220.05
KST 1220/1830	122 cm x 183 cm - 48" x 72"	32 mm - 1-1/4"	center	235.78
KST 1525	152 cm x 152 cm - 60" x 60"	30 mm - 1-3/16"	center	289.22
KST 1830	183 cm x 183 cm - 72" x 72"	32 mm - 1-1/4"	center	314.36

The **KERDI-SHOWER-TS** is the standard tray with off-center drain placement.

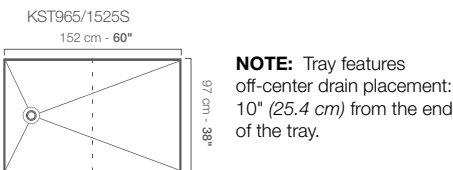

Schluter®-KERDI-SHOWER-TS				
Tray with off-center drain placement				
Item No.	Dimensions	Perimeter height	Drain placement	\$ / Unit
KST 965/1525 S	97 cm x 152 cm - 38" x 60"	29 mm - 1-1/8"	off-center	147.76

The **KERDI-SHOWER-TT** features a thin perimeter height that simplifies the construction of curbless showers.

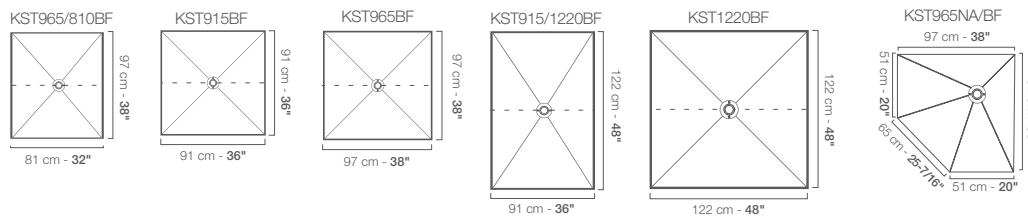

NEO ANGLE TRAY:

- Features off-center drain placement: 12" (30.5 cm) from the 38" (97 cm) sides of the tray.
- Includes two 135° inside waterproofing corners.



Schluter®-KERDI-SHOWER-TT				
Thin tray				
Item No.	Dimensions	Perimeter height	Drain placement	\$ / Unit
KST 965/810 BF	81 cm x 97 cm - 32" x 38"	23 mm - 29/32"	center	144.62
KST 915 BF	91 cm x 91 cm - 36" x 36"	22 mm - 7/8"	center	110.03
KST 965 BF	97 cm x 97 cm - 38" x 38"	23 mm - 29/32"	center	122.59
KST 915/1220 BF	91 cm x 122 cm - 36" x 48"	25 mm - 1"	center	169.76
KST 1220 BF	122 cm x 122 cm - 48" x 48"	25 mm - 1"	center	135.18
KST 965NA/ BF	97 cm x 97 cm - 38" x 38" Neo angle	26 mm - 1-1/32"	off-center	150.90



Schluter®-KERDI-SHOWER-LT/-LTS

Schluter®-KERDI-SHOWER-LT/-LTS are polystyrene sloped trays with integrated Schluter®-KERDI waterproofing. Each of these prefabricated shower trays is designed to integrate with the Schluter®-KERDI-LINE.



The **KERDI-SHOWER-LT** allows for the installation of a center drain.

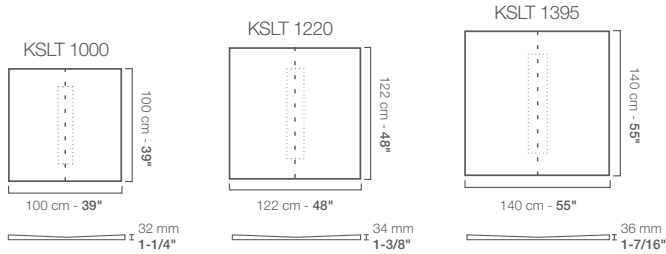

Schluter®-KERDI-SHOWER-LT				
Tray with center linear drain placement				
Item No.	Dimensions	Height at ends	Drain placement	\$ / Unit
KSLT 1000	100 cm x 100 cm - 39" x 39"	32 mm - 1-1/4"	center	222.06
KSLT 1220	122 cm x 122 cm - 48" x 48"	34 mm - 1-3/8"	center	296.14
KSLT 1395	140 cm x 140 cm - 55" x 55"	36 mm - 1-7/16"	center	373.14

The **KERDI-SHOWER-LTS** accommodates the installation of the drain along the perimeter of the shower.

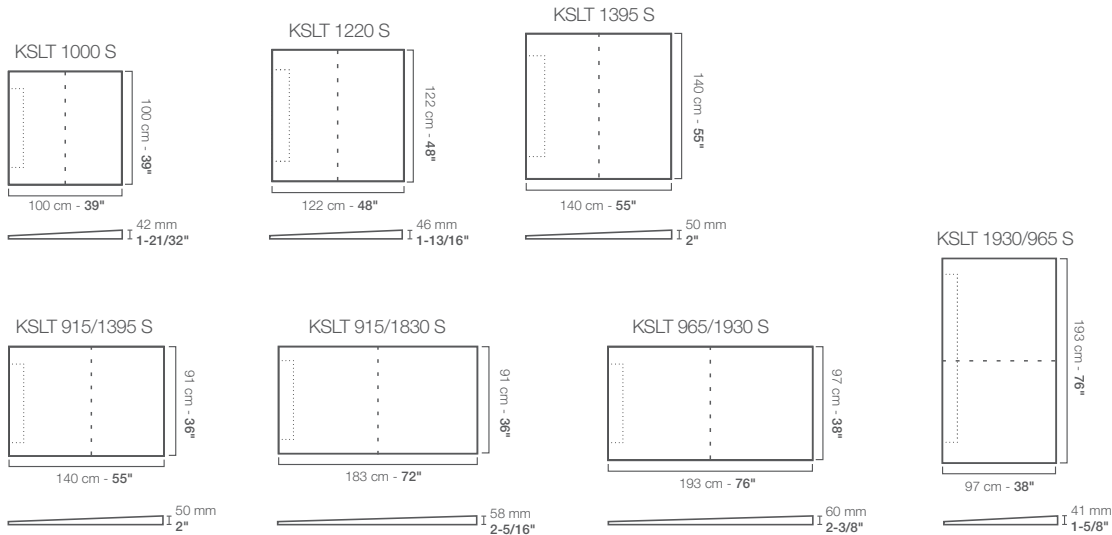

Schluter®-KERDI-SHOWER-LTS				
Tray with perimeter linear drain placement				
Item No.	Dimensions	Height at end	Drain placement	\$ / Unit
KSLT 1000 S	100 cm x 100 cm - 39" x 39"	42 mm - 1-21/32"	perimeter	222.06
KSLT 1220 S	122 cm x 122 cm - 48" x 48"	46 mm - 1-13/16"	perimeter	296.14
KSLT 1395 S	140 cm x 140 cm - 55" x 55"	50 mm - 2"	perimeter	373.14
KSLT 915/1395 S	91 cm x 140 cm - 36" x 55"	50 mm - 2"	perimeter	260.59
KSLT 915/1830 S	91 cm x 183 cm - 36" x 72"	58 mm - 2-5/16"	perimeter	349.44
KSLT 965/1930 S	97 cm x 193 cm - 38" x 76"	60 mm - 2-3/8"	perimeter	384.98
KSLT 1930/965 S	193 cm x 97 cm - 76" x 38"	41 mm - 1-5/8"	perimeter	384.98

Schluter®-KERDI-SHOWER-CB

Schluter®-KERDI-SHOWER-CB is a height compensation board made of lightweight expanded polystyrene. Two versions are available:

- The 1" (2.5 cm)-thick compensation board is used to accommodate the adaptor ring height when installing the KERDI-DRAIN-A adaptor in conjunction with the KERDI-SHOWER-T/TS/TT shower trays.

- The 3-1/2" (8.9 cm)-thick compensation board is used to accommodate the drain body and waste pipe height, when installing the KERDI-DRAIN-H in conjunction with the KERDI-SHOWER-T/TS/TT shower trays.

The compensation board can easily be cut to size to fit around the drain and waste pipe in KERDI-DRAIN-H applications or the adaptor ring in KERDI-DRAIN-A applications. Multiple boards can be used to fit the size and shape of the shower.

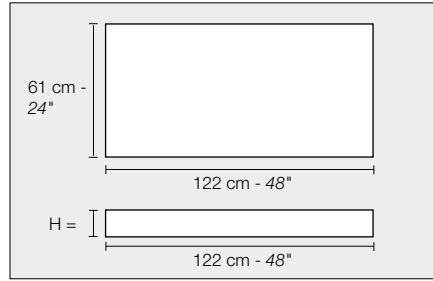

Schluter®-KERDI-SHOWER-CB				
Compensation board				
H = cm - in.	Item No.	Dimensions	\$ / Unit	Units / Bundle
▲ 2.5 - 1	KSCB 25 610 1220	122 cm x 61 cm - 48" x 24"	27.20	6*
8.9 - 3-1/2	KSCB 90 610 1220	122 cm x 61 cm - 48" x 24"	109.30	1

*The 1" (2.5 cm)-thick compensation board (KSCB 25 610 1220) is sold in bundles of 6 units. Please order in multiples of the bundle quantity.

Schluter®-KERDI-SHOWER-R

Schluter®-KERDI-SHOWER-R is a lightweight, expanded polystyrene shower ramp with integrated Schluter®-KERDI waterproofing designed to facilitate the construction of access ramps for tiled showers. The ramp integrates with the Schluter®-Shower System to create accessible, curbless showers and adheres to the ADA's slope ratio.

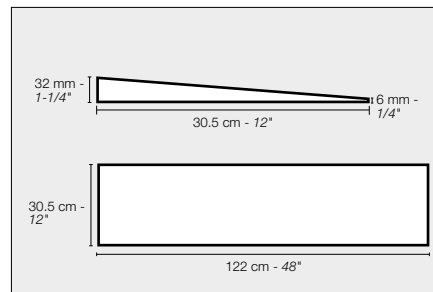

Schluter®-KERDI-SHOWER-R			
Ramp			
Item No.	Length	Width	\$ / Unit
KSR 305/1220	122 cm - 48"	30.5 cm - 12"	112.97

Schluter®-KERDI-BOARD-SC

Schluter®-KERDI-BOARD-SC is a prefabricated shower curb made of KERDI-BOARD that is designed to integrate with the Schluter®-Shower System. The curb is lightweight, stable, and load bearing. It can be used in conjunction with the KERDI-SHOWER prefabricated shower trays as well as in mortar bed applications. KERDI-BOARD-SC is quick and easy to install, waterproof and ready to tile, making it a simple solution for tiled shower curbs.

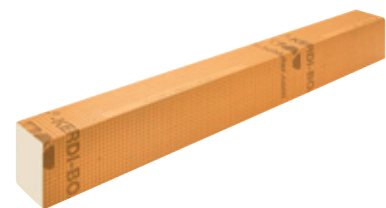
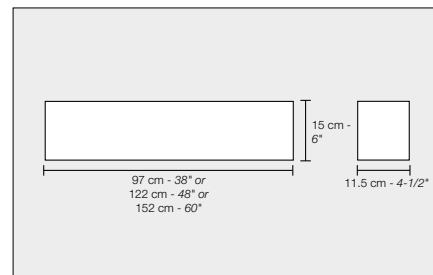

Schluter®-KERDI-BOARD-SC				
Curb				
Item No.	Length	Width	Height	\$ / Unit
KBSC 115 150 970	97 cm - 38"	11.5 cm - 4-1/2"	15 cm - 6"	67.17
KBSC 115 150 1220	122 cm - 48"	11.5 cm - 4-1/2"	15 cm - 6"	73.27
KBSC 115 150 1524	152 cm - 60"	11.5 cm - 4-1/2"	15 cm - 6"	107.46

⚠ **WARNING:** Cancer and Reproductive Harm - www.P65Warnings.ca.gov



Schluter®-KERDI-BOARD-SB

Schluter®-KERDI-BOARD-SB is a prefabricated shower bench made of KERDI-BOARD that is designed to integrate with the Schluter®-Shower System. The bench is lightweight, stable, and load bearing. It features a sloped surface to prevent the accumulation of water. KERDI-BOARD-SB is quick and easy to install, waterproof and ready to tile, making it a simple solution for tiled shower benches.

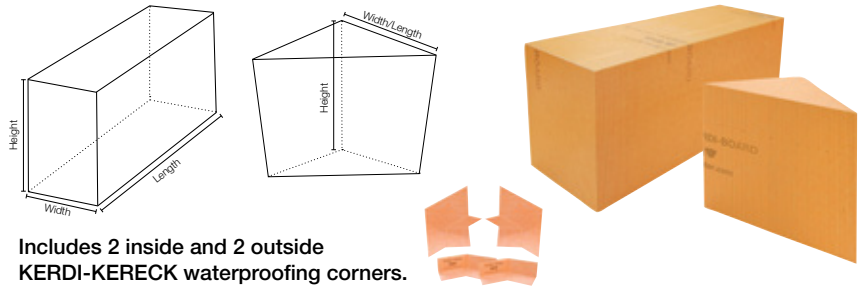

Includes 2 inside and 2 outside KERDI-KERECK waterproofing corners.





Schluter®-KERDI-BOARD-SB					
Bench					
Item No.	Length	Width	Height	Shape	\$ / Unit
KBSB 410 TA	41 cm - 16"	41 cm - 16"	51 cm - 20"	Triangular	185.61
KBSB 610 TA	61 cm - 24"	61 cm - 24"	51 cm - 20"	Triangular	241.79
KBSB 290 970 RA	97 cm - 38"	29 cm - 11-1/2"	51 cm - 20"	Rectangular	299.19
KBSB 410 1220 RA	122 cm - 48"	41 cm - 16"	51 cm - 20"	Rectangular	396.88

⚠ WARNING: Cancer and Reproductive Harm - www.P65Warnings.ca.gov

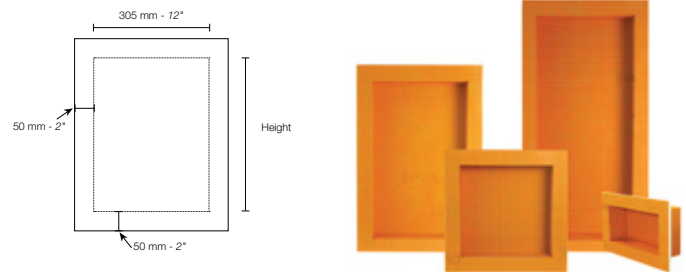
Schluter®-KERDI-BOARD-SN

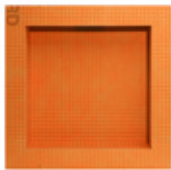
Schluter®-KERDI-BOARD-SN is a prefabricated shower niche made of Schluter®-KERDI-BOARD that can be installed in both Schluter®-KERDI and KERDI-BOARD wall assemblies. The shower niche features a 1/2" (12.5 mm) -thick by 2" (50 mm) -wide integrated bonding flange and is available in 4 different sizes.



Contents		
		
1x Niche	1x KERDI-BAND waterproofing frame	
		8x KERDI-BOARD-ZS Screws
		8x KERDI-BOARD-ZT Washers

Schluter®-KERDI-BOARD-SN				
Niche				
Item No.	Height	Width	Depth	\$ / Unit
KB 12 SN 305 152 AF	152 mm - 6"	305 mm - 12"	89 mm - 3-1/2"	66.57
KB 12 SN 305 305 AF	305 mm - 12"	305 mm - 12"	89 mm - 3-1/2"	79.72
KB 12 SN 305 508 AF	508 mm - 20"	305 mm - 12"	89 mm - 3-1/2"	107.76
KB 12 SN 305 711 AF	711 mm - 28"	305 mm - 12"	89 mm - 3-1/2"	128.80

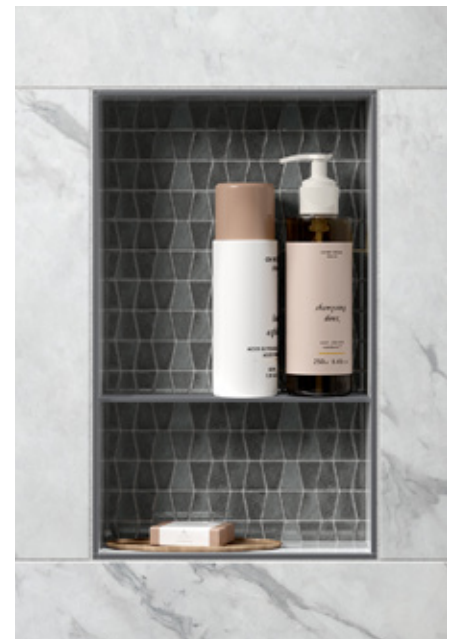

⚠ WARNING: Cancer and Reproductive Harm - www.P65Warnings.ca.gov



KERDI-BOARD-SNLT
Horizontal niches with
integrated LIPROTEC LED lighting
(page 164)

NEW in Niches!



DESIGN-NICHE
Aluminum niche kits
(pages 166-167)



Schluter®-KERDI-BOARD-SNLT

Schluter®-KERDI-BOARD-SNLT is a prefabricated shower niche made of KERDI-BOARD that incorporates a mounting profile with a diffused Schluter®-LIPROTEC LED light strip. A pre-installed, waterproof connection box at the top of the niche ensures that the electrical connection is code compliant. KERDI-BOARD-SNLT features a 1/2" (12.5 mm) -thick by 2" (50 mm) -wide integrated bonding flange and is available in 3 sizes designed for a vertical installation and 2 sizes designed for a horizontal installation.







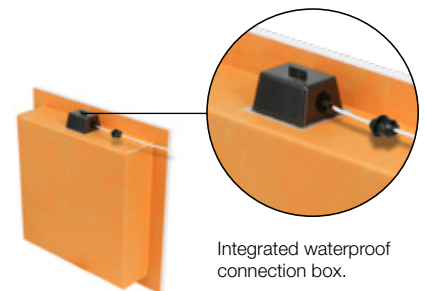
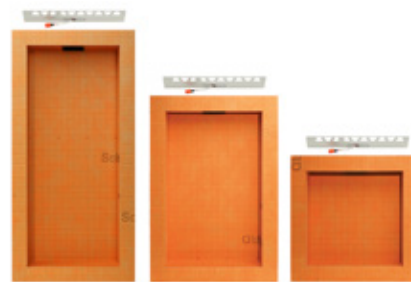
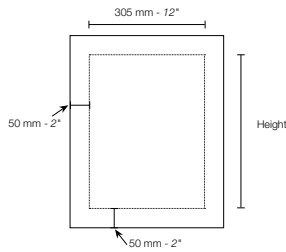

The mounting profile is made of anodized aluminum with satin finish (AE) and is sized to fit along the top of the niche. The LED light strip is encased in a silicone tube that nests into the mounting profile and provides an evenly diffused line of light.

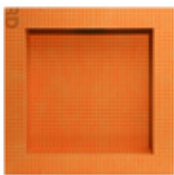

Vertical Installation



Integrated waterproof connection box.

Contents			
	1x Niche		1x Mounting profile
	1x KERDI-BAND waterproofing frame		1x LED strip (warm white)
	1x Stainless steel connection box with cover		8x KERDI-BOARD-ZS Screws
	1x Self-adhesive patch		8x KERDI-BOARD-ZT Washers

Schluter®-KERDI-BOARD-SNLT					
Niche with LIPROTEC LED lighting – vertical installation					
Item No.	Height	Width	Depth	LED color	\$ / Unit
KB 12 SNLT 1 WW F	305 mm - 12"	305 mm - 12"	89 mm - 3-1/2"	Warm white	309.04
KB 12 SNLT 2 WW F	508 mm - 20"	305 mm - 12"	89 mm - 3-1/2"	Warm white	326.98
KB 12 SNLT 3 WW F	711 mm - 28"	305 mm - 12"	89 mm - 3-1/2"	Warm white	356.70

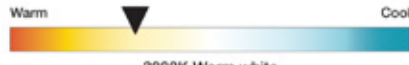
Lighting Facts	
Brightness	118 lumens
Energy used	1.7 watts
Color accuracy (Color rendering index - CRI)	90+
Light appearance	
	

WARNING: Cancer and Reproductive Harm - www.P65Warnings.ca.gov



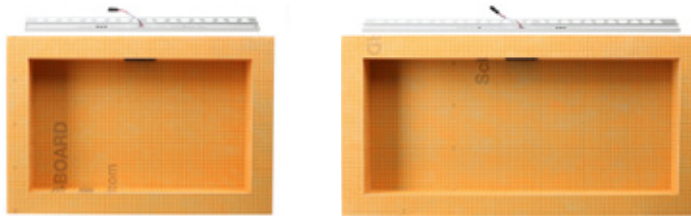
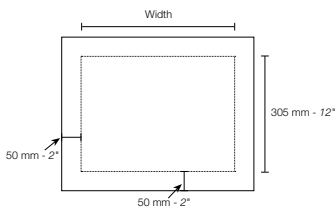

▲ Horizontal Installation





Contents

- 

1x
Niche
- 

1x
Mounting profile
- 

8x
KERDI-BOARD-ZS
Screws
- 

1x
LED strip (warm white)
- 

8x
KERDI-BOARD-ZT
Washers
- 

1x
KERDI-BAND
waterproofing frame
- 

1x
Stainless steel
connection box
with cover
- 

1x
Self-adhesive
patch

▲ Schluter®-KERDI-BOARD-SNLT					
Niche with LIPROTEC LED lighting – horizontal installation					
Item No.	Height	Width	Depth	LED color	\$ / Unit
KB 12 SNLT 4 WW F	305 mm - 12"	508 mm - 20"	89 mm - 3-1/2"	Warm white	350.50
KB 12 SNLT 5 WW F	305 mm - 12"	711 mm - 28"	89 mm - 3-1/2"	Warm white	438.50

⚠ WARNING: Cancer and Reproductive Harm - www.P65Warnings.ca.gov

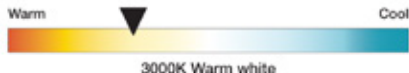
Lighting Facts		
	12x20	12x28
Brightness	230 lumens	303 lumens
Energy used	3.0 watts	4.0 watts
Color accuracy (Color rendering index - CRI)	90+	
Light appearance	 <p>3000K Warm white</p>	



Schluter®-LIPROTEC-ECX

Schluter®-LIPROTEC-ECX is an all-in-one LED power supply and in-wall dimmer switch that eliminates compatibility issues between drivers and dimmer switches. LIPROTEC-ECX is designed for use with the KERDI-BOARD-SNLT niche with white LED strip. Three interchangeable face plates (white, light almond, and dark brown) are included to match most decors.

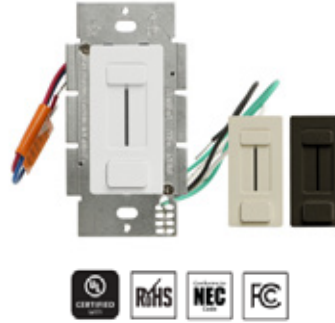

Note: the trim plate must be purchased separately.

- Dimming range: 5% to 100%
- Can control multiple KERDI-BOARD-SNLT niches (up to 60 watts)
- Fits in a standard electrical box
- UL listed in USA and Canada

Schluter®-LIPROTEC-ECX				
LED driver and dimmer				
Item No.	Input	Output	Power	\$ / Unit
LT ECX 1W	120V AC	24V DC	60 W	264.45

⚠ WARNING: Cancer and Reproductive Harm - www.P65Warnings.ca.gov

Schluter®-LIPROTEC-ECD

Schluter®-LIPROTEC-ECD is an in-line dimmable driver that is hard wired into your electrical, designed for use with the KERDI-BOARD-SNLT niche with white LED strip. It is compatible with a range of popular dimmer switches, allowing you to have matching light switches throughout your bathroom. LIPROTEC-ECD includes a metal enclosure and must be installed in an accessible location, such as a closet or vanity.



Note: a compatible dimmer switch must be purchased separately, refer to the compatibility list on www.schluter.com

- Dimming range: 5% to 100%
- Can control multiple KERDI-BOARD-SNLT niches (up to 24 watts)
- UL listed in USA and Canada

Schluter®-LIPROTEC-ECD				
Dimmable LED driver				
Item No.	Input	Output	Power	\$ / Unit
LT ECD 1W	120V AC	24V DC	24 W	160.93

⚠ WARNING: Cancer and Reproductive Harm - www.P65Warnings.ca.gov

Schluter®-LIPROTEC-CW

Schluter®-LIPROTEC-CW cables are designed to connect the KERDI-BOARD-SNLT niche to the LIPROTEC-ECX or ECD power supply. The cables feature a pre-installed waterproof snap-in gland for a secure connection to the top of the niche, and connectors to attach the LED strip. LIPROTEC-CW is rated for in-wall installation (no conduit required).



- Class 2 low voltage cable (CL2)
- CSA FT4 rated (80°C)
- UL listed in USA and Canada

Schluter®-LIPROTEC-CW				
Cable for LIPROTEC white LED system				
Item No.	Length	Gauge	Conductors	\$ / Unit
LT CW / 4M	4 m – 13' 1-1/2"	20AWG	2	48.69
LT CW / 8M	8 m – 26' 3"	20AWG	2	78.93
LT CW / 15M	15 m – 49' 2-1/2"	20AWG	2	137.35

⚠ WARNING: Cancer and Reproductive Harm - www.P65Warnings.ca.gov

NEW! Schluter®-DESIGN-NICHE

Schluter®-DESIGN-NICHE is a prefabricated niche made of powder-coated aluminum to create storage space for any wall area. Its adjustable frame fits any tile thickness for a flush installation or can be installed with a reveal edge for a stylish design. It is available in three different sizes, five TRENDLINE colors, and has the versatility to be installed horizontally or vertically. DESIGN-NICHE includes an adjustable anodized aluminum frame, precut KERDI-BAND frame and KERDI-FIX single-component sealing and bonding compound for waterproof applications.





Schluter®-DESIGN-NICHE

Contents

- 1x** Aluminum shower niche
- 1x** Adjustable frame
- 1x** KERDI-BAND waterproofing frame
- 4x** Adjustable nuts (Largest size includes 8 adjustable nuts)
- 4x** Foam spacers
- 1x** KERDI-FIX sealing and bonding compound (290 ml - 9.81 fl oz)

WARNING:
 Reproductive Harm www.P65Warnings.ca.gov

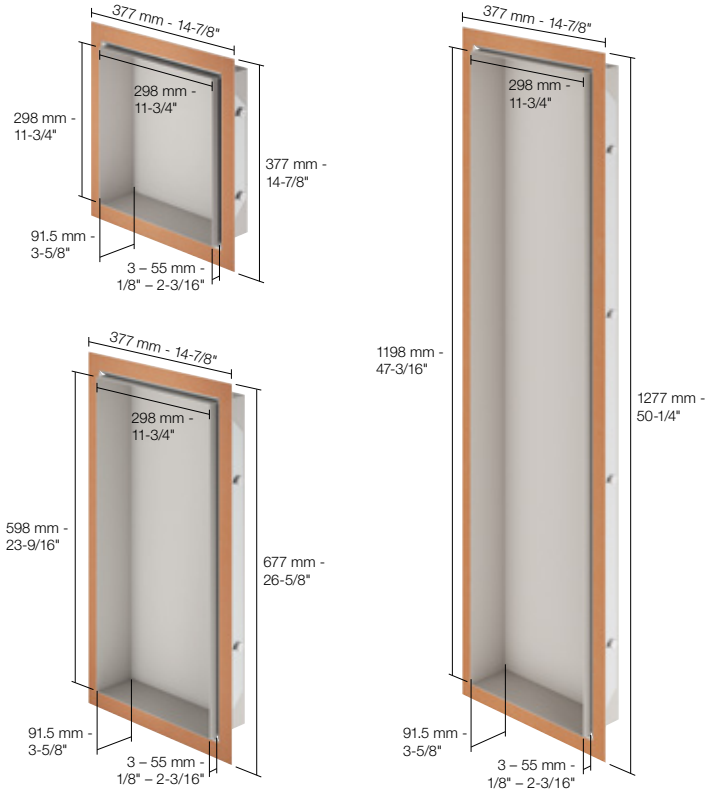

Schluter®-DESIGN-NICHE

Color-coated aluminum niche kit - 300 mm x 300 mm - 12" x 12" (nom.)

Item No.	Color	Height 1	Height 2	Depth	\$/ Unit
DNA1 MBW	Matte White (MBW)	298 mm - 11-3/4"	298 mm - 11-3/4"	91.5 mm - 3-5/8"	340.00
DNA1 MGS	Matte Black (MGS)	298 mm - 11-3/4"	298 mm - 11-3/4"	91.5 mm - 3-5/8"	340.00
DNA1 TSI	Ivory (TSI)	298 mm - 11-3/4"	298 mm - 11-3/4"	91.5 mm - 3-5/8"	350.00
DNA1 TSBG	Greige (TSBG)	298 mm - 11-3/4"	298 mm - 11-3/4"	91.5 mm - 3-5/8"	350.00
DNA1 TSDA	Dark Anthracite (TSDA)	298 mm - 11-3/4"	298 mm - 11-3/4"	91.5 mm - 3-5/8"	350.00

Color-coated aluminum niche kit - 300 mm x 600 mm - 12" x 24" (nom.)

Item No.	Color	Height 1	Height 2	Depth	\$/ Unit
DNA2 MBW	Matte White (MBW)	298 mm - 11-3/4"	598 mm - 23-9/16"	91.5 mm - 3-5/8"	460.00
DNA2 MGS	Matte Black (MGS)	298 mm - 11-3/4"	598 mm - 23-9/16"	91.5 mm - 3-5/8"	460.00
DNA2 TSI	Ivory (TSI)	298 mm - 11-3/4"	598 mm - 23-9/16"	91.5 mm - 3-5/8"	470.00
DNA2 TSBG	Greige (TSBG)	298 mm - 11-3/4"	598 mm - 23-9/16"	91.5 mm - 3-5/8"	470.00
DNA2 TSDA	Dark Anthracite (TSDA)	298 mm - 11-3/4"	598 mm - 23-9/16"	91.5 mm - 3-5/8"	470.00

Color-coated aluminum niche kit - 300 mm x 1200 mm - 12" x 48" (nom.)

Item No.	Color	Height 1	Height 2	Depth	\$/ Unit
DNA3 MBW	Matte White (MBW)	298 mm - 11-3/4"	1198 mm - 47-3/16"	91.5 mm - 3-5/8"	600.00
DNA3 MGS	Matte Black (MGS)	298 mm - 11-3/4"	1198 mm - 47-3/16"	91.5 mm - 3-5/8"	600.00
DNA3 TSI	Ivory (TSI)	298 mm - 11-3/4"	1198 mm - 47-3/16"	91.5 mm - 3-5/8"	610.00
DNA3 TSBG	Greige (TSBG)	298 mm - 11-3/4"	1198 mm - 47-3/16"	91.5 mm - 3-5/8"	610.00
DNA3 TSDA	Dark Anthracite (TSDA)	298 mm - 11-3/4"	1198 mm - 47-3/16"	91.5 mm - 3-5/8"	610.00

Color-coated aluminum





Shower & Tub Kits

Our kits are convenient solutions to providing all the components required to build waterproof showers and bathtub surrounds. With various sizes, options, and configurations, there's a perfect kit for virtually every bathroom project.



Schluter®-KERDI-SHOWER-KIT

The **Schluter®-KERDI-SHOWER-KIT** is an all-inclusive package containing each of the integrated family of components required to create a maintenance-free, watertight shower assembly without a mortar bed.

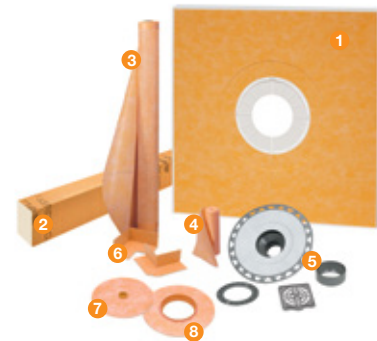
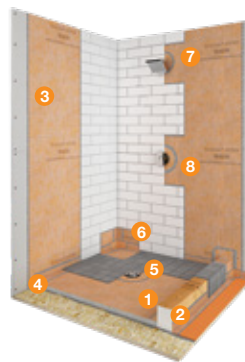

Includes	Description	Quantity	
		48" x 48"	38" x 60"
1 KERDI-SHOWER-T/-TS/-TT	Shower Tray	1	1
2 KERDI-BOARD-SC	Shower Curb 122 cm x 15 cm x 11.5 cm - 48" x 6" x 4-1/2"	1	
	KERDI-BOARD-SC		2
3 KERDI 10 M	Waterproofing membrane 1 m x 10 m = 10 m ² - 3' 3" x 33' = 108 ft ²	1	1
4 KERDI-BAND	Waterproofing strip 125 mm x 10 m - 5" x 33'	1	1
5 KERDI-DRAIN	Flange with 50 mm - 2" outlet and stainless steel grate (E)	1	1
6 KERDI-KERECK-F	Preformed waterproofing corners	4 inside and 2 outside	
7 KERDI-SEAL-PS	Pipe seal 20 mm - 3/4"	1	
8 KERDI-SEAL-MV	Mixing valve seal 114 mm - 4-1/4"	1	

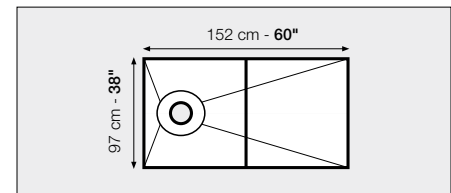
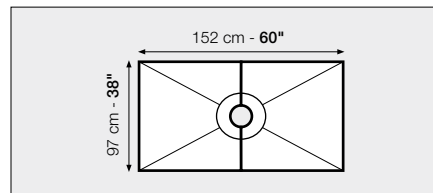
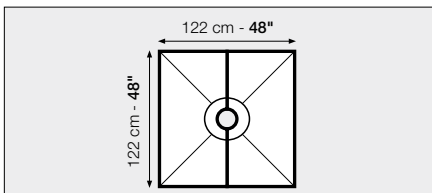

48" x 48" Kit - ABS or PVC			
Item No.	Drain Material	Grate finish	\$ / Kit
KSK 1220 ABS E	ABS	E	641.24
KSK 1220 PVC E	PVC	E	641.24

38" x 60" Kit - ABS or PVC			
Item No.	Drain Material	Grate finish	\$ / Kit
KSK 965 1525 ABS E	ABS	E	695.99
KSK 965 1525 PVC E	PVC	E	695.99

38" x 60" Kit off-center - ABS or PVC			
Item No.	Drain Material	Grate finish	\$ / Kit
KSK 965 1525S ABSE	ABS	E	695.99
KSK 965 1525S PVCE	PVC	E	695.99

⚠ WARNING: Cancer and Reproductive Harm - www.P65Warnings.ca.gov

Note: Tray features off-center drain placement: 10" (25.4 cm) o.c. from end of tray.



Schluter®-KERDI-SHOWER-KIT

WITHOUT THE GRATE

This kit contains all the elements of the complete KERDI-SHOWER-KIT except the drain grate. This simplifies the stocking of a wide variety of KERDI-SHOWER-T/-TS/-TT tray and KERDI-DRAIN grate combinations.

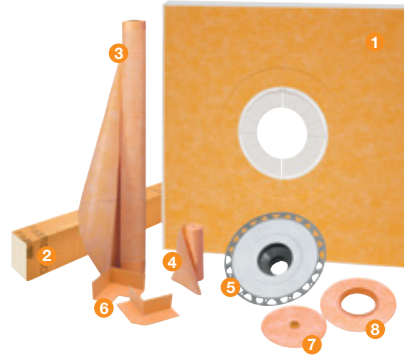

KERDI-DRAIN Grates

sold separately

See pages 134-137

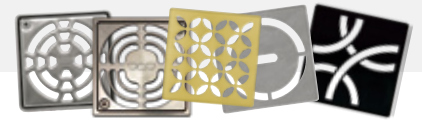

Includes		Description	Quantity			
			48" x 48"	38" x 60"	48" x 72"	72" x 72"
1	KERDI-SHOWER-T/-TS/-TT	Shower Tray	1	1	1	1
2	KERDI-BOARD-SC	Shower Curb 122 cm x 15 cm x 11.5 cm - 48" x 6" x 4-1/2"	1			
	KERDI-BOARD-SC	Shower Curb 97 cm x 15 cm x 11.5 cm - 38" x 6" x 4-1/2"		2	2	2
3	KERDI 5 M	Waterproofing membrane 1 m x 5 m = 5 m ² - 3' 3" x 16' 5" = 54 ft ²				1
	KERDI 10 M	Waterproofing membrane 1 m x 10 m = 10 m ² - 3' 3" x 33' = 108 ft ²	1	1		1
	KERDI 12 M	Waterproofing membrane 1 m x 12 m = 12 m ² - 3' 3" x 39' 4" = 128 ft ²			1	
4	KERDI-BAND	Waterproofing strip 125 mm x 10 m - 5" x 33'			2	
5	KERDI-DRAIN Flange	Flange with 50 mm - 2" outlet	1	1	1	1
6	KERDI-KERECK-F	Preformed waterproofing corners	4 inside and 2 outside			
7	KERDI-SEAL-PS	Pipe seal 20 mm - 3/4"	1			
8	KERDI-SEAL-MV	Mixing valve seal 114 mm - 4-1/4"	1			

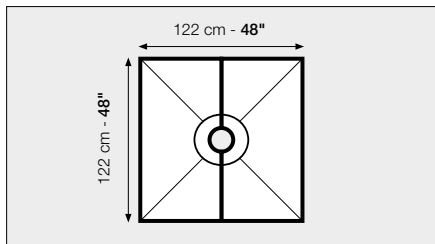

48" x 48" Kit - ABS or PVC		
Item No.	Drain Material	\$ / Kit
KSK 1220 ABS	ABS	583.34
KSK 1220 PVC	PVC	583.34

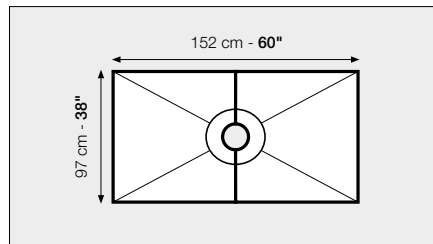

38" x 60" Kit - ABS or PVC		
Item No.	Drain Material	\$ / Kit
KSK 965 1525 ABS	ABS	637.80
KSK 965 1525 PVC	PVC	637.80

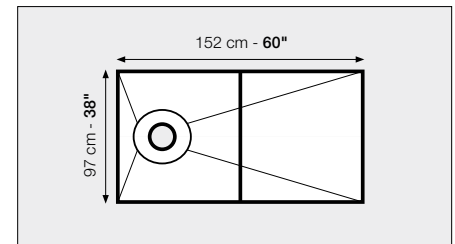

38" x 60" Kit off-center - ABS or PVC		
Item No.	Drain Material	\$ / Kit
KSK 965 1525S ABS	ABS	637.80
KSK 965 1525S PVC	PVC	637.80

Note: Tray features off-center drain placement: 10" (25.4 cm) o.c. from end of tray.

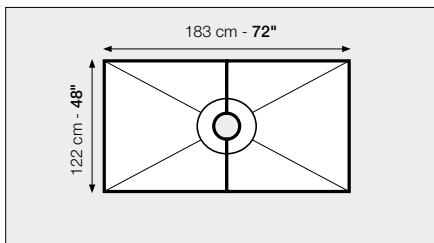

48" x 72" Kit - ABS or PVC		
Item No.	Drain Material	\$ / Kit
KSK 1220 1830 ABS	ABS	858.01
KSK 1220 1830 PVC	PVC	858.01

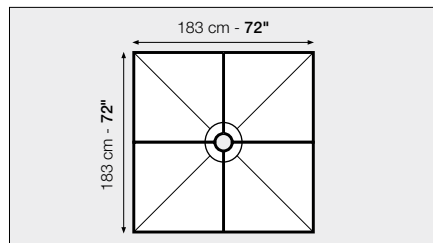

72" x 72" Kit - ABS or PVC		
Item No.	Drain Material	\$ / Kit
KSK 1830 ABS	ABS	1,000.50
KSK 1830 PVC	PVC	1,000.50

WARNING: Cancer and Reproductive Harm - www.P65Warnings.ca.gov

Schluter®-KERDI-SHOWER-KIT

WITHOUT THE DRAIN

This kit contains all the elements of the complete KERDI-SHOWER-KIT except the KERDI-DRAIN. This simplifies the stocking of a wide variety of KERDI-SHOWER-T/-TS/-TT trays and KERDI-DRAIN combinations.

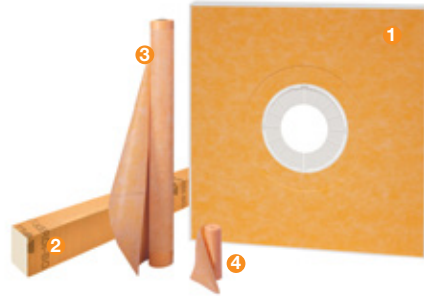

KERDI-DRAIN grates and flanges sold separately

Grates - See pages 134-137
Flanges - See pages 138-141

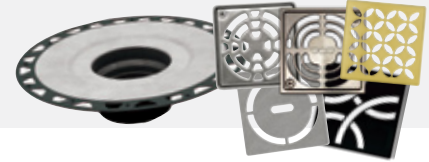

Schluter®-KERDI-SHOWER-KIT - WITHOUT THE DRAIN

Includes	Description	Quantity			
		48" x 48"	38" x 60"	48" x 72"	72" x 72"
① KERDI-SHOWER-T/-TS/-TT	Shower Tray	1	1	1	1
② KERDI-BOARD-SC	Shower Curb 122 cm x 15 cm x 11.5 cm - 48" x 6" x 4-1/2"	1			
	KERDI-BOARD-SC		2	2	2
③ KERDI 5 M	Waterproofing membrane 1 m x 5 m = 5 m ² - 3' 3" x 16' 5" = 54 ft²				1
	KERDI 10 M	1	1		1
	KERDI 12 M			1	
④ KERDI-BAND	Waterproofing strip 125 mm x 10 m - 5" x 33'	1	1	2	2

Tray size	Item No.	\$ / Kit
122 cm x 122 cm - 48" x 48"	KSK 1220	492.61
97 cm x 152 cm - 38" x 60"	KSK 965 1525	547.06
97 cm x 152 cm - 38" x 60" off-center drain	KSK 965 1525S	547.06
122 cm x 183 cm - 48" x 72"	KSK 1220 1830	767.27
183 cm x 183 cm - 72" x 72"	KSK 1830	909.77

⚠ WARNING: Cancer and Reproductive Harm - www.P65Warnings.ca.gov



Schluter®-KERDI-TUBKIT

The **Schluter®-KERDI-TUBKIT** contains all the components necessary to create a fully waterproof and vapor tight bathtub surround assembly.



Schluter®-KERDI-TUBKIT		
Includes	Description	Quantity
1 KERDI 7M	Waterproofing membrane 1 m x 7 m = 7 m ² - 3' 3" x 23' = 75 ft ²	1
2 KERDI-BAND	Waterproofing strip 125 mm x 5 m - 5" x 16' 5"	1
3 KERDI-SEAL-PS	Pipe seal 20 mm - 3/4"	1
4 KERDI-SEAL-MV	Mixing valve seal 114 mm - 4-1/4"	1
5 KERDI-FIX	Sealing and bonding compound, bright white (290 ml – 9.81 fl oz)	1

Item No.	\$ / Kit
KKB7	268.66

⚠ WARNING: Reproductive Harm - www.P65Warnings.ca.gov

Schluter®-KERDI-BOARD-KIT

The **Schluter®-KERDI-BOARD-KIT** contains KERDI-BOARD panels and all the other components necessary to create a fully waterproof and vapor tight tile application around bathtubs and acrylic shower bases, all in one convenient package.

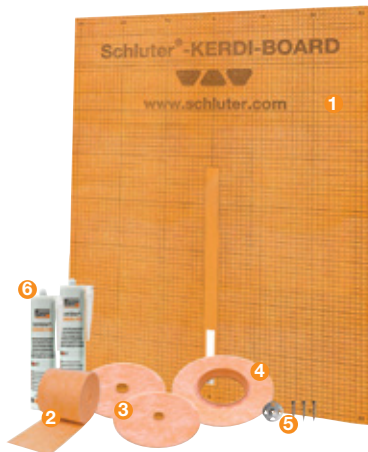

Schluter®-KERDI-BOARD-KIT

Includes	Description	Quantity
① KERDI-BOARD	Waterproof building panel 1.25 cm x 122 cm x 97 cm - 1/2" x 48" x 38" Total coverage = 9.4 m ² - 101 ft ²	8
② KERDI-BAND	Waterproofing strip 125 mm x 30 m - 5" x 98' 5"	1
③ KERDI-SEAL-PS	Pipe seal	1x 12.5 mm - 1/2" 1x 20 mm - 3/4"
④ KERDI-SEAL-MV	Mixing valve seal 114 mm - 4-1/4"	1
⑤ KERDI-BOARD-ZT/-ZS	Screws and washers	140
⑥ KERDI-FIX	Sealing and bonding compound, bright white (290 ml - 9.81 fl oz)	2

Item No.	\$ / Kit
KBKIT	729.03

⚠ WARNING: Cancer and Reproductive Harm www.P65Warnings.ca.gov





Shower Accessories

Accessories are used to enhance tiled shower applications, providing shelving, splashguards at the entrances to curbless showers, support channels for glass walls, and wall finishing that eliminates the need to cut wedges of tile in KERDI-LINE applications.





Schluter®-SHELF-W

Schluter®-SHELF-W is a rectangular shelf designed for tiled walls. The shelf is made of either brushed stainless steel, or color-coated aluminum in a choice of 9 TRENDLINE colors. SHELF-W features a double anchoring leg for installation in tandem with tile. Matching KERDI-DRAIN and KERDI-LINE grates are also available.

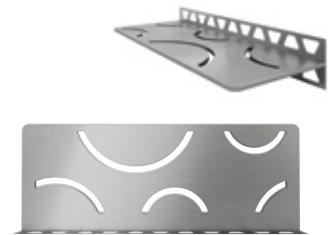
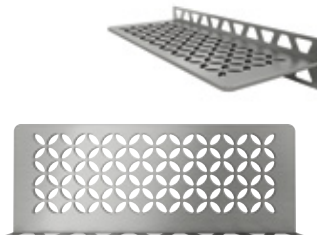
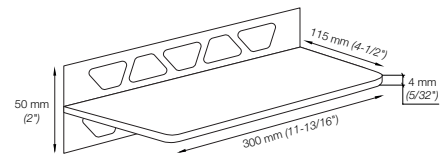
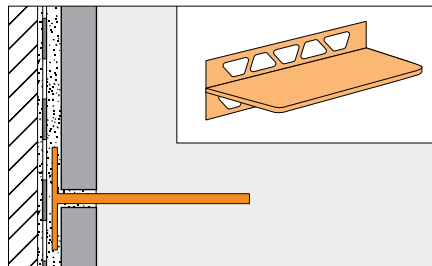

Schluter®-SHELF-W		
FLORAL		
Item No.	Finish	\$ / Unit
Stainless steel		
SWS1 D5 EB	Brushed stainless steel (EB)	139.11
Color-coated aluminum		
SWS1 D5 MBW	Matte white (MBW)	118.53
SWS1 D5 TSI	Ivory (TSI)	118.53
SWS1 D5 TSBG	Greige (TSBG)	118.53
SWS1 D5 TSC	Cream (TSC)	118.53
SWS1 D5 TSOB	Bronze (TSOB)	118.53
SWS1 D5 TSSG	Stone grey (TSSG)	118.53
SWS1 D5 TSG	Pewter (TSG)	118.53
SWS1 D5 TSDA	Dark anthracite (TSDA)	118.53
SWS1 D5 MGS	Matte black (MGS)	118.53

Schluter®-SHELF-W		
CURVE		
Item No.	Finish	\$ / Unit
Stainless steel		
SWS1 D6 EB	Brushed stainless steel (EB)	133.04
Color-coated aluminum		
SWS1 D6 MBW	Matte white (MBW)	99.18
SWS1 D6 TSI	Ivory (TSI)	99.18
SWS1 D6 TSBG	Greige (TSBG)	99.18
SWS1 D6 TSC	Cream (TSC)	99.18
SWS1 D6 TSOB	Bronze (TSOB)	99.18
SWS1 D6 TSSG	Stone grey (TSSG)	99.18
SWS1 D6 TSG	Pewter (TSG)	99.18
SWS1 D6 TSDA	Dark anthracite (TSDA)	99.18
SWS1 D6 MGS	Matte black (MGS)	99.18

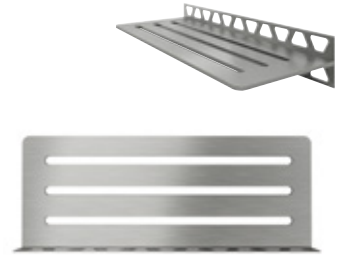
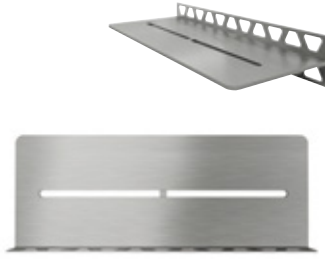

Schluter®-SHELF-W		
PURE		
Item No.	Finish	\$ / Unit
Stainless steel		
SWS1 D7 EB	Brushed stainless steel (EB)	133.04
Color-coated aluminum		
SWS1 D7 MBW	Matte white (MBW)	99.18
SWS1 D7 TSI	Ivory (TSI)	99.18
SWS1 D7 TSBG	Greige (TSBG)	99.18
SWS1 D7 TSC	Cream (TSC)	99.18
SWS1 D7 TSOB	Bronze (TSOB)	99.18
SWS1 D7 TSSG	Stone grey (TSSG)	99.18
SWS1 D7 TSG	Pewter (TSG)	99.18
SWS1 D7 TSDA	Dark anthracite (TSDA)	99.18
SWS1 D7 MGS	Matte black (MGS)	99.18

Schluter®-SHELF-W		
WAVE		
Item No.	Finish	\$ / Unit
Stainless steel		
SWS1 D10 EB	Brushed stainless steel (EB)	139.11
Color-coated aluminum		
SWS1 D10 MBW	Matte white (MBW)	118.53
SWS1 D10 TSI	Ivory (TSI)	118.53
SWS1 D10 TSBG	Greige (TSBG)	118.53
SWS1 D10 TSC	Cream (TSC)	118.53
SWS1 D10 TSOB	Bronze (TSOB)	118.53
SWS1 D10 TSSG	Stone grey (TSSG)	118.53
SWS1 D10 TSG	Pewter (TSG)	118.53
SWS1 D10 TSDA	Dark anthracite (TSDA)	118.53
SWS1 D10 MGS	Matte black (MGS)	118.53

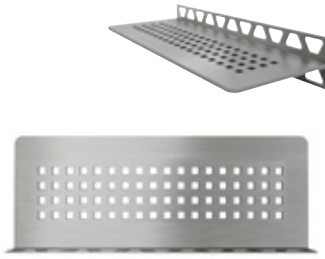

Schluter®-SHELF-W		
SQUARE		
Item No.	Finish	\$ / Unit
Stainless steel		
SWS1 D3 EB	Brushed stainless steel (EB)	139.11
Color-coated aluminum		
SWS1 D3 MBW	Matte white (MBW)	118.53
SWS1 D3 TSI	Ivory (TSI)	118.53
SWS1 D3 TSBG	Greige (TSBG)	118.53
SWS1 D3 TSC	Cream (TSC)	118.53
SWS1 D3 TSOB	Bronze (TSOB)	118.53
SWS1 D3 TSSG	Stone grey (TSSG)	118.53
SWS1 D3 TSG	Pewter (TSG)	118.53
SWS1 D3 TSDA	Dark anthracite (TSDA)	118.53
SWS1 D3 MGS	Matte black (MGS)	118.53



Stainless steel

Color-coated aluminum





Schluter®-SHELF-E

Schluter®-SHELF-E is a corner shelf designed for tiled walls. The shelf is made of either brushed stainless steel, or color-coated aluminum in a choice of 9 TRENDLINE colors. SHELF-E features 3/32" (2 mm) -thick anchoring tabs which allow for easy installation either in tandem with tile or as a retrofit application. Matching KERDI-DRAIN and KERDI-LINE grates are also available.

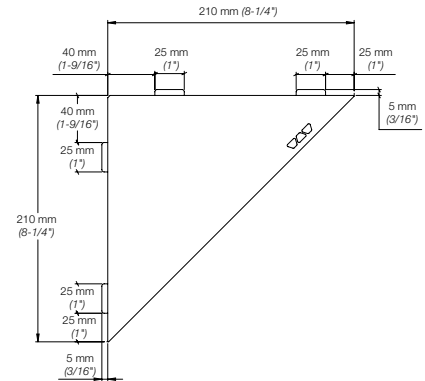
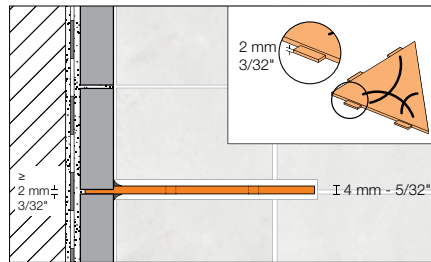

Triangular Corner Shelf

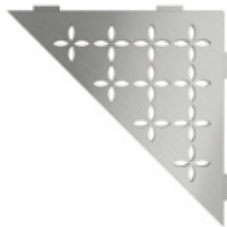

Schluter®-SHELF-E		
FLORAL		
Item No.	Finish	\$ / Unit
Stainless steel		
SES1 D5 EB	Brushed stainless steel (EB)	119.75
Color-coated aluminum		
SES1 D5 MBW	Matte white (MBW)	90.72
SES1 D5 TSI	Ivory (TSI)	90.72
SES1 D5 TSBG	Greige (TSBG)	90.72
SES1 D5 TSC	Cream (TSC)	90.72
SES1 D5 TSOB	Bronze (TSOB)	90.72
SES1 D5 TSSG	Stone grey (TSSG)	90.72
SES1 D5 TSG	Pewter (TSG)	90.72
SES1 D5 TSDA	Dark anthracite (TSDA)	90.72
SES1 D5 MGS	Matte black (MGS)	90.72

Schluter®-SHELF-E		
CURVE		
Item No.	Finish	\$ / Unit
Stainless steel		
SES1 D6 EB	Brushed stainless steel (EB)	114.91
Color-coated aluminum		
SES1 D6 MBW	Matte white (MBW)	84.66
SES1 D6 TSI	Ivory (TSI)	84.66
SES1 D6 TSBG	Greige (TSBG)	84.66
SES1 D6 TSC	Cream (TSC)	84.66
SES1 D6 TSOB	Bronze (TSOB)	84.66
SES1 D6 TSSG	Stone grey (TSSG)	84.66
SES1 D6 TSG	Pewter (TSG)	84.66
SES1 D6 TSDA	Dark anthracite (TSDA)	84.66
SES1 D6 MGS	Matte black (MGS)	84.66

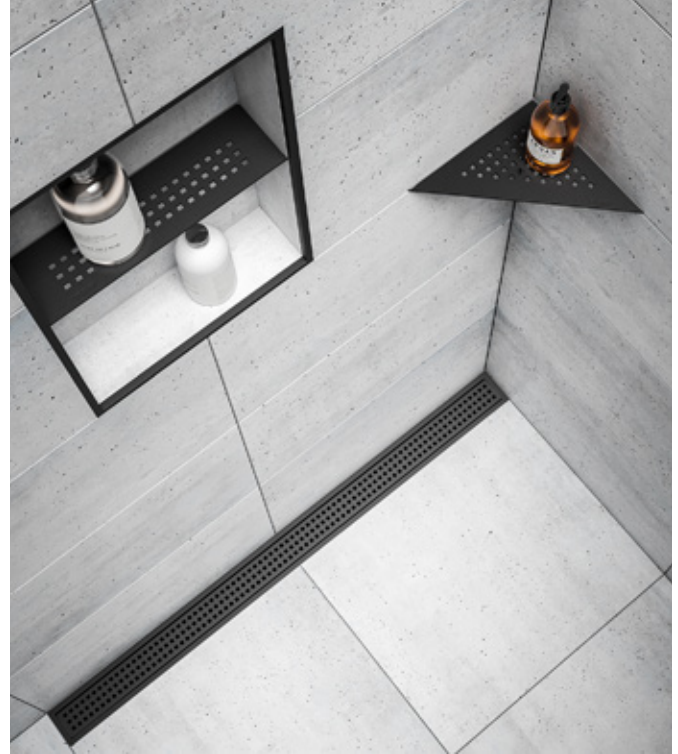

Schluter®-SHELF-E		
PURE		
Item No.	Finish	\$ / Unit
Stainless steel		
SES1 D7 EB	Brushed stainless steel (EB)	114.91
Color-coated aluminum		
SES1 D7 MBW	Matte white (MBW)	84.66
SES1 D7 TSI	Ivory (TSI)	84.66
SES1 D7 TSBG	Greige (TSBG)	84.66
SES1 D7 TSC	Cream (TSC)	84.66
SES1 D7 TSOB	Bronze (TSOB)	84.66
SES1 D7 TSSG	Stone grey (TSSG)	84.66
SES1 D7 TSG	Pewter (TSG)	84.66
SES1 D7 TSDA	Dark anthracite (TSDA)	84.66
SES1 D7 MGS	Matte black (MGS)	84.66

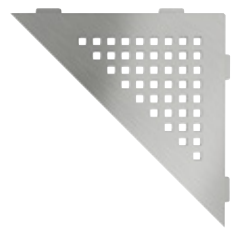

Schluter®-SHELF-E		
WAVE		
Item No.	Finish	\$ / Unit
Stainless steel		
SES1 D10 EB	Brushed stainless steel (EB)	119.75
Color-coated aluminum		
SES1 D10 MBW	Matte white (MBW)	90.72
SES1 D10 TSI	Ivory (TSI)	90.72
SES1 D10 TSBG	Greige (TSBG)	90.72
SES1 D10 TSC	Cream (TSC)	90.72
SES1 D10 TSOB	Bronze (TSOB)	90.72
SES1 D10 TSSG	Stone grey (TSSG)	90.72
SES1 D10 TSG	Pewter (TSG)	90.72
SES1 D10 TSDA	Dark anthracite (TSDA)	90.72
SES1 D10 MGS	Matte black (MGS)	90.72

Schluter®-SHELF-E		
SQUARE		
Item No.	Finish	\$ / Unit
Stainless steel		
SES1 D3 EB	Brushed stainless steel (EB)	119.75
Color-coated aluminum		
SES1 D3 MBW	Matte white (MBW)	90.72
SES1 D3 TSI	Ivory (TSI)	90.72
SES1 D3 TSBG	Greige (TSBG)	90.72
SES1 D3 TSC	Cream (TSC)	90.72
SES1 D3 TSOB	Bronze (TSOB)	90.72
SES1 D3 TSSG	Stone grey (TSSG)	90.72
SES1 D3 TSG	Pewter (TSG)	90.72
SES1 D3 TSDA	Dark anthracite (TSDA)	90.72
SES1 D3 MGS	Matte black (MGS)	90.72

Stainless steel

Color-coated aluminum



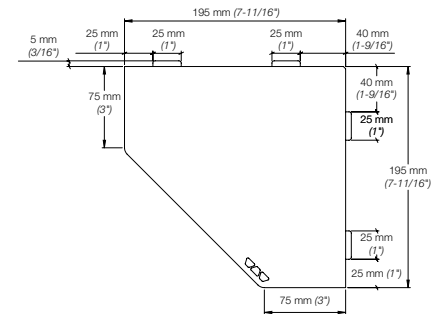

Pentagonal Corner Shelf

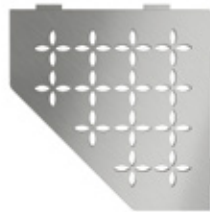

Schluter®-SHELF-E		
FLORAL		
Item No.	Finish	\$ / Unit
Stainless steel		
SES2 D5 EB	Brushed stainless steel (EB)	119.75
Color-coated aluminum		
SES2 D5 MBW	Matte white (MBW)	102.81
SES2 D5 TSI	Ivory (TSI)	102.81
SES2 D5 TSBG	Greige (TSBG)	102.81
SES2 D5 TSC	Cream (TSC)	102.81
SES2 D5 TSOB	Bronze (TSOB)	102.81
SES2 D5 TSSG	Stone grey (TSSG)	102.81
SES2 D5 TSG	Pewter (TSG)	102.81
SES2 D5 TSDA	Dark anthracite (TSDA)	102.81
SES2 D5 MGS	Matte black (MGS)	102.81

Schluter®-SHELF-E		
CURVE		
Item No.	Finish	\$ / Unit
Stainless steel		
SES2 D6 EB	Brushed stainless steel (EB)	114.91
Color-coated aluminum		
SES2 D6 MBW	Matte white (MBW)	95.56
SES2 D6 TSI	Ivory (TSI)	95.56
SES2 D6 TSBG	Greige (TSBG)	95.56
SES2 D6 TSC	Cream (TSC)	95.56
SES2 D6 TSOB	Bronze (TSOB)	95.56
SES2 D6 TSSG	Stone grey (TSSG)	95.56
SES2 D6 TSG	Pewter (TSG)	95.56
SES2 D6 TSDA	Dark anthracite (TSDA)	95.56
SES2 D6 MGS	Matte black (MGS)	95.56

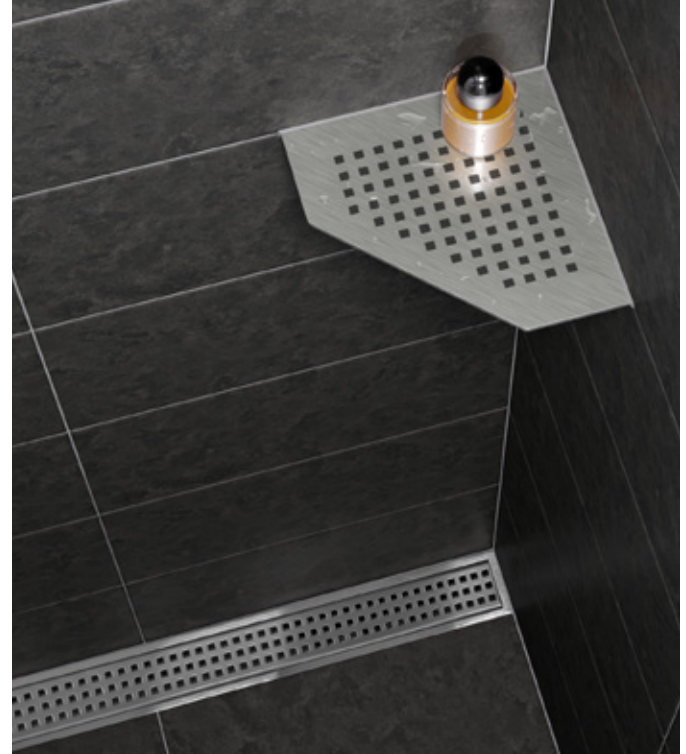

Schluter®-SHELF-E		
PURE		
Item No.	Finish	\$ / Unit
Stainless steel		
SES2 D7 EB	Brushed stainless steel (EB)	114.91
Color-coated aluminum		
SES2 D7 MBW	Matte white (MBW)	95.56
SES2 D7 TSI	Ivory (TSI)	95.56
SES2 D7 TSBG	Greige (TSBG)	95.56
SES2 D7 TSC	Cream (TSC)	95.56
SES2 D7 TSOB	Bronze (TSOB)	95.56
SES2 D7 TSSG	Stone grey (TSSG)	95.56
SES2 D7 TSG	Pewter (TSG)	95.56
SES2 D7 TSDA	Dark anthracite (TSDA)	95.56
SES2 D7 MGS	Matte black (MGS)	95.56

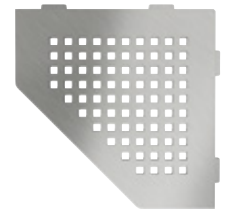

Schluter®-SHELF-E		
WAVE		
Item No.	Finish	\$ / Unit
Stainless steel		
SES2 D10 EB	Brushed stainless steel (EB)	119.75
Color-coated aluminum		
SES2 D10 MBW	Matte white (MBW)	102.81
SES2 D10 TSI	Ivory (TSI)	102.81
SES2 D10 TSBG	Greige (TSBG)	102.81
SES2 D10 TSC	Cream (TSC)	102.81
SES2 D10 TSOB	Bronze (TSOB)	102.81
SES2 D10 TSSG	Stone grey (TSSG)	102.81
SES2 D10 TSG	Pewter (TSG)	102.81
SES2 D10 TSDA	Dark anthracite (TSDA)	102.81
SES2 D10 MGS	Matte black (MGS)	102.81

Schluter®-SHELF-E		
SQUARE		
Item No.	Finish	\$ / Unit
Stainless steel		
SES2 D3 EB	Brushed stainless steel (EB)	119.75
Color-coated aluminum		
SES2 D3 MBW	Matte white (MBW)	102.81
SES2 D3 TSI	Ivory (TSI)	102.81
SES2 D3 TSBG	Greige (TSBG)	102.81
SES2 D3 TSC	Cream (TSC)	102.81
SES2 D3 TSOB	Bronze (TSOB)	102.81
SES2 D3 TSSG	Stone grey (TSSG)	102.81
SES2 D3 TSG	Pewter (TSG)	102.81
SES2 D3 TSDA	Dark anthracite (TSDA)	102.81
SES2 D3 MGS	Matte black (MGS)	102.81

Stainless steel

Color-coated aluminum



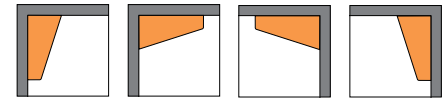
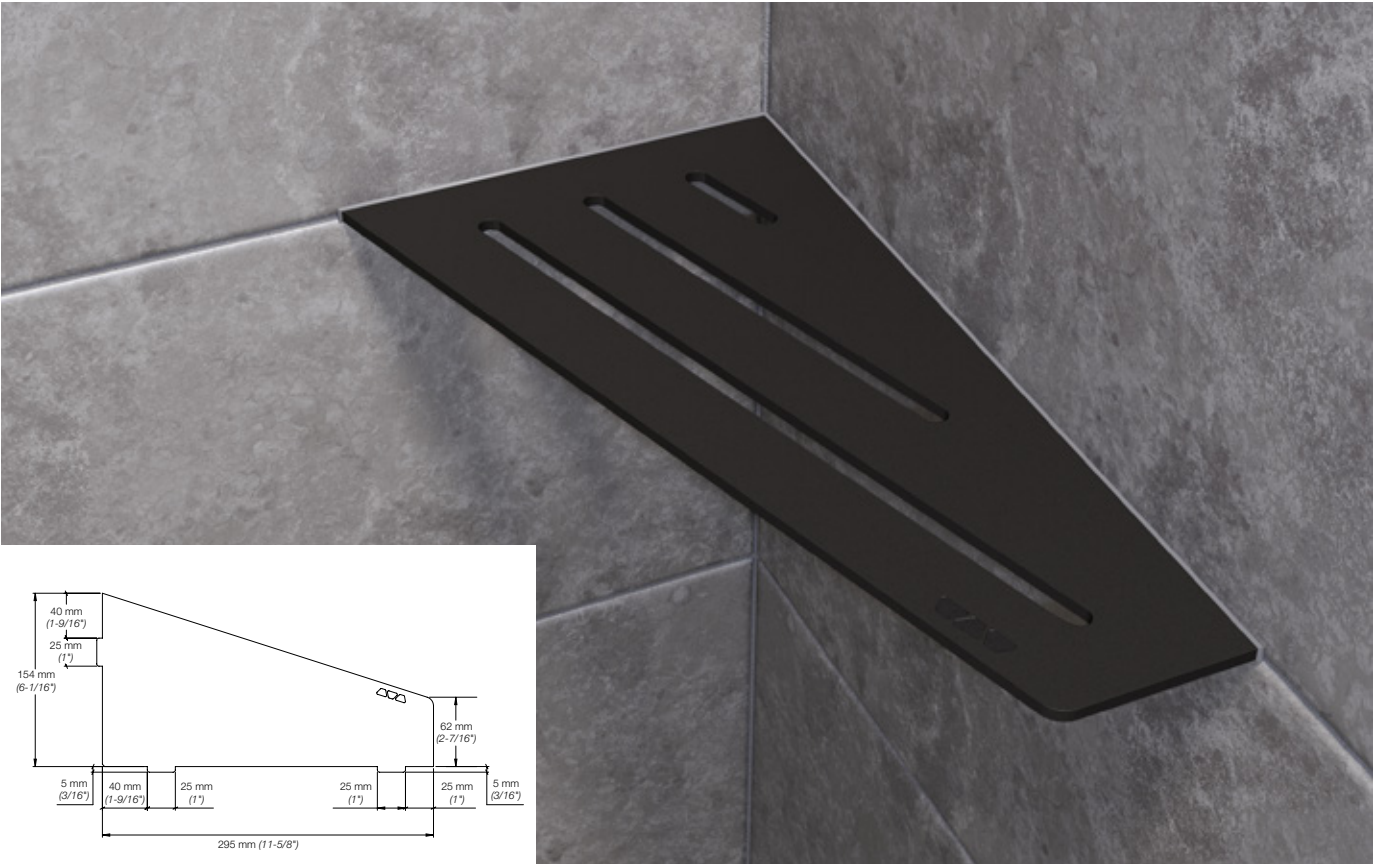

Quadrilateral Corner Shelf



Schluter®-SHELF-E		
FLORAL		
Item No.	Finish	\$ / Unit
Stainless steel		
SES3 D5 EB	Brushed stainless steel (EB)	156.03
Color-coated aluminum		
SES3 D5 MBW	Matte white (MBW)	119.75
SES3 D5 TSI	Ivory (TSI)	119.75
SES3 D5 TSBG	Greige (TSBG)	119.75
SES3 D5 TSC	Cream (TSC)	119.75
SES3 D5 TSOB	Bronze (TSOB)	119.75
SES3 D5 TSSG	Stone grey (TSSG)	119.75
SES3 D5 TSG	Pewter (TSG)	119.75
SES3 D5 TSDA	Dark anthracite (TSDA)	119.75
SES3 D5 MGS	Matte black (MGS)	119.75

Schluter®-SHELF-E		
CURVE		
Item No.	Finish	\$ / Unit
Stainless steel		
SES3 D6 EB	Brushed stainless steel (EB)	156.03
Color-coated aluminum		
SES3 D6 MBW	Matte white (MBW)	107.64
SES3 D6 TSI	Ivory (TSI)	107.64
SES3 D6 TSBG	Greige (TSBG)	107.64
SES3 D6 TSC	Cream (TSC)	107.64
SES3 D6 TSOB	Bronze (TSOB)	107.64
SES3 D6 TSSG	Stone grey (TSSG)	107.64
SES3 D6 TSG	Pewter (TSG)	107.64
SES3 D6 TSDA	Dark anthracite (TSDA)	107.64
SES3 D6 MGS	Matte black (MGS)	107.64



Schluter®-SHELF-E		
PURE		
Item No.	Finish	\$ / Unit
Stainless steel		
SES3 D7 EB	Brushed stainless steel (EB)	156.03
Color-coated aluminum		
SES3 D7 MBW	Matte white (MBW)	107.64
SES3 D7 TSI	Ivory (TSI)	107.64
SES3 D7 TSBG	Greige (TSBG)	107.64
SES3 D7 TSC	Cream (TSC)	107.64
SES3 D7 TSOB	Bronze (TSOB)	107.64
SES3 D7 TSSG	Stone grey (TSSG)	107.64
SES3 D7 TSG	Pewter (TSG)	107.64
SES3 D7 TSDA	Dark anthracite (TSDA)	107.64
SES3 D7 MGS	Matte black (MGS)	107.64



Schluter®-SHELF-E		
WAVE		
Item No.	Finish	\$ / Unit
Stainless steel		
SES3 D10 EB	Brushed stainless steel (EB)	156.03
Color-coated aluminum		
SES3 D10 MBW	Matte white (MBW)	119.75
SES3 D10 TSI	Ivory (TSI)	119.75
SES3 D10 TSBG	Greige (TSBG)	119.75
SES3 D10 TSC	Cream (TSC)	119.75
SES3 D10 TSOB	Bronze (TSOB)	119.75
SES3 D10 TSSG	Stone grey (TSSG)	119.75
SES3 D10 TSG	Pewter (TSG)	119.75
SES3 D10 TSDA	Dark anthracite (TSDA)	119.75
SES3 D10 MGS	Matte black (MGS)	119.75

Schluter®-SHELF-E		
SQUARE		
Item No.	Finish	\$ / Unit
Stainless steel		
SES3 D3 EB	Brushed stainless steel (EB)	156.03
Color-coated aluminum		
SES3 D3 MBW	Matte white (MBW)	119.75
SES3 D3 TSI	Ivory (TSI)	119.75
SES3 D3 TSBG	Greige (TSBG)	119.75
SES3 D3 TSC	Cream (TSC)	119.75
SES3 D3 TSOB	Bronze (TSOB)	119.75
SES3 D3 TSSG	Stone grey (TSSG)	119.75
SES3 D3 TSG	Pewter (TSG)	119.75
SES3 D3 TSDA	Dark anthracite (TSDA)	119.75
SES3 D3 MGS	Matte black (MGS)	119.75

Stainless steel

Color-coated aluminum





Schluter®-SHELF-N

Schluter®-SHELF-N is a rectangular shelf designed to fit into Schluter®-KERDI-BOARD-SN prefabricated niches. The shelf is made of either brushed stainless steel, or color-coated aluminum in a choice of 9 TRENDLINE colors. SHELF-N can be easily installed in tandem with tile. Matching KERDI-DRAIN and KERDI-LINE grates are also available.

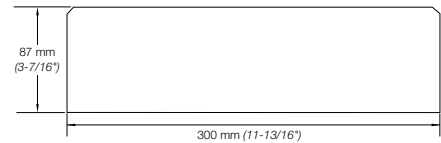
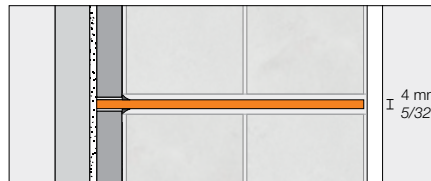

Schluter®-SHELF-N		
FLORAL		
Item No.	Finish	\$ / Unit
Stainless steel		
SNS1 D5 EB	Brushed stainless steel (EB)	133.04
Color-coated aluminum		
SNS1 D5 MBW	Matte white (MBW)	102.81
SNS1 D5 TSI	Ivory (TSI)	102.81
SNS1 D5 TSBG	Greige (TSBG)	102.81
SNS1 D5 TSC	Cream (TSC)	102.81
SNS1 D5 TSOB	Bronze (TSOB)	102.81
SNS1 D5 TSSG	Stone grey (TSSG)	102.81
SNS1 D5 TSG	Pewter (TSG)	102.81
SNS1 D5 TSDA	Dark anthracite (TSDA)	102.81
SNS1 D5 MGS	Matte black (MGS)	102.81

Schluter®-SHELF-N		
CURVE		
Item No.	Finish	\$ / Unit
Stainless steel		
SNS1 D6 EB	Brushed stainless steel (EB)	127.00
Color-coated aluminum		
SNS1 D6 MBW	Matte white (MBW)	96.76
SNS1 D6 TSI	Ivory (TSI)	96.76
SNS1 D6 TSBG	Greige (TSBG)	96.76
SNS1 D6 TSC	Cream (TSC)	96.76
SNS1 D6 TSOB	Bronze (TSOB)	96.76
SNS1 D6 TSSG	Stone grey (TSSG)	96.76
SNS1 D6 TSG	Pewter (TSG)	96.76
SNS1 D6 TSDA	Dark anthracite (TSDA)	96.76
SNS1 D6 MGS	Matte black (MGS)	96.76



Schluter®-SHELVE-N		
PURE		
Item No.	Finish	\$ / Unit
Stainless steel		
SNS1 D7 EB	Brushed stainless steel (EB)	127.00
Color-coated aluminum		
SNS1 D7 MBW	Matte white (MBW)	96.76
SNS1 D7 TSI	Ivory (TSI)	96.76
SNS1 D7 TSBG	Greige (TSBG)	96.76
SNS1 D7 TSC	Cream (TSC)	96.76
SNS1 D7 TSOB	Bronze (TSOB)	96.76
SNS1 D7 TSSG	Stone grey (TSSG)	96.76
SNS1 D7 TSG	Pewter (TSG)	96.76
SNS1 D7 TSDA	Dark anthracite (TSDA)	96.76
SNS1 D7 MGS	Matte black (MGS)	96.76



Schluter®-SHELVE-N		
WAVE		
Item No.	Finish	\$ / Unit
Stainless steel		
SNS1 D10 EB	Brushed stainless steel (EB)	133.04
Color-coated aluminum		
SNS1 D10 MBW	Matte white (MBW)	102.81
SNS1 D10 TSI	Ivory (TSI)	102.81
SNS1 D10 TSBG	Greige (TSBG)	102.81
SNS1 D10 TSC	Cream (TSC)	102.81
SNS1 D10 TSOB	Bronze (TSOB)	102.81
SNS1 D10 TSSG	Stone grey (TSSG)	102.81
SNS1 D10 TSG	Pewter (TSG)	102.81
SNS1 D10 TSDA	Dark anthracite (TSDA)	102.81
SNS1 D10 MGS	Matte black (MGS)	102.81



Schluter®-SHELVE-N		
SQUARE		
Item No.	Finish	\$ / Unit
Stainless steel		
SNS1 D3 EB	Brushed stainless steel (EB)	133.04
Color-coated aluminum		
SNS1 D3 MBW	Matte white (MBW)	102.81
SNS1 D3 TSI	Ivory (TSI)	102.81
SNS1 D3 TSBG	Greige (TSBG)	102.81
SNS1 D3 TSC	Cream (TSC)	102.81
SNS1 D3 TSOB	Bronze (TSOB)	102.81
SNS1 D3 TSSG	Stone grey (TSSG)	102.81
SNS1 D3 TSG	Pewter (TSG)	102.81
SNS1 D3 TSDA	Dark anthracite (TSDA)	102.81
SNS1 D3 MGS	Matte black (MGS)	102.81

Stainless steel

Color-coated aluminum



Schluter®-SHOWERPROFILE-S

The **Schluter®-SHOWERPROFILE-S** is a two-part profile with a tapered edge, designed to cover adjoining tile edges that become exposed as the shower floor slopes to accommodate drainage to the Schluter®-KERDI-LINE. The tapered profile features a visible surface of brushed stainless steel and a fleece fabric on the reverse for bonding with the tile adhesive. It is designed to be inserted into the U-shaped groove of the matching hard PVC support profile. The profile can be used for lateral transitions to the wall or the adjoining floor.

Note: Tapered profiles with higher support profiles in the heights 9/16" (15 mm), 23/32" (18 mm), and 7/8" (22 mm) are available upon request for greater tile thicknesses. Please contact Customer Service for price and delivery times.

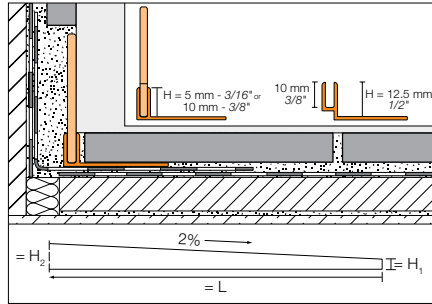

Schluter®-SHOWERPROFILE-SA				
Two-part tapered edging profile				
H = mm - in.	Item No.	H ₁ = mm - in.	H ₂ = mm - in.	\$/ Length
Length = 1.2 m - 47-1/4"				
5 - 3/16	SPSA 50 EB/120	6 - 1/4	30 - 1-3/16	77.61
Length = 1.6 m - 63"				
5 - 3/16	SPSA 50 EB/160	6 - 1/4	38 - 1-1/2	101.61
Length = 2 m - 78-3/4"				
5 - 3/16	SPSA 50 EB/200	6 - 1/4	46 - 1-13/16	226.21

Schluter®-SHOWERPROFILE-SB				
Two-part tapered edging profile				
H = mm - in.	Item No.	H ₁ = mm - in.	H ₂ = mm - in.	\$/ Length
Length = 1.2 m - 47-1/4"				
10 - 3/8	SPSB 100 EB/120	10 - 3/8	34 - 1-11/32	77.61
12.5 - 1/2	SPSB 125 EB/120	10 - 3/8	34 - 1-11/32	86.47
Length = 1.6 m - 63"				
10 - 3/8	SPSB 100 EB/160	10 - 3/8	42 - 1-21/32	101.61
12.5 - 1/2	SPSB 125 EB/160	10 - 3/8	42 - 1-21/32	112.55
Length = 2 m - 78-3/4"				
10 - 3/8	SPSB 100 EB/200	10 - 3/8	50 - 2	252.42
12.5 - 1/2	SPSB 125 EB/200	10 - 3/8	50 - 2	252.42

Schluter®-SHOWERPROFILE-R

The **Schluter®-SHOWERPROFILE-R** is a two part wall transition profile made of brushed stainless steel for covering the exposed wall area where the floor slopes down to a perimeter linear drain. A fleece fabric is laminated on the reverse of the profile for bonding with the tile adhesive. The two-part design of Schluter®-SHOWERPROFILE-R can be seamlessly adjusted to any height between 29/32" (23 mm) and 1-25/32" (45 mm) (available in two versions). The profile is available in lengths of 39" (1 m) and 55" (1.4 m) and can be cut to the desired length.

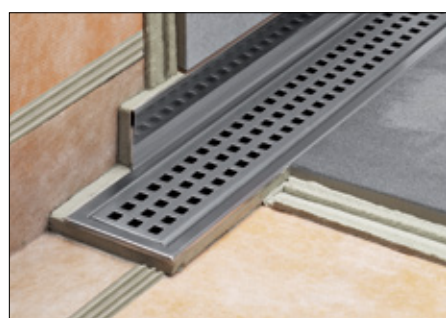
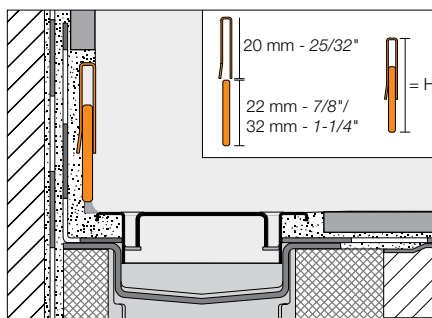

Schluter®-SHOWERPROFILE-R		
Two-part wall transition profile		
H = mm - in.	Item No.	\$/ Length
Length = 1 m - 39"		
23 - 35 - 29/32 - 1-3/8	SPRA 23 EB/100	94.43
33 - 45 - 1-5/16 - 1-25/32	SPRA 33 EB/100	102.91
Length = 1.4 m - 55"		
23 - 35 - 29/32 - 1-3/8	SPRA 23 EB/140	108.66
33 - 45 - 1-5/16 - 1-25/32	SPRA 33 EB/140	121.61



Schluter®-SHOWERPROFILE-WS

The **Schluter®-SHOWERPROFILE-WS** is a two-part profile that forms a splashguard at the entrance of barrier-free showers. The anodized aluminum support profile is set in conjunction with the tile covering and can be combined with either a semi-circular lip made of rigid PVC or a collapsible upright lip made of transparent polyurethane. Both variants allow for wheelchair accessibility.

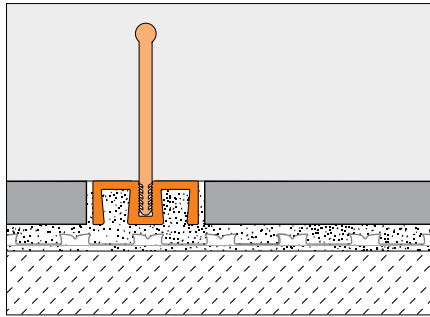

Schluter®-SHOWERPROFILE-WS		
Satin anodized aluminum support profile		
H = mm - in.	Item No.	\$ / Length
Length = 1 m - 39"		
8 - 5/16	SPWS 19 AE / 100	26.38
Length = 2.5 m - 8' 2-1/2"		
8 - 5/16	SPWS 19 AE	58.99

Schluter®-SHOWERPROFILE-WSC		
Semi-circular lip		
H = mm - in.	Item No.	\$ / Length
Length = 1 m - 39"		
8 - 5/16	SPWSC 16 GS / 100	13.78
Length = 2.5 m - 8' 2-1/2"		
8 - 5/16	SPWSC 16 GS	30.30

Schluter®-SHOWERPROFILE-WSL		
Straight lip		
H = mm - in.	Item No.	\$ / Length
Length = 1 m - 39"		
8 - 5/16	SPWSL 30 T / 100	16.65
Length = 2.5 m - 8' 2-1/2"		
8 - 5/16	SPWSL 30 T	36.62

ADA-Compliant

Note: SHOWERPROFILE-WS with the WSL straight lip insert is not ADA-compliant.

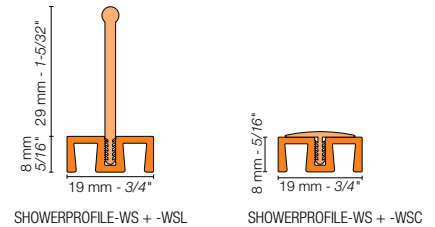

Schluter®-SHOWERPROFILE-WSK

The **Schluter®-SHOWERPROFILE-WSK** is a two-part profile that forms a splashguard at the entrance of barrier-free showers. The anodized aluminum support profile is adhered to existing coverings and can be combined with either a semi-circular lip made of rigid PVC or a collapsible upright lip made of transparent polyurethane. Both variants allow for wheelchair accessibility.

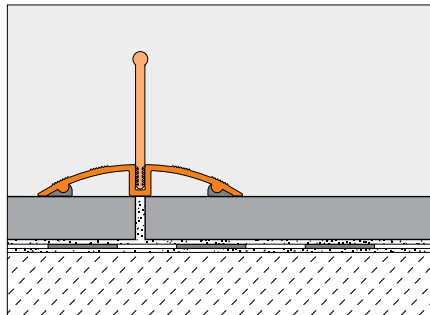

Schluter®-SHOWERPROFILE-WSK		
Satin anodized aluminum support profile		
H = mm - in.	Item No.	\$ / Length
Length = 1 m - 39"		
8 - 5/16	SPWSK 52 AE / 100	30.95
Length = 2.5 m - 8' 2-1/2"		
8 - 5/16	SPWSK 52 AE	70.57

Schluter®-SHOWERPROFILE-WSC		
Semi-circular lip		
H = mm - in.	Item No.	\$ / Length
Length = 1 m - 39"		
8 - 5/16	SPWSC 16 GS / 100	13.78
Length = 2.5 m - 8' 2-1/2"		
8 - 5/16	SPWSC 16 GS	30.30

Schluter®-SHOWERPROFILE-WSL		
Straight lip		
H = mm - in.	Item No.	\$ / Length
Length = 1 m - 39"		
8 - 5/16	SPWSL 30 T / 100	16.65
Length = 2.5 m - 8' 2-1/2"		
8 - 5/16	SPWSL 30 T	36.62

Schluter®-SHOWERPROFILE-WSK-EK

Schluter®-SHOWERPROFILE-WSK-EK		
End cap		
H = mm - in.	Item No.	\$ / Unit
8 - 5/16	EK / SPWSK 52 AE	5.66

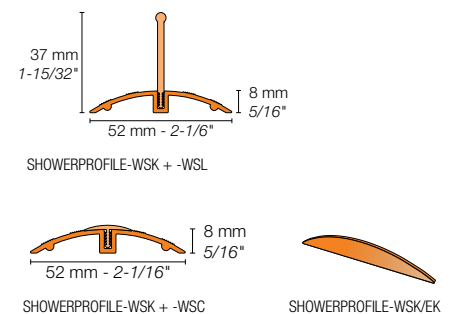

ADA-Compliant

Note: SHOWERPROFILE-WSK with the WSL straight lip insert is not ADA-compliant.

Schluter®-DECO-SG

Schluter®-DECO-SG is a decorative profile featuring a 1/2" (12.5 mm) or 9/16" (15 mm) -wide channel that creates a shadow gap between tile courses or other wall covering. The profile may also be used as a support channel for glass panels. The 1/2" (12.5 mm) wide channel accommodates glass panels up to a thickness of 3/8" (10 mm), and the 9/16" (15 mm) wide channel accommodates glass panels up to a thickness of 1/2" (12.5 mm). DECO-SG features a trapezoid-perforated anchoring leg that is secured in the bond coat beneath the tile.

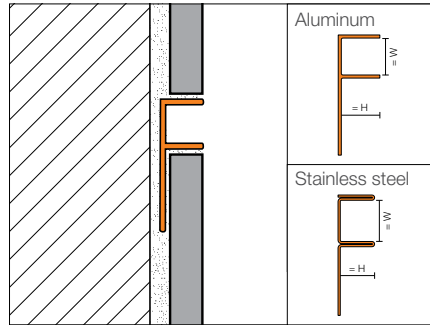

Schluter®-DECO-SG						
Length = 2.5 m - 8' 2-1/2"	Brushed stainless steel 304 (1.4301 = V2A) (EB)		Satin anodized aluminum (AE)		Bright chrome anodized aluminum (ACB)	
H = mm - in.	Item No.	\$ / Length	Item No.	\$ / Length	Item No.	\$ / Length
W: 12.5 mm - 1/2"						
8 - 5/16	SG 80 EB 12	81.58	SG 80 AE 12	22.53	SG 80 ACB 12	23.44
10 - 3/8	SG 100 EB 12	87.13	SG 100 AE 12	23.69	SG 100 ACB 12	24.54
11 - 7/16	SG 110 EB 12	90.13	SG 110 AE 12	24.34	SG 110 ACB 12	25.25
12.5 - 1/2	SG 125 EB 12	94.90	SG 125 AE 12	25.16	SG 125 ACB 12	26.07
W: 15 mm - 9/16"						
8 - 5/16	SG 80 EB 15	84.12	SG 80 AE 15	23.65	SG 80 ACB 15	24.60
10 - 3/8	SG 100 EB 15	89.61	SG 100 AE 15	24.89	SG 100 ACB 15	25.78
11 - 7/16	SG 110 EB 15	92.95	SG 110 AE 15	25.55	SG 110 ACB 15	26.51
12.5 - 1/2	SG 125 EB 15	96.48	SG 125 AE 15	26.43	SG 125 ACB 15	27.40

Schluter®-TRENDLINE Textured Color-coated Aluminum

Length = 2.5 m - 8' 2-1/2"	Textured color-coated aluminum	
H = mm - in.	Item No.	\$ / Length
W: 12.5 mm - 1/2"		
8 - 5/16	SG 80 + color* 12	43.80
10 - 3/8	SG 100 + color* 12	44.98
11 - 7/16	SG 110 + color* 12	45.60
12.5 - 1/2	SG 125 + color* 12	46.04
W: 15 mm - 9/16"		
8 - 5/16	SG 80 + color* 15	45.89
10 - 3/8	SG 100 + color* 15	47.07
11 - 7/16	SG 110 + color* 15	47.70
12.5 - 1/2	SG 125 + color* 15	48.13

***Color Codes**

Ivory	Greige	Stone grey	Cream	Bronze	Pewter	Dark anthracite	Matte white	Matte black

* To complete the item number, add the color code (e.g., SG 80 **TSI** 12).



Schluter®-DECO-SGC

Schluter®-DECO-SGC is a decorative profile featuring a 1/2" (12.5 mm) or 9/16" (15 mm) -wide channel used as a vertical support for glass panels in recessed showers that border on untiled walls that are plastered, creating a 90° angle between the glass partition and the untiled wall. The 1/2" (12.5 mm) wide channel accommodates glass panels up to a thickness of 3/8" (10 mm), and the 9/16" (15 mm) wide channel accommodates glass panels up to a thickness of 1/2" (12.5 mm). DECO-SGC features a trapezoid-perforated anchoring leg that is secured in the bond coat beneath the tile.

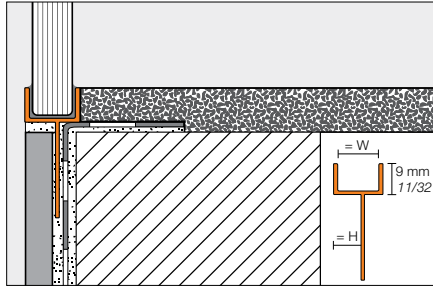

Schluter®-DECO-SGC			
Length = 2.5 m - 8' 2-1/2"	Satin anodized aluminum (AE)		
H = mm - in.	Item No.	\$/ Length	
W: 12.5 mm - 1/2"			
8 - 5/16	SGC 80 AE 12	24.34	
10 - 3/8	SGC 100 AE 12	25.59	
11 - 7/16	SGC 110 AE 12	26.29	
12.5 - 1/2	SGC 125 AE 12	27.18	
W: 15 mm - 9/16"			
8 - 5/16	SGC 80 AE 15	25.54	
10 - 3/8	SGC 100 AE 15	26.88	
11 - 7/16	SGC 110 AE 15	27.59	
12.5 - 1/2	SGC 125 AE 15	28.55	

Schluter®-KERDI-FIX

Schluter®-KERDI-FIX is a single-component sealing and bonding compound with a silane-modified polymer base. It is odor-neutral, UV- and weather-resistant, and contains no solvents. KERDI-FIX is elastomeric and bonds well to most materials, such as wood, stone, concrete, metal, glass, and many plastics. KERDI-FIX is suitable for bonding and Schluter®-KERDI waterproofing membrane and Schluter®-KERDI-BAND to fixed building elements. KERDI-FIX is also suitable for use as a sealant.



*Color Codes
<div style="display: flex; justify-content: space-around; align-items: center;"> <div style="text-align: center;"> <p>Bright white</p> </div> <div style="text-align: center;"> <p>Grey</p> </div> </div>

Schluter®-KERDI-FIX	
Cartridge (290 ml – 9.81 fl oz)	
Item No.	\$/ Unit
KERDIFIX / + color*	31.10

Schluter®-KERDI-FIX	
Tube (100 ml – 3.38 fl oz) - Grey (G)	
Item No.	\$/ Unit
KERDIFIX 100 G	18.06

⚠ WARNING: Reproductive Harm - www.P65Warnings.ca.gov



Schluter®-BEKOTEC

Modular screed system for conventional & radiant-heated screeds

BEKOTEC is a modular screed system that produces permanent flooring assemblies that are free from internal stresses. The BEKOTEC system is based on a studded polystyrene screed panel. The studs confine curing stresses to small modules, which eliminates curling and allows the installation of continuous screed surfaces without any wire reinforcement or control joints. BEKOTEC is ideal for hydronic radiant heating applications, as it provides thermal insulation, allows for hydronic radiant tube application without fasteners, and reduces thermal mass to produce a responsive system that can operate at a low temperature range. The BEKOTEC system can also be used in conjunction with common sound insulation materials to produce a flooring system with excellent sound attenuation properties.





Schluter®-BEKOTEC and Schluter®-BEKOTEC-F

The **Schluter®-BEKOTEC** family of products are lightweight modular screed systems that are used to create continuous screed surfaces without control joints or reinforcement and can also accommodate hydronic radiant heating tubes $3/8"$ - $5/8"$ ($10-16\text{ mm}$) O.D. They produce permanent flooring assemblies that are free from internal stresses by confining the shrinkage and curing stresses to smaller modules, which controls deformations such as curling and continuous cracks that are common in traditional screeds. Since they are floating systems, the assemblies can be customized to meet a range of heat and sound requirements. For use with ceramic tile, natural stone, or other surface coverings.

Schluter®-BEKOTEC is $1-3/8"$ (35 mm) -thick, and is made of expanded polystyrene.

Schluter®-BEKOTEC-F is $29/32"$ (23 mm) -thick, and is made of polystyrene foil.

EN/US/P = Screed panel

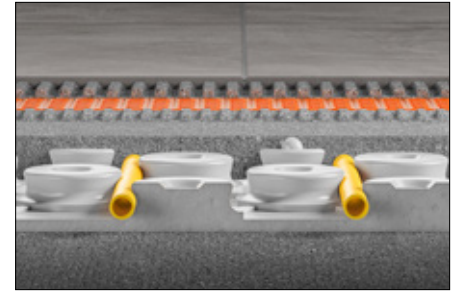
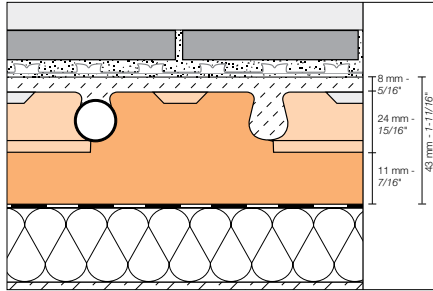
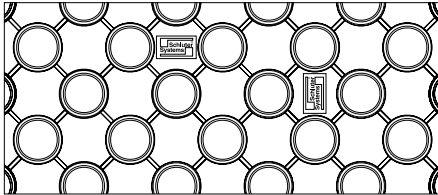

Schluter®-BEKOTEC			
Studded screed panel			35 mm - 1-3/8"
Item No.	Dimensions/Sheet	Packaging	\$ / Box
EN/US/P	61 x 122 cm = 0.74 m ² - 24" x 48" = 8 ft ²	12 sheets / box	245.77

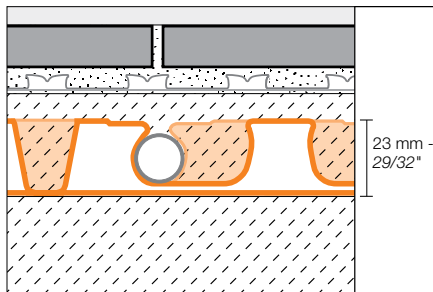

Schluter®-BEKOTEC-F			
Studded screed panel			23 mm - 29/32"
Item No.	Dimensions/Sheet	Packaging	\$ / Box
EN23F10	120 x 90 cm = 1.08 m ² 47-1/4" x 35-7/16" = 11.63 ft ²	10 sheets / box	380.96



BRS

Schluter®-BEKOTEC-BRS		
Edge strip for conventional screed		
Item No.	Dimensions	\$ / Roll
BRS 810	50 m roll: 10 cm wide x 8 mm thick 164' roll: 4" wide x 5/16" thick	91.42



BRSK

Schluter®-BEKOTEC-BRSK		
Edge strip for conventional screed, with adhesive strip		
Item No.	Dimensions	\$ / Roll
BRSK 810	50 m roll: 10 cm wide x 8 mm thick 164' roll: 4" wide x 5/16" thick	118.84

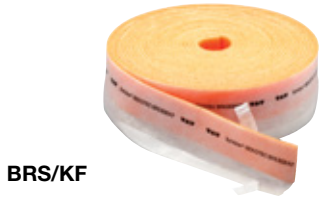

BRS/KF

Schluter®-BEKOTEC-BRS/KF		
Edge strip for poured screeds, with PE-adhesive leg		
Item No.	Dimensions	\$ / Roll
BRS 808 KF	25 m roll: 8 cm wide x 8 mm thick 82' roll: 3-1/8" wide x 5/16" thick	172.65

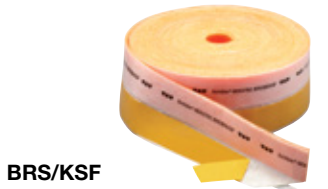

BRS/KSF

Schluter®-BEKOTEC-BRS/KSF		
Self-supporting edge strip for poured screed, with PE-adhesive leg		
Item No.	Dimensions	\$ / Roll
BRS 808 KSF	25 m roll: 8 cm wide x 8 mm thick 82' roll: 3-1/8" wide x 5/16" thick	233.09

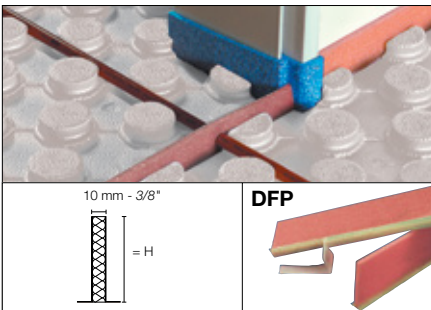

Schluter®-DILEX-DFP		
Length = 1 m - 3' 3"		
Movement joint profile for installation at door areas or for dividing screed surfaces		
H = mm - in.	Item No.	\$ / Length
60 - 2-3/8	DFP 6/100	17.62
80 - 3-1/8	DFP 8/100	21.13
100 - 4	DFP 10/100	24.63

Schluter®-BEKOTEC-THERM-RH 75

Schluter®-BEKOTEC-THERM-RH 75 is a PVC clamp used to attach radiant heating tubes to the BEKOTEC-EN/US/P (1-3/8" - 35 mm)-thick panels. While the studs on the BEKOTEC panel are designed to hold the tubes in place, the clamp is especially useful for forming 45° angles with heating tubes in the studded panel.



Schluter®-BEKOTEC-THERM-RH 75		
Heating Clamps		
Item No.	Quantity	\$ / pkg
BTZRH75/100	100 units / pkg	73.52



Schluter® Setting Materials

Premium quality thin-set mortars & primers

Schluter Systems' thin-set mortars are specifically formulated for use with Schluter membranes and boards. Unmodified, modified, and rapid-setting versions are available. All are sag-resistant, smooth and creamy, easy to handle and spread, and suitable for use with ceramic, porcelain, and stone tile, including large and heavy tile, in conjunction with Schluter Systems' uncoupling and waterproofing membranes (e.g., DITRA, DITRA-HEAT, and KERDI), the Schluter Shower System, and KERDI-BOARD.

PRIMER-U is a ready-to-use universal primer and PRIMER-PS is specially formulated for use with peel and stick membranes.



Schluter®-SET

Schluter®-SET is a premium unmodified thin-set mortar specifically formulated for use with Schluter® membranes and boards. It is sag-resistant, smooth and creamy, and easy to handle and spread. Schluter®-SET is suitable for use with ceramic, porcelain, and stone tile, including large and heavy tile, in conjunction with Schluter®-Systems' uncoupling and waterproofing membranes (e.g., DITRA, DITRA-HEAT, and KERDI), the Schluter®-Shower System, and Schluter®-KERDI-BOARD.

Schluter®-SET meets the requirements of ANSI A118.1, and is available in both grey and white.



Schluter®-SET			
Premium unmodified mortar			
Item No.	Color	Weight	\$ / Unit
SET50G	Grey	22.7 kg - 50 lbs	Please contact your local Schluter supplier for pricing
SET50W	White	22.7 kg - 50 lbs	

WARNING: Cancer and Reproductive Harm – www.P65Warnings.ca.gov

Schluter®-ALL-SET

Schluter®-ALL-SET is a specialized modified thin-set mortar specifically formulated for use with Schluter® membranes and boards. It is engineered for use both under and over all DITRA and KERDI products. It is sag-resistant, smooth and creamy, and easy to handle and spread. ALL-SET is suitable for use with ceramic, porcelain, and stone tile, including large and heavy tile, in conjunction with Schluter®-Systems' uncoupling and waterproofing membranes (e.g., DITRA, DITRA-HEAT, and KERDI), the Schluter®-Shower System, and Schluter®-KERDI-BOARD.

ALL-SET meets the requirements of ANSI A118.4, A118.11, and A118.15, and is available in both grey and white.



Schluter®-ALL-SET			
Specialized modified mortar			
Item No.	Color	Weight	\$ / Unit
SETA50G	Grey	22.7 kg - 50 lbs	Please contact your local Schluter supplier for pricing
SETA50W	White	22.7 kg - 50 lbs	

WARNING: Cancer and Reproductive Harm – www.P65Warnings.ca.gov

Schluter®-FAST-SET

Schluter®-FAST-SET is a specialized rapid-setting modified thin-set mortar specifically formulated for use with Schluter® membranes and boards. It is engineered for use both under and over all DITRA and KERDI products. FAST-SET is ready to grout in 4 hours for fast-track projects. It is sag-resistant, smooth and creamy, and easy to handle and spread. FAST-SET is suitable for use with ceramic, porcelain, and stone tile, including large and heavy tile, in conjunction with Schluter®-Systems' uncoupling and waterproofing membranes (e.g., DITRA, DITRA-HEAT, and KERDI), the Schluter®-Shower System, and Schluter®-KERDI-BOARD.

FAST-SET meets the requirements of ANSI A118.4TF, A118.11, and A118.15TF, and is available in both grey and white.



Schluter®-FAST-SET			
Specialized rapid-setting mortar			
Item No.	Color	Weight	\$ / Unit
SETF50G	Grey	22.7 kg - 50 lbs	Please contact your local Schluter supplier for pricing
SETF50W	White	22.7 kg - 50 lbs	

WARNING: Cancer and Reproductive Harm – www.P65Warnings.ca.gov



Quantity per pallet is 56 bags. Minimum order is 4 pallets.

Special freight conditions apply, please see Conditions of Sale on pages 207 - 208 for details.

Bundle offers for thin-set pallets with other products (i.e. DITRA and KERDI) are available, and are eligible for free shipping.

Please consult a Schluter Sales Representative for more details.



Suitable Uses

Schluter®-DITRA and DITRA-HEAT over	Schluter®-SET	Schluter®-ALL-SET	Schluter®-FAST-SET
Plywood/OSB	X	✓	✓
Concrete	✓	✓	✓
Gypsum	✓	✓	✓
Vinyl flooring	X	X	✓
Schluter®-KERDI over			
Gypsum board	✓	✓	✓
Cement backerboard	✓	✓	✓
Fiber-cement board	✓	✓	✓
Portland cement mortar	✓	✓	✓
KERDI-SHOWER prefabricated substrates	✓	✓	✓
TILE over DITRA, DITRA-HEAT, KERDI and KERDI-BOARD			
Ceramic	✓	✓	✓
Porcelain	✓	✓	✓
Natural stone (e.g., granite, marble, etc.)	✓	✓	✓

- For Schluter®-Systems applications, refer to the Schluter®-DITRA, Schluter®-DITRA-HEAT, and Schluter®-Shower System Installation Handbooks.
- For other applications, refer to TCNA Handbook for Ceramic, Glass, and Stone Tile Installation and TTMAC Specification Guide 09 30 00 Tile Installation Manual.
- Contact Schluter®-Systems Technical Services for installation of glass tile, resin-backed tile, and/or moisture sensitive stone.

✓ = Approved use X = Not recommended

Coverage

Membrane-to-substrate		
Schluter®-DITRA-TROWEL 4.5 mm x 4.5 mm - 11/64" x 11/64"	Schluter®-DITRA-HEAT/-XL-TROWEL 6 mm x 6 mm - 1/4" x 1/4"	Schluter®-KERDI-TROWEL 3 mm x 3 mm - 1/8" x 1/8"
13.9 m ² - 150 ft ²	9.3 m ² - 100 ft ²	18.6 m ² - 200 ft ²

Tile-to-membrane			
Trowel	Schluter®-DITRA/DITRA-HEAT	Schluter®-DITRA-XL	Schluter®-KERDI/KERDI-BOARD
6 mm x 6 mm - 1/4" x 1/4"	5.6 - 6.5 m ² - 60 - 70 ft ²	4.2 - 5.1 m ² - 45 - 55 ft ²	8.4 - 9.3 m ² - 90 - 100 ft ²
6 mm x 9.5 mm - 1/4" x 3/8"	3.7 - 4.6 m ² - 40 - 50 ft ²	3.3 - 4.2 m ² - 35 - 45 ft ²	5.1 - 6.0 m ² - 55 - 65 ft ²
12.5 mm x 12.5 mm - 1/2" x 1/2"	2.8 - 3.7 m ² - 30 - 40 ft ²	2.3 - 3.3 m ² - 25 - 35 ft ²	3.7 - 4.6 m ² - 40 - 50 ft ²
19 mm - 3/4"	2.3 - 3.3 m ² - 25 - 35 ft ²	1.9 - 2.8 m ² - 20 - 30 ft ²	2.8 - 3.7 m ² - 30 - 40 ft ²

Values are approximate

Schluter®-PRIMER-U

Schluter®-PRIMER-U is a ready-to-use, one-component, solvent-free, 100% acrylic, water-based, universal primer. It is used to enhance adhesion properties when applying Schluter thin-set mortars to difficult-to-bond-to surfaces such as gypsum underlayment, raised access panels, and existing tile. PRIMER-U is suitable for use with Schluter SET, ALL-SET, and FAST-SET thin-set mortars, as well as DITRA-PS, DITRA-HEAT-PS, and DITRA-HEAT-DUO-PS peel and stick membranes in interior applications where increased adhesion is required over various porous and non-porous substrates. PRIMER-U is freeze/thaw stable.

PRIMER-U was evaluated according to Rule 1168 from the South Coast Air Quality Management District and found to comply with the VOC requirements.

Suitable Substrates:

- Gypsum underlayment
- Concrete
- Existing tile
- Glass tile
- Plywood and OSB
- Terrazzo
- Steel
- VCT flooring
- Well-bonded flooring adhesive residue
- Latex paint
- Epoxy
- Aluminum
- Resin-backed mosaic tiles
- Asphalt-based cutback adhesive



Schluter®-PRIMER-U			
Universal primer			
Item No.	Quantity	Coverage	\$ / Unit
PRM U QT1	946 ml – 1 Qt.	5 - 12.5 m ² – 50 - 135 ft ²	27.22
PRM U 1	3.78 L – 1 Gal.	23 - 51 m ² – 250 - 550 ft ²	74.86

⚠ WARNING: Cancer and Reproductive Harm – www.P65Warnings.ca.gov



The case quantity of the 1 quart (946 ml) format of PRIMER-U (PRMUQT1) is 12 units.

The case quantity of the 1 gallon (3.78 L) format of PRIMER-U (PRMU1) is 4 units.



Schluter®-PRIMER-PS

Schluter®-PRIMER-PS is a ready-to-use, one-component, solvent-free, water-based primer formulated to enhance the bond of Schluter peel and stick membranes to difficult-to-bond-to surfaces such as OSB, plywood, gypsum concrete, or vinyl. PRIMER-PS is suitable for use with Schluter®-DITRA-PS, DITRA-HEAT-PS, and DITRA-HEAT-DUO-PS peel and stick membranes and can be used in interior applications where increased adhesion is required over various porous and non-porous substrates. PRIMER-PS is freeze/thaw stable and contains zero VOCs.



Suitable Substrates:

- Concrete (above, below, and on grade)
- Plywood and OSB
- Gypsum underlayment
- Ceramic tile
- Porcelain tile
- Quarry tile
- Glass tile
- Terrazzo
- Steel

Schluter®-PRIMER-PS			
Primer for peel and stick membranes			
Item No.	Quantity	Coverage	\$ / Unit
PRM PS QT1	946 ml – 1 Qt.	5 - 10.5 m ² – 50 - 113 ft²	19.89
PRM PS 1	3.78 L – 1 Gal.	23 - 42 m ² – 250 - 450 ft²	55.12

⚠ WARNING: Cancer and Reproductive Harm – www.P65Warnings.ca.gov



The case quantity of the 1 quart (946 ml) format of PRIMER-PS (PRMPSQT1) is 12 units.
The case quantity of the 1 gallon (3.78 L) format of PRIMER-PS (PRMPS1) is 4 units.

Schluter Primer Comparison Chart

Property	PRIMER-PS	PRIMER-U
Primer Type	Topical	Penetrating
Solids Content	30%	20%
Viscosity	100-120 cP	75-100 cP
Color	Gray	Orange
Dry Time	10 - 60 minutes	15 - 60 minutes
VOC	<1 gram/liter per SCAQMD Rule 1168	<1 gram/liter per SCAQMD Rule 1168
Coverage	250 – 450 sq ft per gallon	250 - 550 sq ft per gallon
Preferred Application Method	1/4" nap roller	3/8" nap roller
Relative Humidity	< 85%	< 85%
MVER (Moisture Vapor Emission Rate)	8 lbs per 1000 sq ft	8 lbs per 1000 sq ft
Application Area	Peel and stick membranes	Thin-set / Peel and stick membranes

Schluter®-TROWEL

The **Schluter®-DITRA-TROWEL**, **KERDI-TROWEL**, and **DITRA-HEAT/-DITRA-XL-TROWEL** feature square-notched designs to effectively install DITRA, KERDI, DITRA-XL, DITRA-HEAT, and DITRA-HEAT-DUO, respectively.

DITRA-TROWEL features a 11/64" x 11/64" (4.5 mm x 4.5 mm) square notch.

KERDI-TROWEL features a 1/8" x 1/8" (3 mm x 3 mm) square notch.

DITRA-HEAT/-DITRA-XL-TROWEL features a 1/4" x 1/4" (6 mm x 6 mm) square notch.

All Schluter® Trowels are made of uncoated stainless steel, making them even more durable.



Schluter®-TROWEL		
Item No.	Notch Size	\$ / Unit
KERDI		
TRL-KER	3 mm x 3 mm - 1/8" x 1/8"	34.83
DITRA		
TRL-DIT	4.5 mm x 4.5 mm - 11/64" x 11/64"	34.83
DITRA-HEAT/-DITRA-XL		
TRL-DHXL	6 mm x 6 mm - 1/4" x 1/4"	34.83

Schluter®-DITRA-ROLLER

Schluter®-DITRA-ROLLER is used to embed DITRA and DITRA-HEAT membranes in the bond coat during installation. The lightweight DITRA-ROLLER features a 14-1/2" (37 cm) wide roller and a shelf for placing 50 to 75 lbs of weight (e.g., bag of thin-set mortar or grout, box of tiles, etc.). Between uses, it can be conveniently disassembled for transport and storage.



Schluter®-DITRA-ROLLER	
Item No.	\$ / Unit
DIRO	269.68



Schluter®-SNIPS

Schluter®-SNIPS are specifically designed to cut PVC trim profiles.



Schluter®-SNIPS	
Item No.	\$ / Unit
PSF	93.10
Replacement blade	
PS 90/45 EK	28.49

Schluter®-PROCUT-TSM

Schluter®-PROCUT-TSM is a cutting wheel with a diameter of 4-1/2" (115 mm) for conventional angle grinders. It produces especially clean cuts of stainless steel, aluminum, and brass.

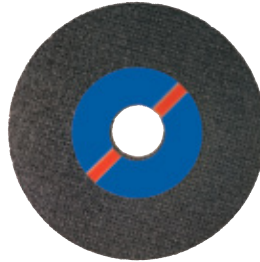

Schluter®-PROCUT-TSM	
Item No.	\$ / Unit
TSM 115/1	15.01

Material Properties and Areas of Application

Schluter® profiles are resistant to most chemicals encountered in tiled environments. In special cases, the suitability of a proposed type of material must be verified based on the anticipated chemical, mechanical, and/or other stresses. Exceptions and special considerations are listed below.

Stainless steel profiles are roll-formed, resulting in a slightly different contour from those made of extruded brass or aluminum. Stainless steel can sustain high mechanical stresses and is particularly well suited for applications requiring resistance against chemicals and acids; for example in the food industry, breweries, dairies, commercial kitchens, and hospitals, as well as in residential applications. Typically, the profiles are formed using stainless steel 304 (1.4301 = V2A). For more severe chemical exposure, such as de-icing salts and chemicals used in swimming pools, we recommend the use of stainless steel 316 L (1.4404 = V4A), which offers even higher corrosion resistance than the 304. Even stainless steel cannot withstand all chemical exposures, such as hydrochloric acid, hydrofluoric acid or certain chlorine, chloride and brine concentrations.

Solid brass sustains high levels of mechanical stress; for example, as edge protection for outside wall corners or edges of surface coverings. Brass is resistant to most chemicals used in tiled environments. Solid brass that is

exposed to air will oxidize, resulting in a natural patina. If exposed to moisture or aggressive substances, heavy oxidation and spotting may occur.

Chrome-plated brass is especially suited for wall corners and finishing applications. It is ideal for matching chrome fixtures. Surface areas must be protected against abrasion or scratching.

Aluminum profiles must be tested to verify their suitability if chemical stresses are anticipated. Cementitious materials, in conjunction with moisture, become alkaline. Since aluminum is sensitive to alkaline substances, exposure to the alkali (depending on the concentration and duration of exposure) may result in corrosion (aluminum hydroxide formation). Therefore, it is important to remove mortar or grout residue from visible surfaces. In addition, ensure that the profile is solidly embedded in the setting material and that all cavities are filled to prevent the collection of alkaline water.

Anodized aluminum profiles feature an anodized layer that retains a uniform appearance during normal use. The surface, however, is susceptible to scratching and wear and may be damaged by grout or setting material. Therefore, these materials must be removed immediately. Otherwise, the description regarding aluminum applies.

Color-coated aluminum and **textured color-coated aluminum** are pretreated (chromated) aluminum that is color-coated with a polyurethane powder coat. The coating is color-stable, UV-resistant, and suitable for exterior use. Protect the profile against abrasion or scratching.

PVC profiles are made of pre-colored, rigid PVC that resists bending or scratching. The material is UV-resistant, though not permanently color-stable, in exterior applications. PVC profiles are not suited for corners or transitions subjected to heavy mechanical stresses (e.g., at step edges or floor transitions).

Note: Due to variations in raw materials and manufacturing, the exact color, shade, and/or texture of individual profiles and related components (e.g., corners, end caps, connectors, etc.) may vary. The customer must inspect the products upon delivery and notify Schluter in writing of any physical damage to the products or nonconformity with the purchase order or invoice.

STAINLESS STEEL, CHROME-PLATED BRASS, AND SOLID BRASS

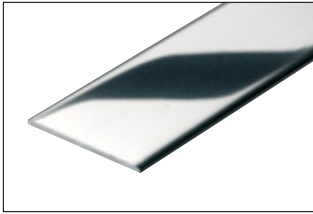

E Stainless steel 304 (1.4301=V2A)
High-grade stainless steel 316 L
(1.4404=V4A)

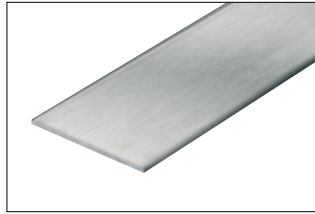

EB Brushed stainless steel

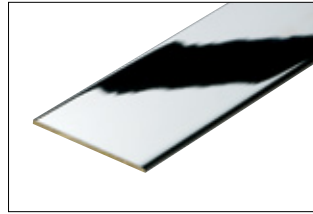

MC Chrome-plated solid brass

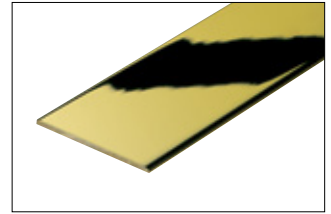

M Solid brass

ALUMINUM

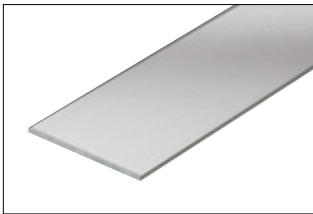

A Aluminum

ANODIZED ALUMINUM

Polished and bright anodized aluminum

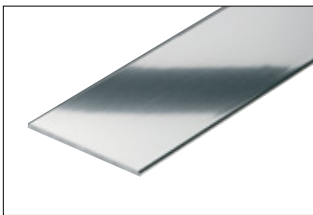

ACG Polished chrome
anodized aluminum
ACB Bright chrome
anodized aluminum

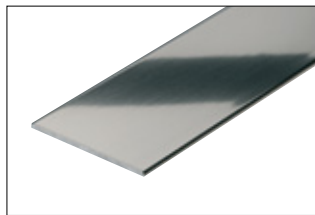

ATG Polished nickel
anodized aluminum

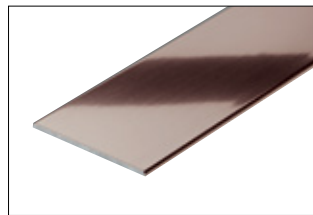

AKG Polished copper
anodized aluminum

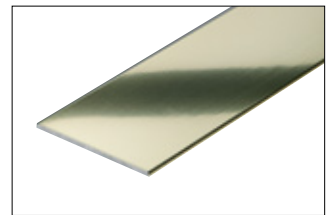

AMG Polished brass
anodized aluminum

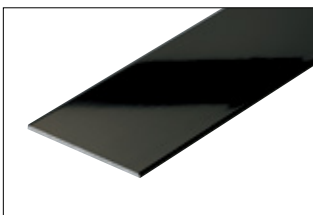

AGSG Bright black
anodized aluminum

Note: Due to variations in raw materials and manufacturing, the exact color, shade, and/or texture of individual profiles and related components (e.g., corners, end caps, connectors, etc.) may vary. The customer must inspect the products upon delivery and notify Schluter in writing of any physical damage to the products or nonconformity with the purchase order or invoice.

Satin anodized aluminum

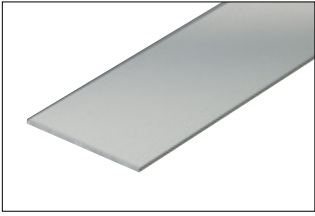

AE Satin anodized aluminum

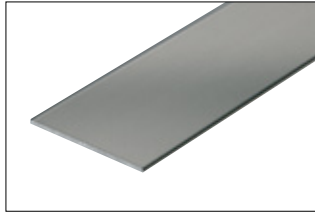

AT Satin nickel anodized aluminum

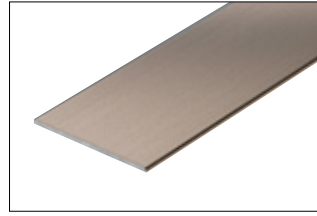

AK Satin copper anodized aluminum

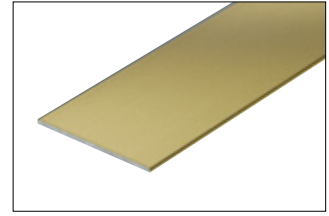

AM Satin brass anodized aluminum

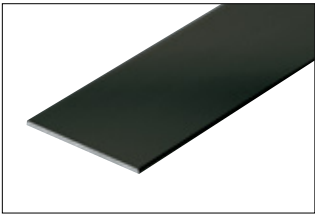

AGR Graphite anodized aluminum

Brushed anodized aluminum

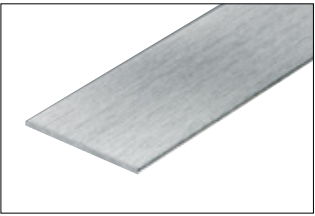

ACGB Brushed chrome anodized aluminum

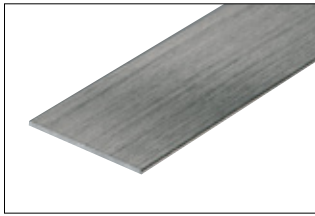

ATGB Brushed nickel anodized aluminum

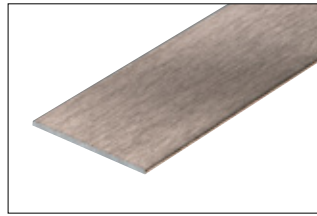

AKGB Brushed copper anodized aluminum

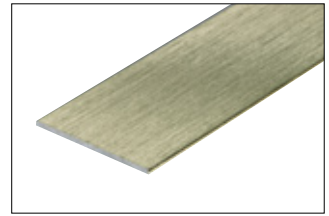

AMGB Brushed brass anodized aluminum

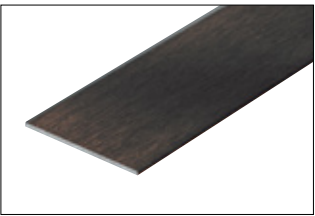

ABGB Brushed antique bronze anodized aluminum

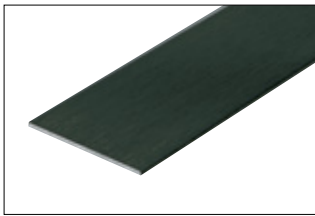

AGRB Brushed graphite anodized aluminum

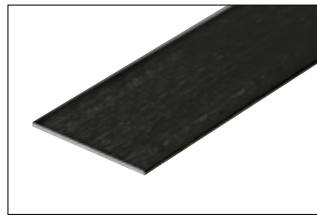

AGSB Brushed black anodized aluminum

Note: Due to variations in raw materials and manufacturing, the exact color, shade, and/or texture of individual profiles and related components (e.g., corners, end caps, connectors, etc.) may vary. The customer must inspect the products upon delivery and notify Schluter in writing of any physical damage to the products or nonconformity with the purchase order or invoice.

TEXTURED COLOR-COATED ALUMINUM

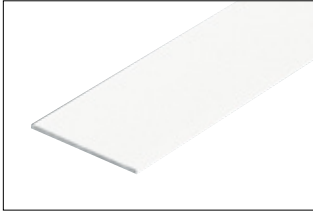

MBW Matte white textured color-coated aluminum
RAL 9003

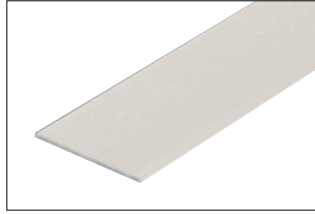

TSI Ivory textured color-coated aluminum

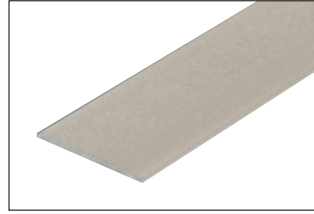

TSBG Greige textured color-coated aluminum

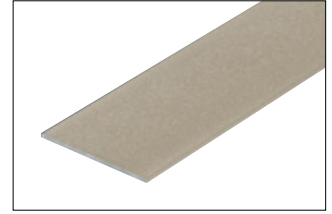

TSC Cream textured color-coated aluminum



TSB Beige textured color-coated aluminum

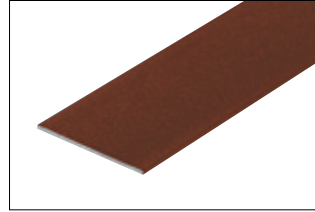

TSR Rustic brown textured color-coated aluminum

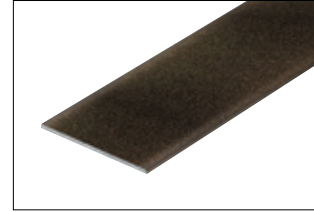

TSOB Bronze textured color-coated aluminum

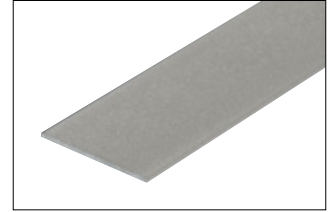

TSSG Stone grey textured color-coated aluminum

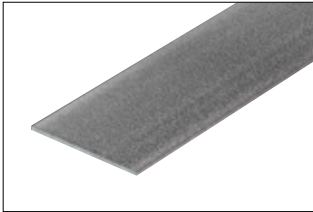

TSG Pewter textured color-coated aluminum



TSLA Light anthracite textured color-coated aluminum



TSDA Dark anthracite textured color-coated aluminum



MGS Matte black textured color-coated aluminum
RAL 9005

Note: Due to variations in raw materials and manufacturing, the exact color, shade, and/or texture of individual profiles and related components (e.g., corners, end caps, connectors, etc.) may vary. The customer must inspect the products upon delivery and notify Schluter in writing of any physical damage to the products or nonconformity with the purchase order or invoice.

COLOR-COATED ALUMINUM

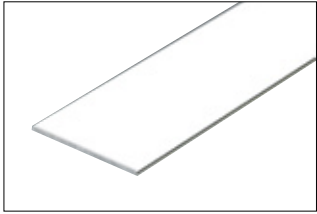

BW Bright white
color-coated aluminum
RAL 9003

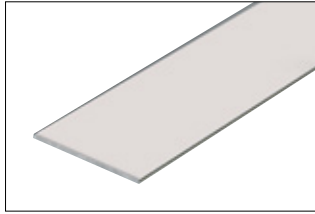

W White
color-coated aluminum
RAL 9010

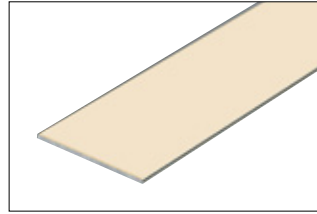

SP Sand pebble
color-coated aluminum
RAL N/A

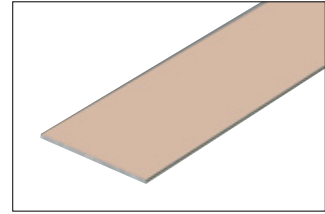

BH Bahama
color-coated aluminum
RAL N/A

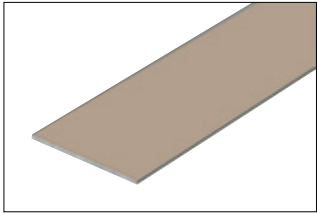

HB Light beige
color-coated aluminum
RAL 1019

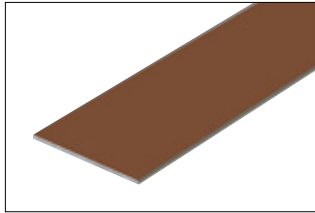

RB Red brown
color-coated aluminum
RAL 8003

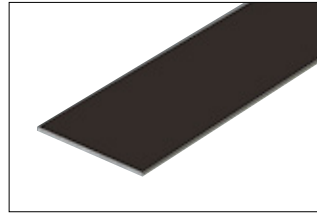

SB Black brown
color-coated aluminum
RAL 8019

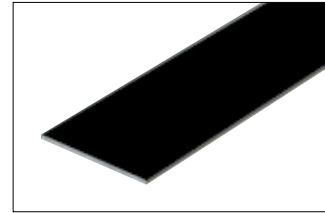

GS Black
color-coated aluminum
RAL 9011

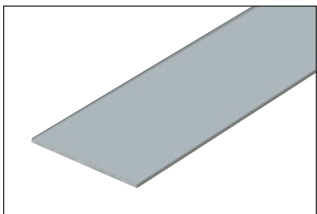

HG Light grey
color-coated aluminum
RAL 7035

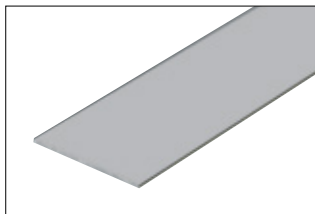

PG Classic grey
color-coated aluminum
RAL N/A

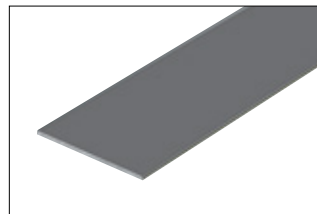

G Grey
color-coated aluminum
RAL 7030

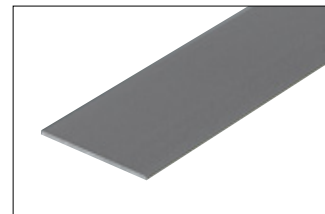

GM Metallic grey
color-coated aluminum
RAL 9006

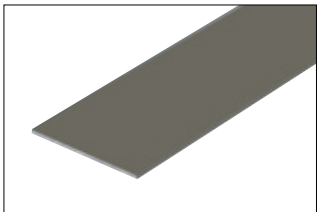

QG Quartz grey
color-coated aluminum
RAL 7039

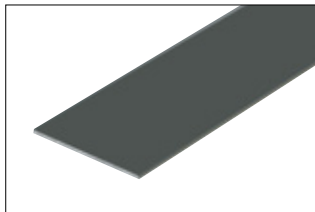

VG Traffic grey
color-coated aluminum
RAL 7043

Note: Due to variations in raw materials and manufacturing, the exact color, shade, and/or texture of individual profiles and related components (e.g., corners, end caps, connectors, etc.) may vary. The customer must inspect the products upon delivery and notify Schluter in writing of any physical damage to the products or nonconformity with the purchase order or invoice.

PVC

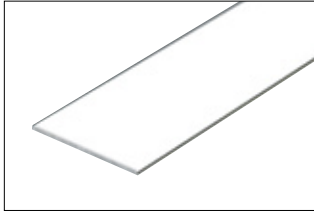

BW Bright white
PVC
RAL 9003

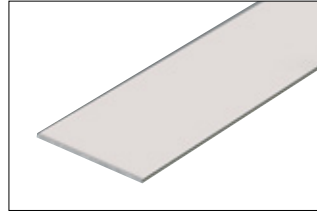

W White
PVC
RAL 9010

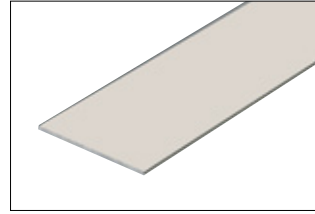

C Cream
PVC
RAL N/A

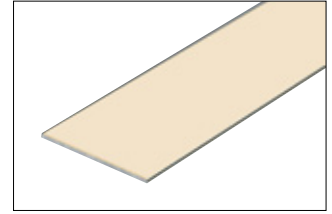

SP Sand pebble
PVC
RAL N/A

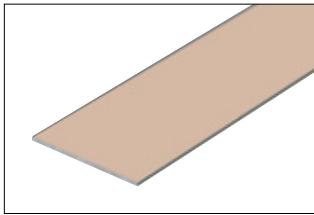

BH Bahama
PVC
RAL N/A

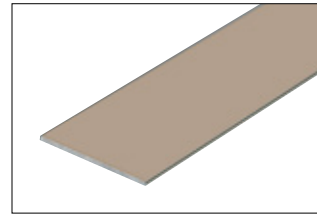

HB Light beige
PVC
RAL 1019

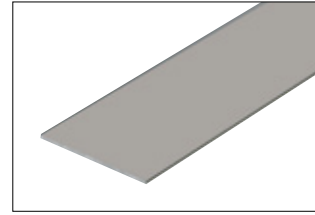

FG Grout grey
PVC
RAL N/A

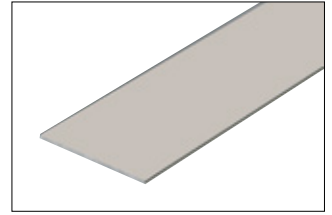

SG Stone grey
PVC
RAL N/A

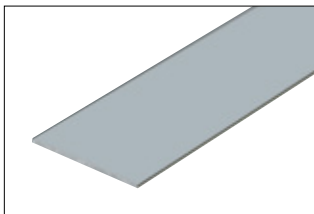

HG Light grey
PVC
RAL 7035

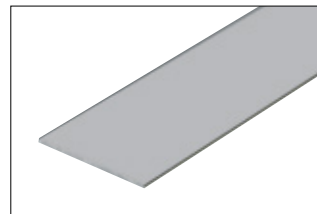

PG Classic grey
PVC
RAL N/A

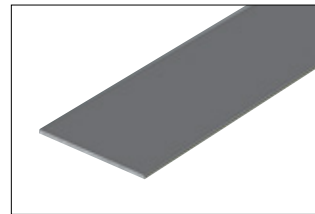

G Grey
PVC
RAL 7030

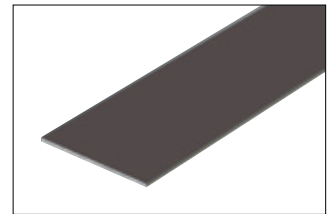

DA Dark anthracite
PVC
RAL N/A

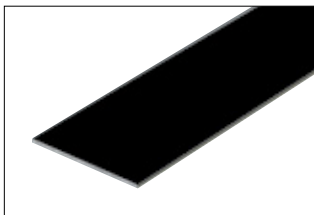

GS Black
PVC
RAL 9011

Note: Due to variations in raw materials and manufacturing, the exact color, shade, and/or texture of individual profiles and related components (e.g., corners, end caps, connectors, etc.) may vary. The customer must inspect the products upon delivery and notify Schluter in writing of any physical damage to the products or nonconformity with the purchase order or invoice.

		Anodized Aluminum																Stainless steel		Insert Color															
Products	Finishes	A	ABGB	ACB	ACG	ACGB	AE	AGR	AGRB	AGSB	AGSG	AK	AKGB	AM	AMGB	AT	ATGB	E	EB	CG	G	GS	HB	NB	SP	FG	SG	HG	T						
		Anodized Aluminum																Stainless steel		Insert Color															
Products	Finishes	A	ABGB	ACB	ACG	ACGB	AE	AGR	AGRB	AGSB	AGSG	AK	AKGB	AM	AMGB	AT	ATGB	E	EB	CG	G	GS	HB	NB	SP	FG	SG	HG	T						
Stair-nosing profiles																																			
RONDEC-STEP																																			
SCHIENE-STEP																																			
TREP-FL																																			
TREP-E/-EK																																			
TREP-G/-GK																																			
TREP-V																																			
TREP-SE/-S/-B																																			
TREP-TAP																																			
PVC and Color-coated Aluminum																																			
Products	Colors	BH	BW	C	C (PVC only)	DA	DA (PVC only)	FG	FG (PVC only)	G	GM	GM (Alum only)	GS	HB	HG	PG	QG	QG (Alum only)	RB	RB (Alum only)	SB	SB (Alum only)	SG	SG (PVC only)	SP	VG	VG (Alum only)	W							
Movement joint and cove-shaped profiles																																			
DILEX-EKE																																			
DILEX-BWA																																			
DILEX-HKW																																			
DILEX-HK																																			
DILEX-PHK																																			
DILEX-BWS																																			
DILEX-BWB																																			
DILEX-F																																			
DILEX-AS																																			
Anodized Aluminum																																			
Products	Finishes	A	ABGB	ACB	ACG	ACGB	AE	AGR	AGRB	AGSB	AGSG	AK	AKGB	AM	AMGB	AT	ATGB	E	EB	M	MC	MBW	MCS	TSB	TSBG	TSC	TSDA	TSG	TSI	TSLA	TSOB	TSR	TSSG		
Movement joint and cove-shaped profiles																																			
DILEX-AHK																																			
DILEX-AHKA																																			
DILEX-EHK/-HKU																																			
DILEX-EDP																																			
DILEX-BT/-STF																																			
DILEX-HKS																																			
DILEX-KSN																																			
DILEX-AKWS																																			
DILEX-KSA																																			
DILEX-EKSB																																			
Profiles for resilient floor and wall coverings																																			
VINPRO																																			

Warranty Program Summary

All Schluter®-Systems products are covered under our warranty program. Products are warranted for the applicable term from the date of purchase only when the products are used and installed in accordance with the terms and conditions of the applicable Schluter®-Systems technical literature and industry standard guidelines that are not in conflict with the technical literature.

There are four different categories of warranties as follows:

Systems

Systems are application based and include a variety of products that form an integrated system. Systems are defined by installation handbooks.

- Schluter®-DITRA, DITRA-PS, and DITRA-XL uncoupling membranes
- Schluter®-DITRA-HEAT and DITRA-HEAT-PS electric floor warming system with integrated uncoupling technology
- Schluter®-Shower System

Lifetime

When you install Schluter®-DITRA/DITRA-PS/DITRA-XL, the Schluter®-Shower System, KERDI/KERDI-DS, DITRA-HEAT/DITRA-HEAT-DUO or DITRA-HEAT-PS/DITRA-HEAT-DUO-PS with one of our Schluter thin-set mortars, your installation may be eligible for limited lifetime warranty coverage.

Consolidated Products

Consolidated products are products with similar characteristics or functions that are grouped under a single warranty document. These product groups are defined by technical data sheets.

- Floor profiles
- Wall and countertop profiles
- Stair-nosing profiles
- Movement joints and cove-shaped profiles
- Resilient floor and wall covering profiles
- Schluter®-BEKOTEC modular screed panels
- Schluter®-KERDI-DRAIN, KERDI-DRAIN-A, KERDI-DRAIN-H, KERDI-DRAIN-F, KERDI-LINE, KERDI-LINE-A and KERDI-LINE-VARIO drains
- Schluter®-KERDI and KERDI-DS waterproofing membranes
- Schluter®-SET, ALL-SET and FAST-SET thin-set mortars

Individual Products

Individual products are those that do not fit into a current consolidated product group and therefore have a separate warranty document. These products are defined by technical data sheets.

- Schluter®-KERDI-BOARD building panels
- Schluter®-KERDI-BOARD-SNLT niches with LED lighting
- Schluter®-LIPROTEC drivers and cables
- Schluter®-REFLEECE removable fleece
- Schluter®-DITRA-HEAT-E thermostats
- Schluter®-KERDI-FIX adhesive/sealant
- Schluter®-PRIMER-U universal primer
- Schluter®-PRIMER-PS peel and stick primer
- Schluter®-DESIGN-NICHE aluminum niches
- Tools

For complete warranty information, please see our website: [Schluter.com/warranty](https://www.schluter.com/warranty).

To obtain hard copies of our warranty documents, please contact Customer Service at 800-472-4588.

CONDITIONS OF SALE

1. Terms and Conditions

These terms and conditions of sale (hereinafter referred to as the "Terms") govern the sale of Products from Schluter Systems L.P. ("Schluter") to Customer where such products are to be used within the United States and its territories. "Products" is defined to mean the products identified on the order confirmation or invoice, whichever is issued later by Schluter to Customer; and "Customer" is defined to mean the purchasing entity identified on such documents. The Terms herein, the terms and conditions contained on any order confirmation and/or invoice, and the terms and conditions contained in any applicable Credit Application, and/or supply agreement between Schluter and Customer, if any, represent the final and complete agreement of Schluter and Customer as to the sale and purchase of Products (the "Agreement"). In the event of any conflicting terms or conditions in the Agreement, the supply agreement, if any, shall be deemed to control; in the absence of a supply agreement, the order confirmation shall be deemed to control. Any and all different or additional terms than those contained in the Agreement are rejected unless expressly accepted in writing by an authorized representative of Schluter.

2. Price and Payment

Payment terms are net thirty (30) days from invoice date. No payments shall be subject to any setoffs, deductions or claims. For any amounts not paid by Customer as of the due date, Customer shall be liable to pay interest on the amount due at a rate of 1.5% per month from due date until date of payment in addition to the principal amount. Regardless of any statement appearing on a check or otherwise, Schluter's acceptance of a payment in an amount less than that due shall in no way be an accord and satisfaction or prejudice Schluter's rights and remedies to collect the full amount due. Prices do not include sales taxes or other charges levied by any governmental authority upon the sale, use or transportation of the Products, all of which shall be paid by Customer, including, without limitation, applicable customs duties and tariffs. Prices quoted in the Price List Catalog are subject to change without prior notice.

For the most current version of the Price List, please visit www.schluter.com.

3. Shipping/Title/Risk of Loss

Unless otherwise expressly set forth in writing by Schluter, all Products will be delivered Ex Works (as defined in Incoterms 2017 revision). Dates of shipments are estimated and not guaranteed. Title and risk of loss to Products shall transfer to Customer upon delivery in accordance with the applicable delivery terms. Any handling of the Products after transfer of risk of loss shall be at Customer's sole risk.

4. Freight and Shipping Charges

Prices quoted in the Price List Catalog include ground freight (best way) charges within the continental USA, save and except for purchase orders under \$10,000 gross at retail, to which freight charges according to the table below will be added thereto.

Ground Freight (Best Way) Charges				
Orders up to \$500	\$500 to \$1,500	\$1,500 to \$3,000	\$3,000 to \$5,000	\$5,000 to \$10,000
\$65	\$85	\$125	\$200	\$300

Schluter offers express shipping to the continental USA; please see applicable table below for options and pricing. Next day and second day shipping is also applicable for Alaska and Hawaii. Please note that "shipping days" represent business days.

Express Handling Freight Charges				
Gross order value at retail	up to \$500	\$500 to \$1,500	\$1,500 to \$3,000	\$3,000 to \$5,000
Next day	\$125	\$220	\$300	\$400
Second day	\$100	\$180	\$275	\$350
Third day	\$85	\$140	\$200	\$260

Express orders greater than \$5,000 gross at retail are charged actual freight.

Certain items with oversized shipping dimensions are not eligible for express shipping. Additionally, certain items (such as 10' profiles) are not eligible for parcel shipping and are subject to an additional \$300 charge unless combined with an order exceeding \$10,000 gross at retail.

Freight charges including air express handling charges are subject to change without prior notice. Please note that we are unable to accommodate third party transport billing.

Accessories:

Accessories include corners and caps for profiles and Rema kits up to \$500 gross at retail:

Regular ground handling	Next-day express handling
\$30	\$50

Accessory orders over \$500 gross at retail are subject to standard shipping charges.

KERDI-BOARD panels:

- 1 to 5 full pallets: \$150/pallet
- 6+ full pallets: free shipping

THIN-SET pallets: minimum order equals 4 full pallets (1 pallet equals 56 bags per item number)

- 4 to 14 full pallets: \$500 freight charge per order
- 15 pallets: free shipping

Bundle offers for thin-set pallets with other products (i.e. DITRA and KERDI) are available and are eligible for free shipping. Please consult with a Schluter Sales Representative for more details.

3rd party shipping (drop shipping):

- Orders to a third party will incur a 10% handling fee.
- THIN-SET only orders to a third party will incur a \$200 handling fee.

5. Product Inspection; Non-conformity

Customer must inspect the Products upon delivery and notify Schluter in writing of any physical damage to the Products or nonconformity with the purchase order or invoice. **FAILURE TO INSPECT AND DELIVER WRITTEN NOTICE OF SUCH DAMAGE OR NONCONFORMITY WITHIN SUCH FORTY EIGHT (48) HOUR PERIOD SHALL CONSTITUTE IRREVOCABLE ACCEPTANCE OF THE DELIVERED PRODUCTS AND A WAIVER OF ANY DAMAGE OR NONCONFORMITY THAT WAS OR SHOULD HAVE BEEN DETECTED.** Any use of the Products or any portion thereof shall constitute irrevocable acceptance of such Products. As Customer's sole remedy for any damaged or nonconforming Products of which Customer has delivered to Schluter timely notice of damaged or nonconforming Products, Schluter, at Schluter's sole election, shall either: (a) replace the damaged or nonconforming Products, or (b) refund the price paid by Customer to Schluter for such damaged or nonconforming Products. In no event shall Schluter be liable for costs of procurement or substitute Products by Customer, or for injury or damage to business, or loss of profits, nor shall Schluter be liable for any incidental, special, indirect, or consequential damages. Any Product images are for illustrative purposes only; any differences between Product images and actual Product received shall not constitute nonconforming Product.

6. Cancellations

If Customer fails to make payment in accordance, or otherwise comply, with all terms of the Agreement, Schluter may, at its option (and in addition to all other remedies), cancel any unshipped portion of Customer's order, without liability to Schluter, and Customer shall remain liable for all unpaid amounts. Subject only to Section 5 herein, orders, once accepted by Schluter, cannot be cancelled without Schluter's prior written consent, which may be granted or withheld in Schluter's sole and absolute discretion. In no event shall Schluter authorize the cancellation or deferment of shipment unless Schluter is indemnified against the loss resulting therefrom. Orders issued a tracking number are considered shipped; any cancellation or deferment will incur a 25% restocking fee.

7. Returns

Schluter shall not accept any returns unless it specifically authorizes such in writing, which may be granted or withheld in Schluter's sole and absolute discretion. Under no circumstances shall Schluter accept any returned Products after thirty (30) days from such Products' invoice date. Any authorized returns must be in resellable condition subject to inspection by Schluter prior to acceptance of same. All authorized returns shall incur a handling charge of 25%.

8. Special Orders

Customer will defend, at its own expense, any suit which may be brought against Schluter by reason of the manufacture or sale of special or non-stock Products made to Customer's specifications, including any third party proceedings. In the case of cancellation of orders of special or non-stock Products, Customer's cancellation may be conditioned upon Customer's payment in full of the price of finished Products. Schluter shall not accept any returns of special or non-stock Products.

9. Warranty and Damages Disclaimer

a. Warranty The Products are covered by product-specific warranties, available at www.schluter.com or Schluter's Warranties Page. The warranty that applies is the applicable warranty in effect for the Products as of the date of the proforma invoice, or if no proforma invoice, as of the date of the order acknowledgement for the Products (the "Written Warranty").

b. Disclaimer THE WRITTEN WARRANTY IS THE ONLY WARRANTY APPLICABLE TO THE PRODUCTS AND EXCLUDES ALL OTHER WARRANTIES, INCLUDING, WITHOUT LIMITATION, ANY IMPLIED WARRANTY OF MERCHANTABILITY OR FITNESS FOR A PARTICULAR PURPOSE, AND ANY IMPLIED WARRANTIES OTHERWISE ARISING FROM A COURSE OF DEALING OR USAGE OF TRADE, EXCEPT WHERE PURCHASE OF THE PRODUCTS IS SUBJECT TO CONSUMER PRODUCT WARRANTY LAWS, IN WHICH INSTANCES ANY APPLICABLE IMPLIED WARRANTIES ARE LIMITED TO THE PERIOD OF THE APPLICABLE WRITTEN WARRANTY, OR SUCH SHORTER PERIOD AS PERMITTED OR REQUIRED UNDER APPLICABLE LAW. IN NO EVENT WILL SCHLUTER BE LIABLE FOR ANY INCIDENTAL, SPECIAL, INDIRECT, OR CONSEQUENTIAL DAMAGES, HOWEVER CAUSED, WHETHER FOR BREACH OF CONTRACT, BREACH OF WARRANTY, TERMINATION, NEGLIGENCE, OR OTHERWISE, EVEN IF SCHLUTER SHALL HAVE BEEN ADVISED OF THE POSSIBILITY OF SUCH DAMAGES. Recommendations, advice, representations, warranties, commitments or agreements that are inconsistent with the foregoing disclaimer shall not be binding on Schluter unless in a writing signed by an authorized representative of Schluter. Schluter's only obligation is to provide the Products in the quantities ordered by Customer (which order is accepted by Schluter) without regard to the Products' appropriateness to Customer's application. Customer represents and warrants that Customer is not a "consumer" as defined by any applicable usury or consumer protection laws.

10. Delay/Force Majeure

Delay in delivery or nondelivery by Schluter shall not be a breach or default by Schluter if performance is delayed or made impracticable or impossible by the occurrence of any one or more of the following: (a) fire, flood, or other casualty, (b) war, riot, embargo, governmental regulation or martial law, (c) inability to obtain necessary materials from usual sources of supply, (d) shortage of transportation or delays in transit, (e) strike or other labor issue, and (f) other conditions not reasonably within Schluter's control, whether or not of a kind mentioned herein.

11. Choice of Law

For sales made in the United States or its territories, the Agreement (including, without limitation, these Terms) shall be governed by the State of New York, without regard for its choice of law provisions.

12. Arbitration

a. Any controversy, claim or dispute arising out of or in connection with the Agreement shall be settled by final and binding arbitration administered by the American Arbitration Association in accordance with its Commercial Arbitration Rules in Plattsburgh, Clinton County, state of New York and judgment on the award rendered by the arbitrator may be entered in any court having jurisdiction. The arbitration shall be heard by a single arbitrator appointed in accordance with the Commercial Arbitration Rules, and shall be conducted in English.

b. If a controversy or claim relates to or is the subject of a mechanic's or construction lien, Schluter may proceed in accordance with applicable law to preserve and enforce its lien rights. TO THE FULLEST EXTENT PERMITTED BY LAW, NOTWITHSTANDING ANY ARBITRATION RULE OR PROCEDURE, (A) NO CONTROVERSY OR CLAIM ARISING OUT OF OR RELATING TO THE AGREEMENT SHALL BE CONSOLIDATED OR JOINED WITH ANY OTHER PERSON'S CLAIM AND NO CLASS ACTION OR REPRESENTATIVE ACTIONS SHALL BE PERMITTED UNDER THE AGREEMENT, AND (B) IF ANY CLASS OR REPRESENTATIVE ACTION CANNOT BE WAIVED UNDER APPLICABLE LAW, THE PARTIES AGREE THAT SUCH ACTION SHALL BE ARBITRATED.

13. Miscellaneous

No amendment, alteration, variation, deletion, addition, and/or cancellation of these Terms made by Customer shall be of any force or effect unless reduced to writing and signed by a director of Schluter. If any clause, subclause, or other provision of these Terms is invalid under any statute or rule of law, such provision, to that extent only, shall be deemed to be omitted without affecting the validity of the remainder of the Terms. Customer shall pay to Schluter all costs of collection, including, without limitation, reasonable attorneys' fees, incurred by Schluter in enforcing the Agreement, including, without limitation, collecting any money due from Customer and enforcing Schluter's lien rights. No waiver by Schluter of any term or any obligation of Customer shall constitute a waiver of any other term or obligation. Customer shall not assign or transfer its rights or obligations under the Agreement without the prior written consent of Schluter. All of Customer's representations, warranties and indemnities under the Agreement shall survive the consummation of or the termination or cancellation of any purchase and sale of Products. Which party prepared the Agreement shall have no bearing on the construction or interpretation of the Agreement. Buyer will defend, at its own expense, any suit or legal proceeding, including any third party proceedings, which may be brought against Schluter by reason of the manufacture or sale of any special product(s) made to Buyer's specifications. These Terms supersede all prior versions of Schluter's Conditions of Sale. Schluter reserves the right in its sole discretion to amend these Terms from time to time and any such amended terms and conditions shall be binding on Customer. For the most current version of the Terms, please visit www.schluter.com/terms.

Copyright Notice

The Schluter-Systems Illustrated Price List is protected by copyright laws. Its entire content, including images and text, may not be reproduced, distributed, modified, reused, or otherwise used without the express written permission of Schluter-Systems.

© 2025 Schluter-Systems. All rights reserved.

Trademark Notice

All product names, logos and/or designs, including but not limited to those listed on our website, schluter.com/trademarks, are owned by Schluter-Systems. It may not be a complete list of trademarks owned by Schluter-Systems as it does not list all common law trademarks and trademark applications or registrations worldwide. The unauthorized use or misuse of these trademarks is expressly prohibited and may be in violation of intellectual property rights which shall be enforced.

Scan here
to download
a digital copy

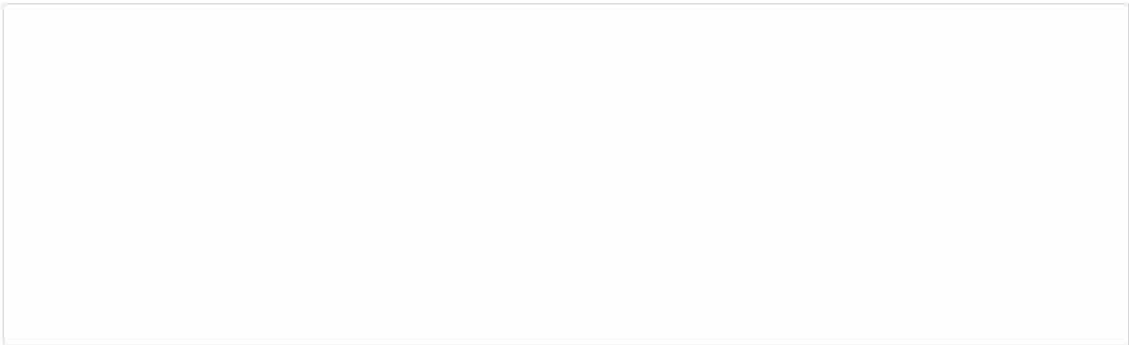

04/2025 © 2025 Schluter-Systems. All rights reserved.

